



head low 120 - 160 - 180 - 200 - 220 - 320 - queen - king / plain - quilt - stripe - diamond - capitonné

· testiere letto a muro h.120 imbottite e sfoderabili - complete di supporti per fissaggio a muro
 · fisse per versione capitonné
 · rivestimenti in tessuto (lavabile solo a secco) o pelle
 · basamento in legno tinto black

testiera cm 320:
 - due pannelli separati (2x cm 160)
 - rivestimento intero (singolo per versione capitonné)
 - basamento in legno tinto black - in tre parti con spazio passacavi

dimensioni speciali a richiesta

· padded headboards for wall-hanging h.120 with removable cover - fittings for wall-hanging included
 · fixed cover for capitonné finish
 · cover in fabric (dry cleaning only) or leather
 · wooden base, black stained

headboard cm 320:
 - 2 single panels (2x cm 160)
 - single cover for 2 panels (separate for capitonné finish)
 · wooden base, black stained - base divided in 3 pieces for cable passage

special sizes: ask for an estimate

· gepolsterte und abziehbare Kopfteile h.120 zur Wandmontage - mit Befestigungsbeschläge für Wandmontage
 · Festbezug für kapitonierte Verarbeitung
 · Bezug aus Stoff (nur Trockenreinigung) oder Leder
 · Holzsockel schwarz gebeizt

Kopfteil Breite cm 320:
 - zwei getrennte Holzpaneele (2x cm 160)
 - durchgehende Housse (getrennt für Kapitoniert)
 · Holzsockel schwarz gebeizt bestehend aus drei Teilen, mit Kabeldurchgang

Sondermass: Angebot nach Anfrage

· têtes de lit au mur h.120 rembourrées et déhoussables - complètes avec supports pour fixation au mur
 · fixes pour version capitonnée
 · revêtement en tissu (nettoyage à sec uniquement) ou cuir
 · base en bois teinté black

tête de lit cm 320:
 - deux panneaux distincts (2x cm 160)
 - revêtement entier (simple pour version capitonnée)
 · base en bois teinté black divisée en trois parties avec passe-câble

dimensions spéciales: sur devis

· cabezales h.120 acolchados y desenfundables con soportes para colgar a pared
 · revestimiento fijo para versión capitonné
 · revestimiento en tela (sólo limpieza en seco) o piel
 · base de madera teñido black

cabezal cm 320:
 - dos paneles separados (2 x cm 160)
 - revestimiento entero (individual para versión capitonné)
 · base de madera teñido black en tres partes con espacio para cables

medidas especiales: pedir presupuesto

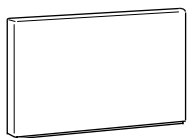

finitura / finish: plain

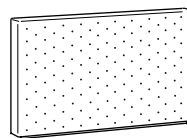

finitura / finish: quilt

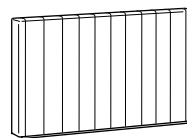

finitura / finish: stripe

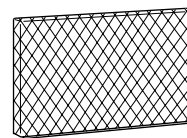

finitura / finish: diamond

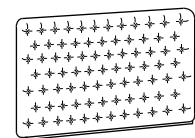

finitura / finish: capitonné

cucitura - stitching

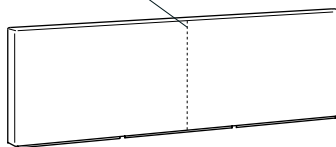

finitura / finish: plain

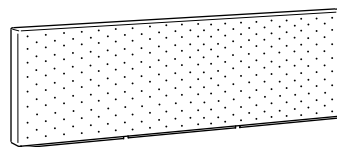

finitura / finish: quilt

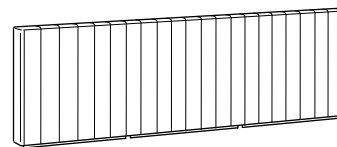

finitura / finish: stripe

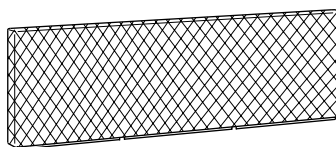

finitura / finish: diamond

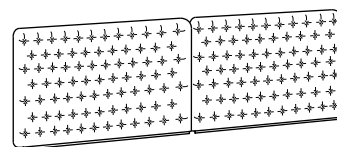

finitura / finish: capitonné

esempi di composizioni / sketches of configuration

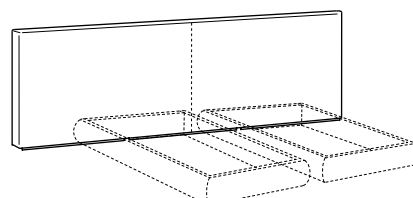
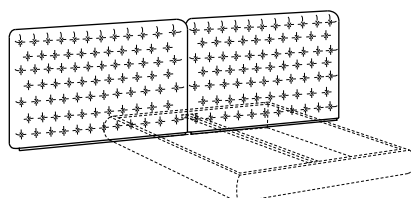
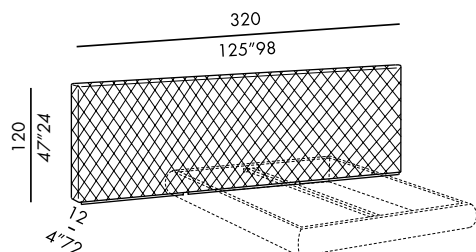
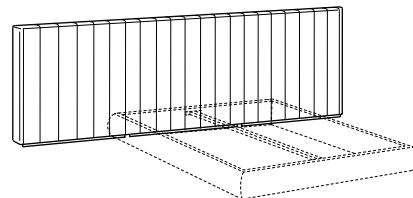
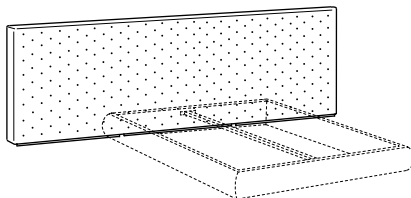
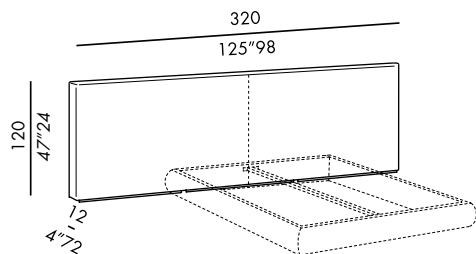
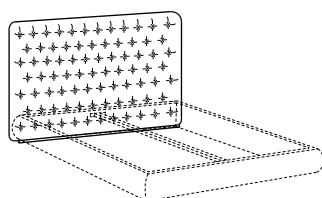
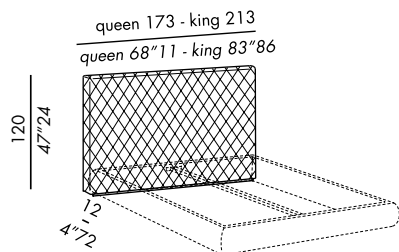
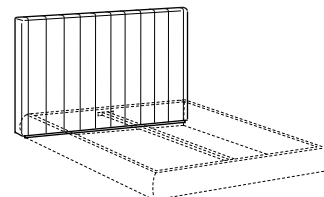
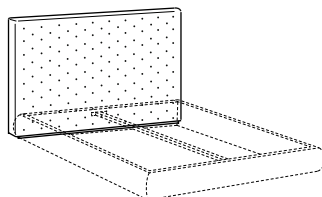
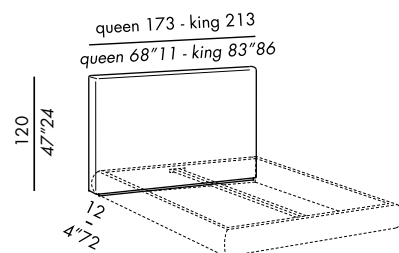
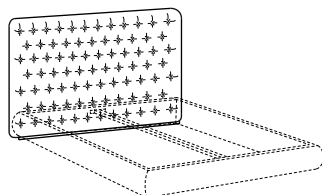
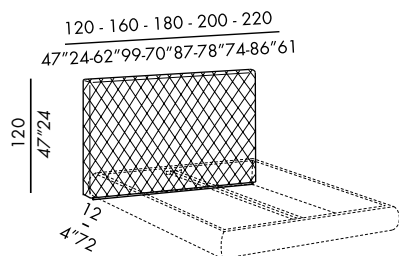
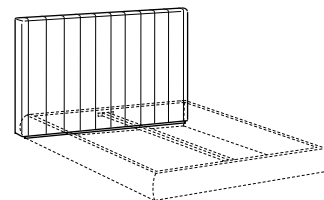
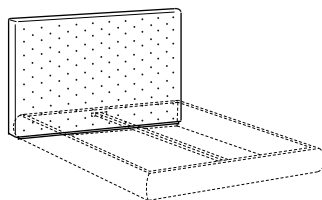
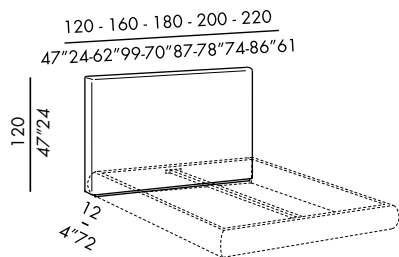



head high 160 - 180 - 200 - 220 - 320 - queen - king / plain - stripe - capitonné

- testiere letto a muro h.160 imbottite e sfoderabili - complete di supporti per fissaggio a muro
- fisse per versione capitonné
- rivestimenti in tessuto (lavabile solo a secco) o pelle
- basamento in legno tinto black

- padded headboards for wall-hanging h.160 with removable cover - fittings for wall-hanging included
- fixed cover for capitonné finish
- cover in fabric (dry cleaning only) or leather
- wooden base, black stained

- gepolsterte und abziehbare Kopfteile h.160 zur Wandmontage - mit Befestigungsbeschläge für Wandmontage
- Festbezug für kapitonierte Verarbeitung
- Bezug aus Stoff (nur Trockenreinigung) oder Leder
- Holzsockel schwarz gebeizt

- têtes de lit au mur h.160 rembourrées et déhoussables - complètes avec supports pour fixation au mur
- fixes pour version capitonnée
- revêtement en tissu (nettoyage à sec uniquement) ou cuir
- base en bois teinté black

- cabezales h.160 acolchados y desenfundables con soportes para colgar a pared
- revestimiento fijo para versión capitonné
- revestimiento en tela (sólo limpieza en seco) o piel
- base de madera teñido black

- testiera cm 320:
- due pannelli separati (2x cm 160)
 - rivestimento intero (singolo per versione capitonné)
 - basamento in legno tinto black - in tre parti con spazio passacavi

- headboard cm 320:
- 2 single panels (2x cm 160)
 - single cover for 2 panels (separate for capitonné finish)
 - wooden base, black stained - base divided in 3 pieces for cable passage

- Kopfteil Breite cm 320:
- zwei getrennte Holzpaneele (2x cm 160)
 - durchgehende Housse (getrennt für Kapitoniert)
 - Holzsockel schwarz gebeizt bestehend aus drei Teilen, mit Kabeldurchgang

- tête de lit cm 320:
- deux panneaux distincts (2x cm 160)
 - revêtement entier (simple pour version capitonnée)
 - base en bois teinté black divisée en trois parties avec passe-câble

- cabezal cm 320:
- dos paneles separados (2 x cm 160)
 - revestimiento entero (individual para versión capitonné)
 - base de madera teñido black en tres partes con espacio para cables

dimensioni speciali a richiesta

special sizes: ask for an estimate

Sondermass: Angebot nach Anfrage

dimensions spéciales: sur devis

medidas especiales: pedir presupuesto

cucitura - stitching

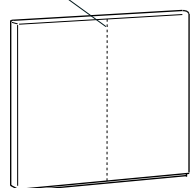

finitura / finish: plain

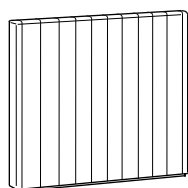

finitura / finish: stripe

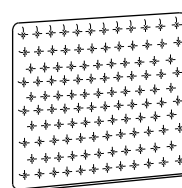

finitura / finish: capitonné

cucitura - stitching

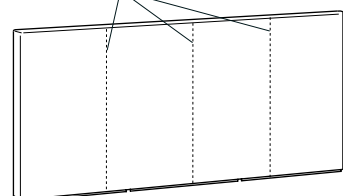

finitura / finish: plain

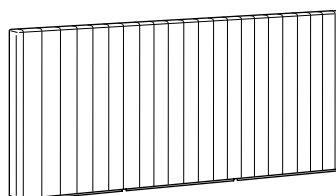

finitura / finish: stripe

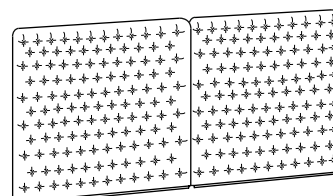

finitura / finish: capitonné

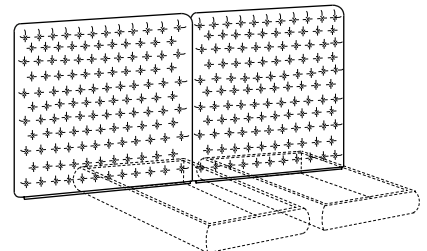
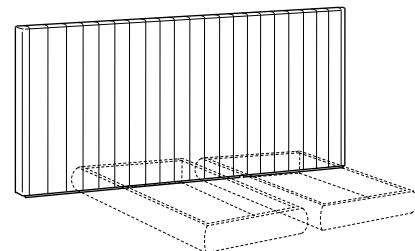
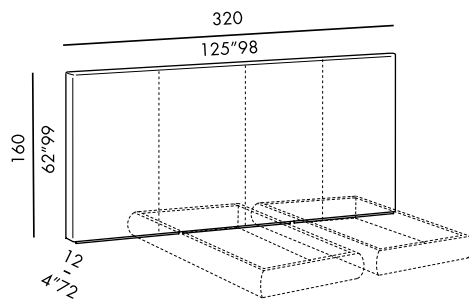
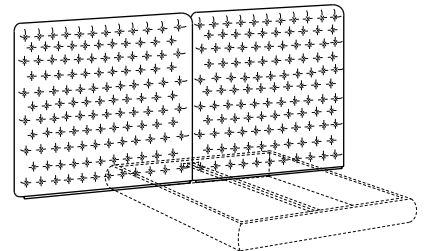
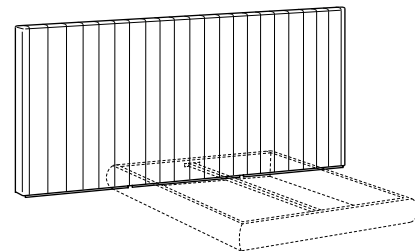
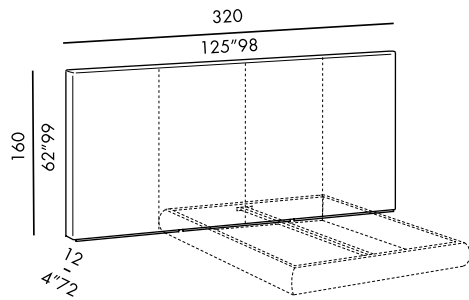
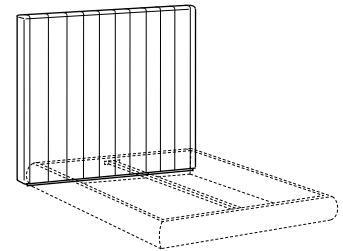
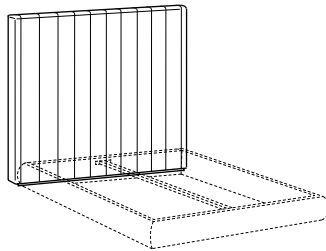
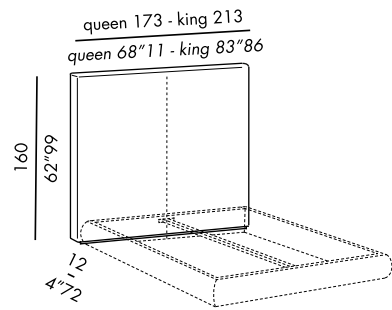
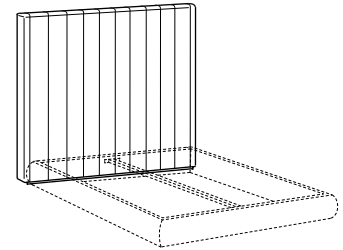
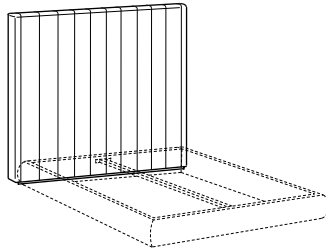
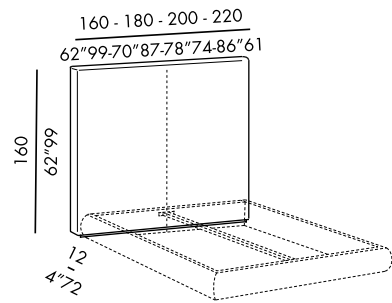



head kuoio 120 - 160 - 180 - 200 - 220

· testiere letto a muro h.120 imbottite -
complete di supporti per fissaggio a muro
· rivestimento in cuoio con chiusura lampo
decorativa a vista
· basamento in legno rivestito in cuoio

· padded headboards for wall-hanging h.120
· fittings for wall-hanging included
· covered in saddle leather with decorative
visible zip
· wooden base covered in saddle leather

· gepolsterte Kopfteile h.120 zur Wandmontage
· mit Befestigungsbeschläge für Wandmontage
· Kernlederbezug mit sichtbarem Deko-
Reißverschluss
· Holzsockel mit Kernleder bezogen

· têtes de lit au mur h.120 rembourrées -
complet avec supports pour fixation au mur
· revêtement en cuir sellier avec zip décoratif
apparente
· base en bois revêtu en cuir sellier

· cabezales h.120 acolchados con
soportes para colgar a pared
· revestimiento en cuero con cremallera de
decoración a vista
· base de madera revestido en cuero

cuoio: vedi campionario

saddle leather: for colours, see sample box

Kernlederfarbe: siehe Musterkarte

cuir sellier: voir boite

cuero: para acabados véase el muestrario

cucitura - stitching

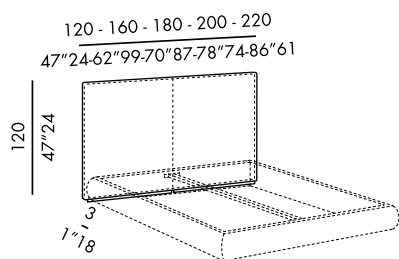
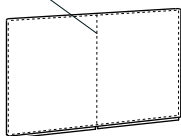

esempio di composizione / sketch of configuration



head kuoio 240 (120+60+60) - 280 (160+60+60) - 300 (180+60+60) - 320 (200+60+60) - 340 (220+60+60) - 440 (160+160+60+60)

- testiere letto a muro h.120 imbottite con ante laterali pieghevoli - complete di supporti per fissaggio a muro
- rivestimento in cuoio con chiusura lampo decorativa a vista
- basamento in legno rivestito in cuoio - con spazio passacavi

- padded headboards for wall-hanging h. 120 with folding side panels - fittings for wall-hanging included
- covered in saddle leather with decorative visible zip
- wooden base covered in saddle leather with cable passage

- gepolsterte Kopfteile h.120 zur Wandmontage, mit seitlichen Flügeln - mit Befestigungsbeschläge für Wandmontage
- Kernlederbezug mit sichtbarem Deko-Reißverschluss
- Holzsockel mit Kernleder bezogen, mit Kabeldurchgang

- têtes de lit au mur h.120 avec volets latéraux pliables - complet avec supports pour fixation au mur
- revêtement en cuir sellier avec zip décoratif apparente
- base en bois revêtue en cuir sellier avec passe-câbles

- cabezales h.120 con paneles laterales plegables - con soportes para colgar a la pared
- revestimiento en cuero con cremallera de decoración a vista
- base de madera revestida en cuero con espacio para cables

cuoio: vedi campionario

saddle leather: for colours, see sample box

Kernlederfarbe: siehe Musterkarte

cuir sellier: voir boite

cuero: para acabados véase el muestrario

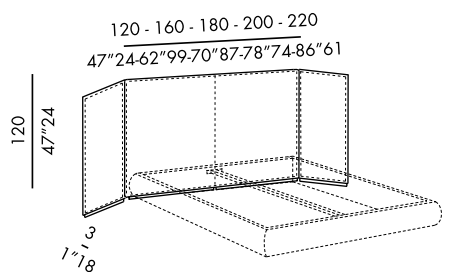
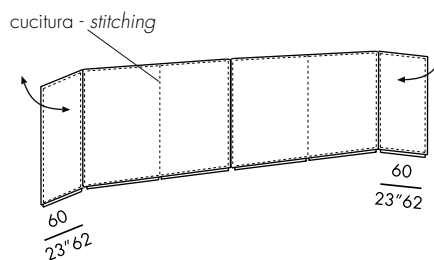
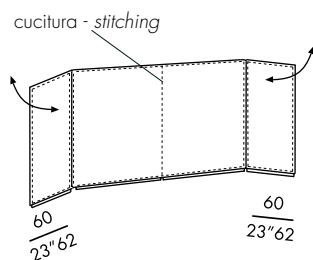

esempio di composizione / sketch of configuration

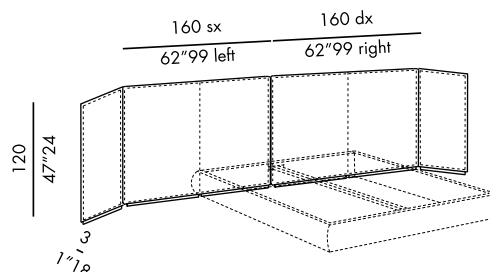

esempio di composizione / sketch of configuration



head slim kuoio 180 - head slim kuoio 200 - head slim kuoio 220 - head slim kuoio 2x95

· testiere letto a muro h.35/60 imbottite -
complete di supporti per fissaggio a muro
· rivestimento in cuoio con chiusura lampo
decorativa a vista

· padded headboards for wall-hanging
h.35/60 - fittings for wall-hanging included
· covered in saddle leather with decorative
visible zip

· gepolsterte Kopfteile h.35/60 zur
Wandmontage - mit Befestigungsbeschläge
für Wandmontage
· Kernlederbezug mit sichtbarem
Deko-Reißverschluss

· têtes de lit au mur h.35/60 rembourrées -
complet avec supports pour fixation au mur
· revêtement en cuir sellier avec zip
décoratif apparente

· cabezales h.35/60 acolchados con
soportes para colgar a pared
· revestimiento en cuero con cremallera de
decoración a vista

cuoio: vedi campionario

saddle leather: for colours, see sample box

Kernlederfarbe: siehe Musterkarte

cuir sellier: voir boîte

cuero: para acabados véase el muestrario

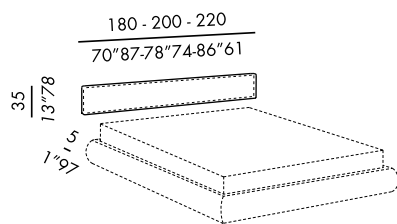

esempio di composizione / sketch of configuration

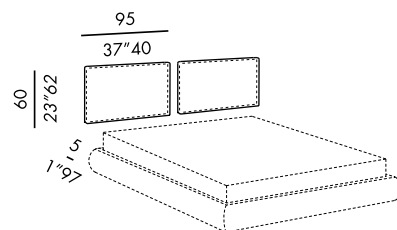
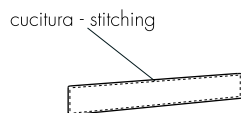

esempio di composizione / sketch of configuration

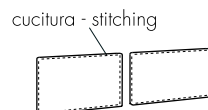



base 15

- base letto imbottita h.30
- rivestimenti sfoderabili in tessuto (lavabile solo a secco) o pelle
- struttura smontabile in legno con traverso centrale in metallo
- piani letto a scelta

misure speciali:
 lunghezza letto max 220 cm - larghezza min 100 max 200 cm (vano interno)
 lunghezza rete elite fissa max 210 cm

versione con 4 lati imbottiti: a richiesta

- padded bed base h.30
- cover in fabric (dry cleaning only) or leather with removable cover
- wooden frame that can be disassembled with metal cross bar
- mattress supports according to choice

special sizes:
 bed max length 220 cm - minimum width 100 cm, max 200 cm (inner size)
 fix elite slatted base max length 210 cm

free-standing version with 4 padded side panels: on request

- gepolsterter Bettrahmen h.30
- Bezug aus Stoff (nur Trockenreinigung) oder Leder
- demontierbare Bettseiten (gepolsterte Holzflächen) mit mittlerer Mittelstange aus Metall
- Unterbett nach Auswahl

Sondermaß:
 Länge des Bettes max. 220 cm · Breite min. 100 max. 200 cm (Innenmaß)
 Länge des Lattenrostes Elite fix max. 210 cm

Bettrahmen mit 4 gepolsterten Seiten: Nach Anfrage

- base de lit rembourrée h.30
- revêtement en tissu (nettoyage à sec uniquement) ou cuir
- structure démontable en bois avec barre centrale in métal

mésures spéciales:
 longueur lit max 220 cm - largeur minimum 100 cm, max 200 cm (dimension intérieure)
 longueur maximum Elite sommier à lattes fixe 210 cm

version avec tous les 4 cotés rembourrés: sur demande

- base cama acolchada h.30
- revestimiento en tela (sólo limpieza en seco) o piel desenfundable
- estructura en madera desmontable con travesaño central en metal
- somieres a elegir

medidas especiales:
 largo cama max 220 cm - ancho min 100 max 200 cm (espacio interior)
 largo somier elite fija max 210 cm

versión con 4 lados acolchados: a petición

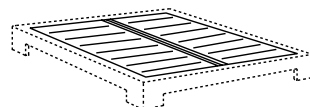
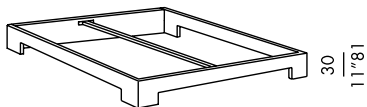

piano ortopedico
 orthopaedic base

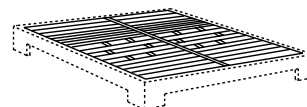

rete elite
 elite slatted base

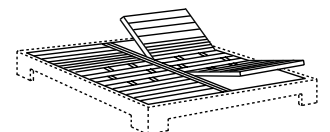

rete elite MM
 elite MM slatted base

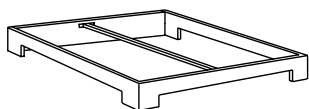

finitura / finish: plain

TUYO®

2013

base 15 - 175x210 (materasso - mattress 160x200)

plain

piani ortopedici - *orthopaedic bases*
2x 79x200 / 2x 31"10x78"74 (coppia - pair)

rete élite - *élite slatted base*
1x 157x200 / 1x 61"81x78"74

reti élite sdoppiate - *single élite slatted bases*
2x 79x200 / 2x 31"10x78"74 (coppia - pair)

reti élite MM - *single élite slatted bases MM*
2x 79x200 / 2x 31"10x78"74 (coppia - pair)

base 15 - 195x210 (materasso - mattress 180x200)

plain

piani ortopedici - *orthopaedic bases*
2x 89x200 / 2x 35"04x78"74 (coppia - pair)

rete élite - *élite slatted base*
1x 177x200 / 1x 69"69x78"74

reti élite sdoppiate - *single élite slatted bases*
2x 89x200 / 2x 35"04x78"74 (coppia - pair)

reti élite MM - *single élite slatted bases MM*
2x 89x200 / 2x 35"04x78"74 (coppia - pair)

base 15 - 215x210 (materasso - mattress 200x200)

plain

piani ortopedici - *orthopaedic bases*
2x 99x200 / 2x 38"98x78"74 (coppia - pair)

rete élite - *élite slatted base*
1x 197x200 / 1x 77"56x78"74

reti élite sdoppiate - *single élite slatted bases*
2x 99x200 / 2x 38"98x78"74 (coppia - pair)

reti élite MM - *single élite slatted bases MM*
2x 99x200 / 2x 38"98x78"74 (coppia - pair)

TUYO® - US

2013

base 15 - queen - 168x213 / 66"x84" (materasso - mattress 153x203)

plain

rete élite - *élite slatted base*
1x 150x202 / 1x 59"x80"

base 15 - ca king - 198x223 / 78"x88" (materasso - mattress 183x213)

plain

rete élite (prezzo su richiesta) - *slatted base (price on request)*

base 15 - king - 208x213 / 82"x84" (materasso - mattress 193x203)

plain

rete élite - *élite slatted base*
1x 190x202 / 1x 75"x80"

MERIDIANI



base 30

- base letto imbottita h.36
 - rivestimenti sfoderabili in tessuto (lavabile solo a secco) o pelle
 - struttura smontabile in legno con traverso centrale in metallo
 - piani letto a scelta con supporti regolabili no per versione box
 - piedini in legno tinto black
- finitura capitonné:
- base letto imbottita con rivestimento fisso
 - struttura in legno non smontabile con traverso centrale in metallo

- padded bed base h.36
 - cover in fabric (dry cleaning only) or leather with removable cover
 - wooden frame that can be disassembled with metal cross bar
 - mattress supports according to choice, height adjustable - not adjustable for storage facility
 - feet in black stained wood
- capitonné finish:
- padded bed base with fix cover
 - wooden frame that can be disassembled with metal cross bar

- gepolsterter Bettrahmen h.36
 - Bezug aus Stoff (nur Trockenreinigung) oder Leder
 - demontierbare Bettseiten (gepolsterte Holzflächen) mit mittlerer Mittelstange aus Metall
 - Unterbett nach Auswahl, mit verstellbaren Trägern - nicht möglich bei Storage Box
 - Holzfüße schwarz gebeizt
- Kapitonierte Verarbeitung:
- gepolsterter Bettrahmen mit festem Bezug
 - demontierbare Bettseiten (gepolsterte Holzflächen) mit mittlerer Mittelstange aus Metall

- base de lit rembourrée h.36
 - revêtement en tissu (nettoyage à sec uniquement) ou cuir
 - structure démontable en bois avec barre centrale en métal
 - bases de lits à choix avec supports réglables, pas pour version box
 - pieds en bois teinté black
- finition capitonné:
- base de lit rembourré avec revêtement fixe
 - structure démontable en bois avec barre centrale en métal

- base cama acolchada h.36
 - revestimiento en tela (sólo limpieza en seco) o piel desenfundable
 - estructura en madera desmontable con travesaño central en metal
 - somieres a elegir con soportes ajustables - no posible para contenedor
 - patas de madera teñido black
- versión capitonné:
- base cama acolchada con revestimiento fijo
 - estructura en madera desmontable con travesaño central en metal

misure speciali:
 lunghezza letto max 220 cm - larghezza min 100 max 200 cm (vano interno)
 lunghezza rete élite fissa max 210 cm

special sizes:
 bed max length 220 cm - minimum width 100 cm, max 200 cm (inner size)
 fix élite slatted base max length 210 cm

Sondermaß:
 Länge des Bettes max. 220 cm . Breite min. 100 max. 200 cm (Innenmaß)
 Länge des Lattenrostes Elite fix max. 210 cm

mésures spéciales:
 longueur lit max 220 cm - largeur minimum 100 cm, max 200 cm (dimension intérieure)
 longueur maximum Elite sommier à lattes fixe 210 cm

medidas especiales:
 largo cama max 220 cm - ancho min 100 max 200 cm (espacio interior)
 largo somier élite fija max 210 cm

versione con 4 lati imbottiti: a richiesta

free-standing version with 4 padded side panels: on request

Bettrahmen mit 4 gepolsterten Seiten: Nach Anfrage

version avec tous les 4 cotés rembourrés: sur demande

versión con 4 lados acolchados: a petición

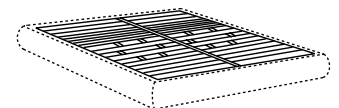
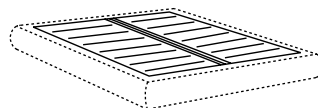
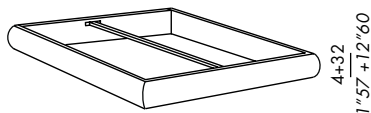

piano ortopedico / orthopaedic base

rete élite / élite slatted base

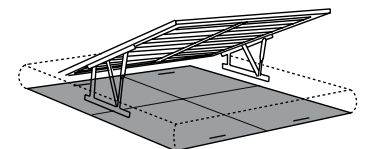
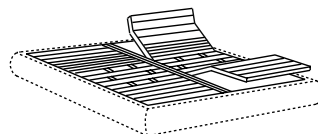
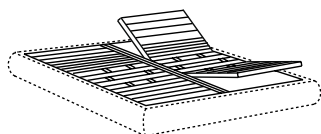

rete élite MM / élite MM slatted base

rete élite ME / élite ME slatted base

storage box - profondità / depth cm.18 - 7*09

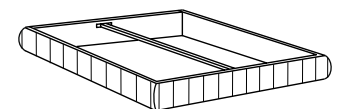
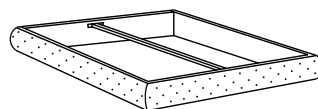
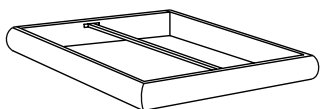

finitura / finish: plain

finitura / finish: quilt

finitura / finish: stripe

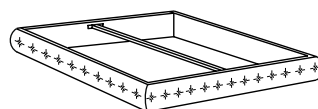
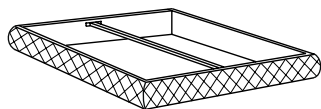

finitura / finish: diamond

finitura / finish: capitonné - non smontabile - cannot be disassembled

TUYO®

2013

base 30 - 120x215 (materasso - mattress 100x200)
plain - quilt - stripe - diamond - capitonné

piani ortopedici - *orthopaedic bases*
1x 99x200 / 1x 38°98x78°74

rete élite - *élite slatted base*
1x 97x200 / 1x 38°19x78°74

reti élite MM - *single élite slatted bases MM*
1x 99x200 / 1x 38°98x78°74

rete élite ME - *single élite slatted base ME*
1x 99x200 / 1x 38°98x78°74

storage box compreso di rete élite - *storage with élite slatted base*

base 30 - 180x215 (materasso - mattress 160x200)
plain - quilt - stripe - diamond - capitonné

piani ortopedici - *orthopaedic bases*
2x 79x200 / 2x 31°10x78°74 (coppia - pair)

rete élite - *élite slatted base*
1x 61°81x78°74

reti élite sdoppiate - *single élite slatted bases*
2x 31°10x78°74 pair

reti élite MM - *single élite slatted bases MM*
2x 79x200 / 2x 31°10x78°74 (coppia - pair)

rete élite ME - *single élite slatted base ME*
2x 31°10x78°74 pair

storage box compreso di rete élite - *storage with élite slatted base*

base 30 - 160x215 (materasso - mattress 140x200)
plain - quilt - stripe - diamond - capitonné

rete élite - *élite slatted base*
1x 137x200 / 1x 53°94x78°74

base 30 - 200x215 (materasso - mattress 180x200)
plain - quilt - stripe - diamond - capitonné

piani ortopedici - *orthopaedic bases*
2x 89x200 / 2x 35°04x78°74 (coppia - pair)

rete élite - *élite slatted base*
1x 177x200 / 1x 69°69x78°74

reti élite sdoppiate - *single élite slatted bases*
2x 89x200 / 2x 35°04x78°74 (coppia - pair)

reti élite MM - *single élite slatted bases MM*
2x 89x200 / 2x 35°04x78°74 (coppia - pair)

rete élite ME - *single élite slatted base ME*
2x 89x200 / 2x 35°04x78°74 (coppia - pair)

storage box compreso di rete élite - *storage with élite slatted base*

base 30 - 220x215 (materasso - mattress 200x200)
plain - quilt - stripe - diamond - capitonné

piani ortopedici - *orthopaedic bases*
2x 99x200 / 2x 38°98x78°74 (coppia - pair)

rete élite - *élite slatted base*
1x 197x200 / 1x 77°56x78°74

reti élite sdoppiate - *single élite slatted bases*
2x 99x200 / 2x 38°98x78°74 (coppia - pair)

reti élite MM - *single élite slatted bases MM*
2x 99x200 / 2x 38°98x78°74 (coppia - pair)

rete élite ME - *single élite slatted base ME*
2x 99x200 / 2x 38°98x78°74 (coppia - pair)

storage box compreso di rete élite - *storage with élite slatted base*

TUYO® - US

2013

base 30 - twin - 120x205 / 48"x81" (materasso - mattress 100x190)
plain - quilt - stripe - diamond - capitonné

rete élite (prezzo su richiesta) - *slatted base (price on request)*

base 30 - queen - 173x218 / 68"x86" (materasso - mattress 153x203)
plain - quilt - stripe - diamond - capitonné

rete élite - *élite slatted base*
1x 150x202 / 1x 59"x80"

storage box compreso di rete élite - *storage with élite slatted base*

base 30 - ca king - 203x228 / 80"x90" (materasso - mattress 183x213)
plain - quilt - stripe - diamond - capitonné

rete élite (prezzo su richiesta) - *slatted base (price on request)*

base 30 - king - 213x218 / 84"x86" (materasso - mattress 193x203)
plain - quilt - stripe - diamond - capitonné

rete élite - *élite slatted base*
1x 190x202 / 1x 75"x80"

storage box compreso di rete élite - *storage with élite slatted base*

MERIDIANI



spring base

- base letto singola imbottita h.36
- rivestimento sfoderabile (intero per configurazione letti matrimoniali) in tessuto (lavabile solo a secco) o pelle
- struttura in legno - imbottitura con molle biconiche - feltri di isolamento - poliuretano indeformabile e fibra poliestere
- giunzioni in metallo per le versioni matrimoniali
- piedini in legno tinto black

- single padded bed base h.36 with removable cover
- removable cover (single for double beds) in fabric (dry cleaning only) or leather
- wooden frame - padding with bi-conic springs - insulating felts non-deformable polyurethane and polyester fibre
- metal brackets for double beds
- wooden feet, black stained

- gepolsterter Einzel-Bettrahmen h.36
- abziehbarer Bezug aus Stoff oder Leder (mit durchgehender Housse beim Doppelbett)
- Nur Trockenreinigung
- Holzgestell, Polsterung mit bikonischen Sprungfedern - Isolierfilzen - unverformbaren PU-Schäumen und Polyesterfaser
- Metallklammer für Verbindung beim Doppelbett
- Holzfüße schwarz gebeizt

- base de lit simple rembourrée h.36
- revêtement déhoussable (entier pour versions doubles en tissu - nettoyage à sec uniquement) ou cuir
- structure en bois - rembourrage avec ressorts biconiques - feutres isolantes - polyuréthane indéformable et fibre polyester
- système de fixation en métal pour versions doubles
- pieds en bois teintés black

- base cama individual acolchada h.36
- revestimiento desfundable (entero para camas matrimoniales) en tela (sólo limpieza en seco) o piel
- estructura de madera, relleno con muelles biconicos - fieltros aislantes - poliuretano indeformable y fibra poliéster
- abrazaderas en metal para camas matrimoniales
- patas de madera teñidos black

misure speciali:
lunghezza letto max 220 cm - larghezza min 100 max 200 cm (vano interno)

special sizes:
bed max length 220 cm - minimum width 100 cm, max 200 cm (inner size)

Sondermaß:
länge lit max 220 cm - breite minimum 100 cm, max 200 cm (dimension intérieure)

mésures spéciales:
longueur lit max 220 cm - largeur minimum 100 cm, max 200 cm (dimension intérieure)

medidas especiales:
largo cama max 220 cm - ancho min 100 max 200 cm (espacio interior)
largo somier elite fija max 210 cm

CA KING size available on request
for pricing get in touch with our sales office

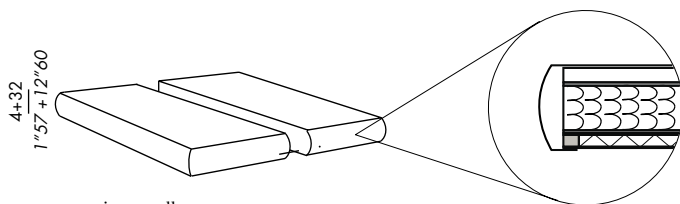

sommier a molle
spring bases

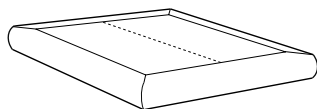

finitura / finish: plain

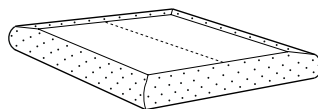

finitura / finish: quilt

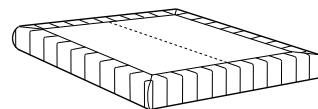

finitura / finish: stripe

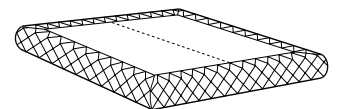

finitura / finish: diamond

TUYO®

2013

spring base - 110x210 (materasso - *mattress* 100x200)
plain - quilt - stripe - diamond

spring base - 170x210 (base 2x85) (materasso - *mattress* 160x200)
plain - quilt - stripe - diamond

spring base - 190x210 (base 2x95) (materasso - *mattress* 180x200)
plain - quilt - stripe - diamond

spring base - 210x210 (base 2x105) (materasso - *mattress* 200x200)
plain - quilt - stripe - diamond

TUYO® - US

2013

spring base - queen - 163x213 / 64"x84" (materasso - *mattress* 153x203)
plain - quilt - stripe - diamond

spring base - king - 203x213 / 80"x84" (materasso - *mattress* 193x203)
plain - quilt - stripe - diamond



double spring base

- base letto singola imbottita h.46
- rivestimento sfoderabile (intero per configurazione letti matrimoniali) in tessuto (lavabile solo a secco) o pelle
- struttura in legno - imbottitura con molle biconiche - feltri di isolamento - molle insacchettate - poliuretano indeformabile e fibra poliestere
- giunzioni in metallo per le versioni matrimoniali
- piedini in legno tinto black

- single padded bed base h.46 with removable cover
- removable cover (single for double beds) in fabric (dry cleaning only) or leather
- wooden frame, padding with bi-conic springs - insulating felts - encased springs - non-deformable polyurethane and polyester fibre
- metal brackets for double beds
- wooden feet, black stained

- gepolsterter Einzel-Bettrahmen h.46
- Abziehbarer Bezug aus Stoff oder Leder (mit durchgehender Housse beim Doppelbett)
- Nur Trockenreinigung
- Holzgestell - Polsterung mit bikonischen Sprungfedern - Isolierfilzen - Taschenfederkern - PU-Schäumen und Polyesterfaser
- Metallklammer für Verbindung beim Doppelbett
- Holzfüße schwarz gebeizt

- base de lit simple rembourrée h.46
- revêtement déhoussable (entier pour versions doubles en tissu - nettoyage à sec uniquement) ou cuir
- structure en bois - rembourrage avec ressorts biconiques - feutres isolantes - ressorts ensachés - polyuréthane indéformable et fibre polyester
- jonctions en métal pour versions doubles
- pieds en bois teintés black

- base cama individual acolchada h.46
- revestimiento desfundable (entero para camas matrimoniales) en tela (sólo limpieza en seco) o piel
- estructura de madera - relleno con muelles biconicos - fieltros aislantes - muelles ensacados - poliuretano indeformable y fibra poliéster
- abrazaderas en metal para camas matrimoniales
- patas de madera teñidos black

si consiglia - come materasso - il topper plus (schiuma viscoelastica e fibra anallergica)

topper plus (made of viscoelastic foam and anallergic fibre) is suggested instead of a traditional mattress

Statt der Standardmatratze ist der Topper Plus (aus viskoelastischem Schaum und Polyesterfaser) empfehlt

nous conseillons comme matelas le topper plus (mousse viscoélastique et fibre anallergique)

como colchón aconsejamos el topper plus (espuma viscoelástica y fibra no alérgica)

misure speciali:
lunghezza letto max 220 cm - larghezza min 100 max 200 cm (vano interno)

special sizes:
bed max length 220 cm - minimum width 100 cm, max 200 cm (inner size)

Sondermaß:
Länge des Bettes max. 220 cm . Breite min. 100 max. 200 cm (Innenmaß)

mésures spéciales:
longueur lit max 220 cm - largeur minimum 100 cm, max 200 cm (dimension intérieure)

medidas especiales:
largo cama max 220 cm - ancho min 100 max 200 cm (espacio interior)

CA KING size available on request for pricing get in touch with our sales office

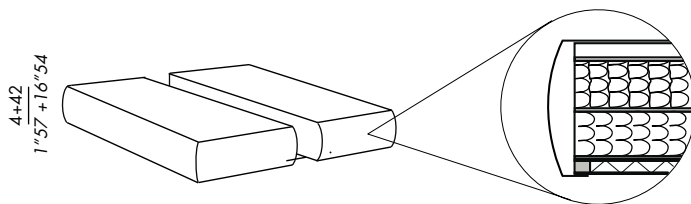

sommier a molle
spring bases

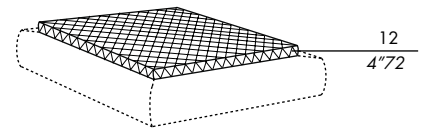

topper plus

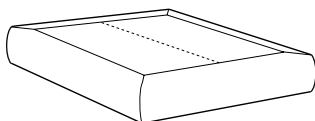

finitura / finish: plain

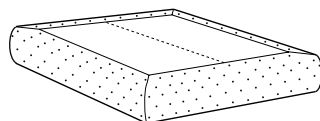

finitura / finish: quilt

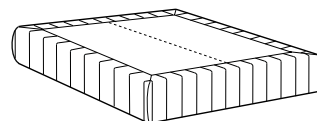

finitura / finish: stripe

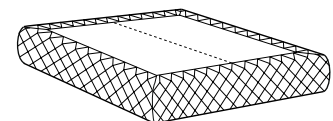

finitura / finish: diamond

TUYO®

2013

double spring base - 110x210 (materasso - mattress 100x200)

plain - quilt - stripe - diamond

topper plus

100x200 / 39"37x78"74

double spring base - 170x210 (base 2x85) (materasso - mattress 160x200)

plain - quilt - stripe - diamond

topper plus

160x200 / 62"99x78"74

double spring base - 190x210 (base 2x95) (materasso - mattress 180x200)

plain - quilt - stripe - diamond

topper plus

180x200 / 70"87x78"74

double spring base - 210x210 (base 2x105) (materasso - mattress 200x200)

plain - quilt - stripe - diamond

topper plus

200x200 / 78"74x78"74

TUYO® - US

2013

double spring base - queen - 163x213 / 64"x84" (materasso - mattress 153x203)

plain - quilt - stripe - diamond

topper plus

153x203 / 60"x80"

double spring base - king - 203x213 / 80"x84" (materasso - mattress 193x203)

plain - quilt - stripe - diamond

topper plus

193x203 / 76"x80"