

design by Novamobili Studio

INFORMAZIONI TECNICHE /

TECHNICAL INFORMATION

Il sistema modulare BOX 18 è costituito da una vasta gamma di elementi che interagiscono perfettamente tra di loro, aventi come caratteristica comune la scocca sp. 18 mm.

CONTENITORI BASE: Disponibili nelle versioni con apertura standard (senza gola), sono proposti nelle varianti a terra con livellatori, in appoggio o sospesi. La versione in appoggio è da utilizzare per contenitori sopra panca o sostenuti da piedi H. 16,9 cm o H. 8 cm. /

The BOX 18 modular system comprises an extensive range of units that interact perfectly with each other as they share a common feature: their 18mm-thick carcass.

BASE STORAGE UNITS: With standard opening (no profiles), they come in different versions - floorstanding with levellers, sit-on-top or wall mounted. *The sit-on-top version is to be used for storage units designed to sit on a bench or be supported by 16,9cm- or 8cm-high feet.*

CONTENITORE BASE / BASE STORAGE UNIT

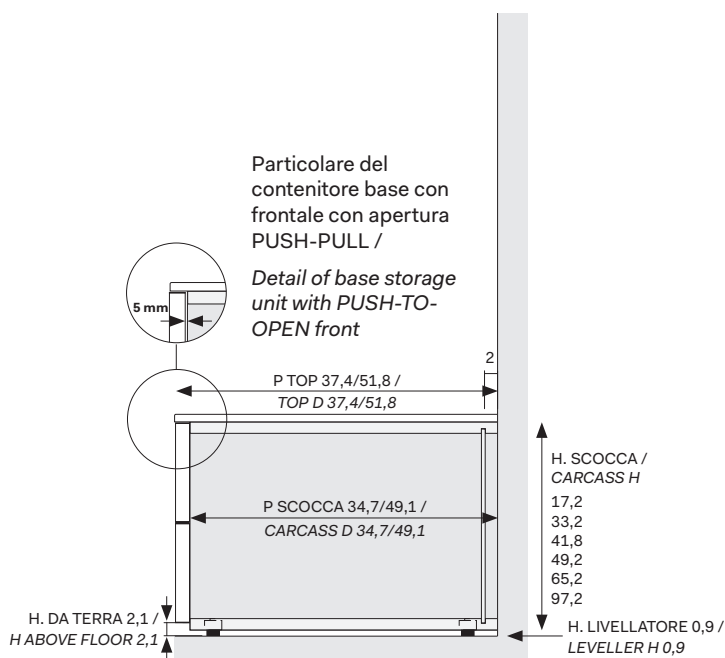

CONTENITORE BASE SOSPESO / WALL-MOUNTED BASE STORAGE UNIT

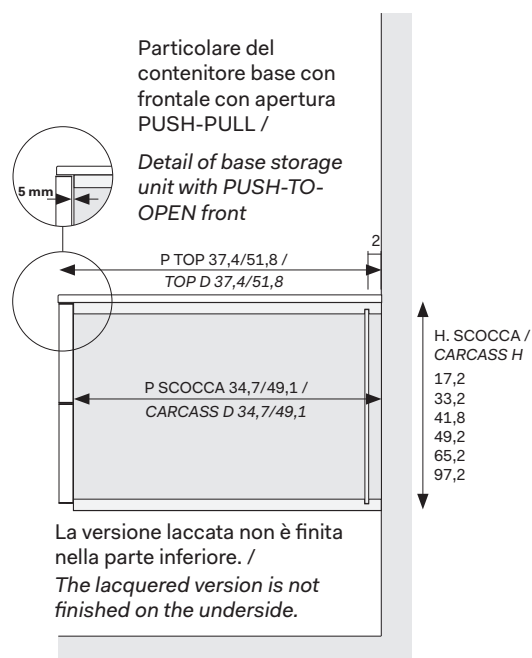

PORTATA MASSIMA BASI SOSPESSE A MURO / LOAD CAPACITY OF WALL-MOUNTED BASE UNITS

L. W	H. H	18,1	34,1	42,7	50,1	66,1	98,1
45		kg 15	kg 20	kg 20	kg 20	kg 25	kg 30
60		kg 15	kg 20	kg 20	kg 20	kg 25	kg 30
75		kg 15	kg 20	kg 20	kg 20	kg 25	kg 30
90		kg 15	kg 20	kg 20	kg 20	kg 25	kg 30
120		kg 15	kg 20	kg 20	kg 20	kg 25	kg 30
135		kg 20	kg 25	kg 25	--	--	--
150		kg 20	kg 30	kg 30	--	--	--

design by Novamobili Studio

CONTENITORI BASE: MODULARITÀ /
BASE STORAGE UNITS: MODULE SIZE

LARGHEZZE BASI P. 37,4 /
WIDTHS OF BASE UNITS D 37,4

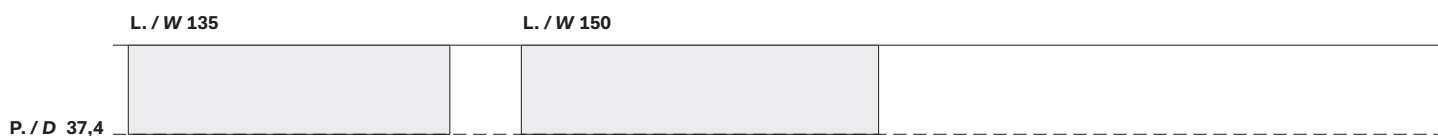
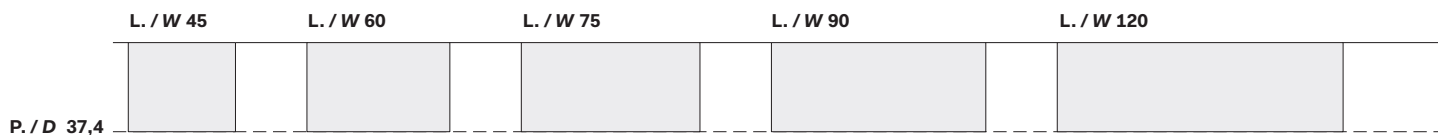

LARGHEZZE BASI P. / 51,8 /
WIDTHS OF BASE UNITS D 51,8

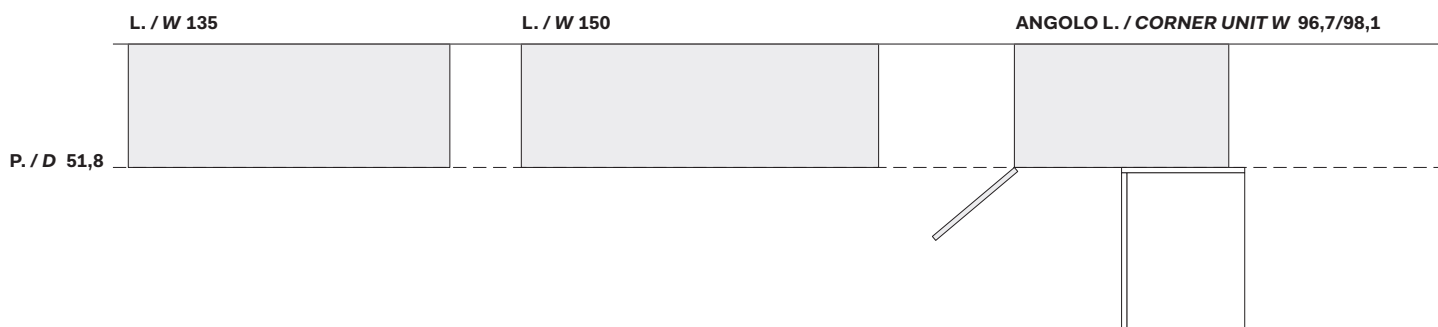
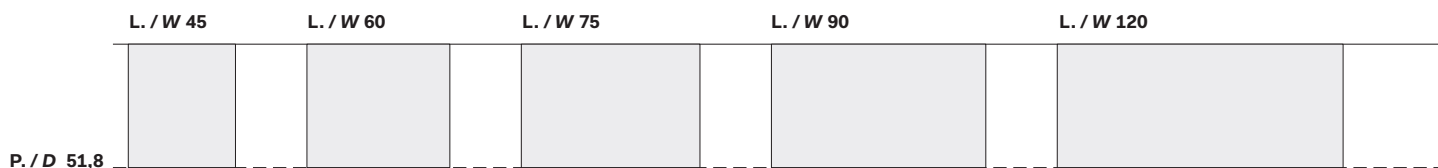

design by Novamobili Studio

ALTEZZE (Escluso top) /
HEIGHTS (Top NOT included)

In altezza va sempre
aggiunto il top disponibile
negli sp. 0,8/1,2/3/5 cm. /
Always add the top -
available in 0,8/1,2/3/5
cm-thick options - to
calculate the total height.

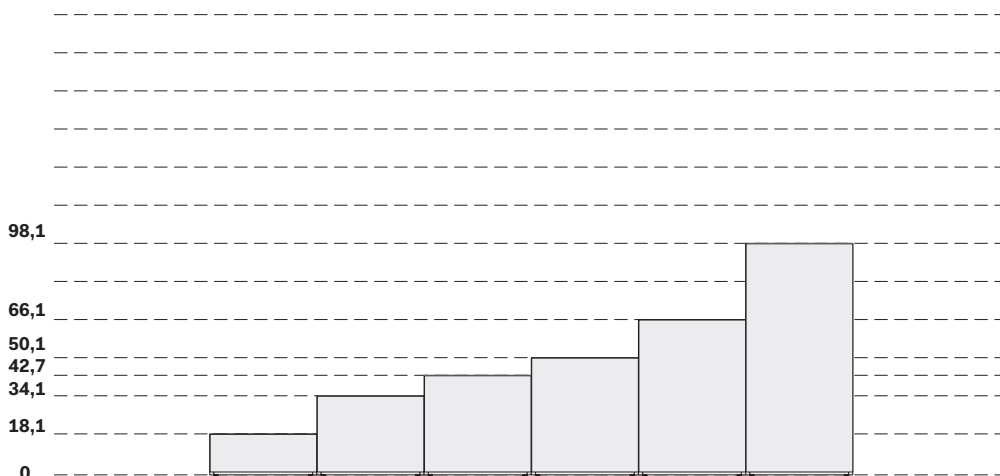

LARGHEZZE
PER ALTEZZA /
WIDTHS BASED
ON HEIGHT

Largh. / Width	H 18,1	H 34,1	H 42,7	H 50,1	H 66,1	H 98,1
45	X	X	X	X	X	X
60	X	X	X	X	X	X
75	X	X	X	X	X	X
90	X	X	X	X	X	X
120	X	X	X	X	X	X
135	X	X	X	--	--	--
150	X	X	X	--	--	--

PROFONDITÀ /
DEPTHS

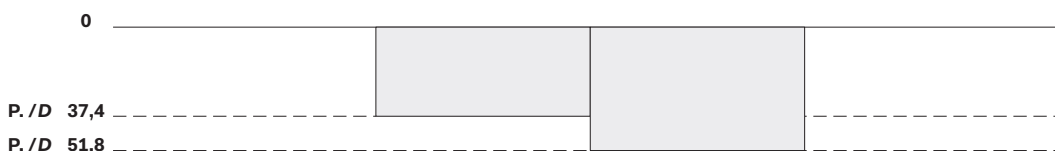

SCHEMA APERTURE CONTENITORI BASE /
ILLUSTRATION OF BASE STORAGE UNIT OPENING SYSTEMS

BATTENTE /
HINGED



CASSETTONE /
OVERSIZED
DRAWER



RIBALTA /
PULL-DOWN
DOOR

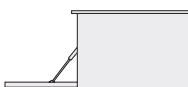

RIBALTA FILO /
FILO PULL-DOWN
DOOR

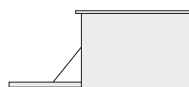

CASSETTI /
DRAWERS



PORTACARTELLE /
HANGING FOLDER
SYSTEM

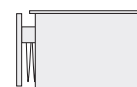

design by Novamobili Studio

INFORMAZIONI TECNICHE /

TECHNICAL INFORMATION

Il sistema modulare BOX 18 è costituito da una vasta gamma di elementi che interagiscono perfettamente tra di loro, aventi come caratteristica comune la scocca sp. 18 mm.

CONTENITORI BASE GOLA: Disponibili nelle versioni con gola sono proposti nelle varianti a terra con livellatori, in appoggio o sospesi.
La versione in appoggio è da utilizzare per contenitori sopra panca o sostenuti da piedi H.16,9 cm o H. 8 cm. /

The BOX 18 modular system comprises an extensive range of units that interact perfectly with each other as they share a common feature: their 18mm-thick carcass.

GOLA BASE STORAGE UNITS: *With the option of profiles they come in different versions - floorstanding with levellers, sit-on-top or wall mounted. The sit-on-top version is to be used for storage units designed to sit on a bench or be supported by 16,9cm- or 8cm-high feet.*

CONTENITORE BASE GOLA / GOLA BASE STORAGE UNIT

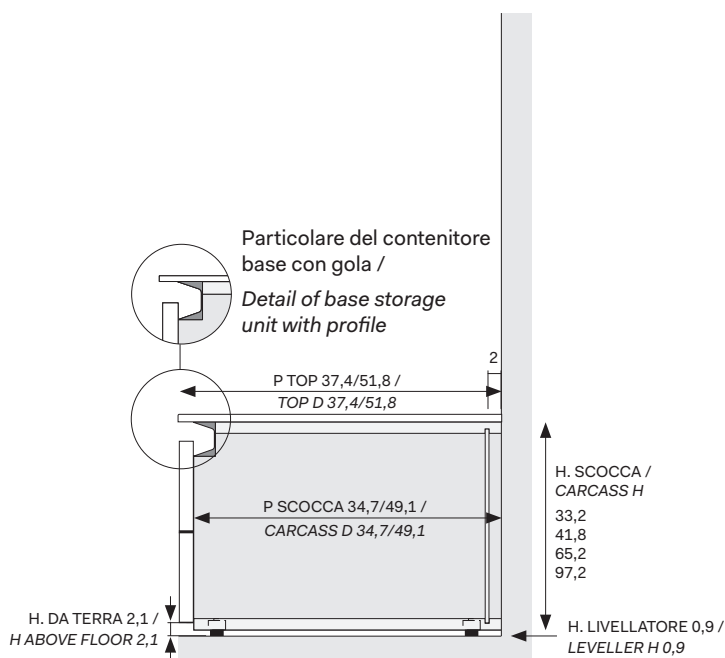

CONTENITORE BASE GOLA SOSPESO / WALL-MOUNTED GOLA BASE STORAGE UNIT

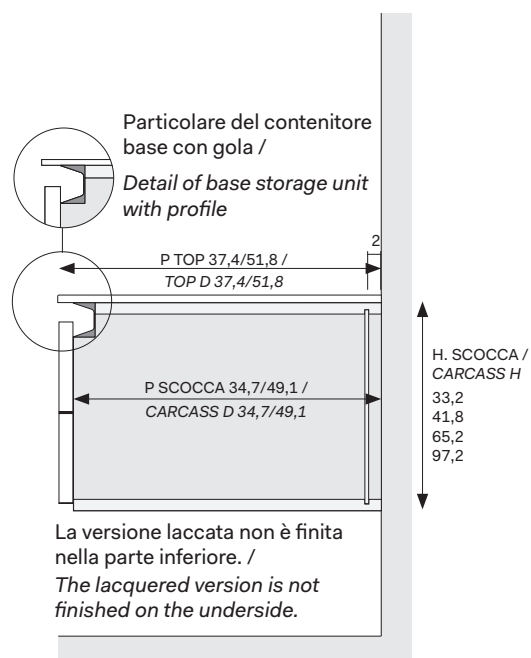

PORTATA MASSIMA BASI GOLA SOSPESSE A MURO /

LOAD CAPACITY OF WALL-MOUNTED GOLA BASE UNITS

L. W	H. H	34,1	42,7	66,1	98,1
45		kg 20	kg 20	kg 25	kg 30
60		kg 20	kg 20	kg 25	kg 30
75		kg 20	kg 20	kg 25	kg 30
90		kg 20	kg 20	kg 25	kg 30
120		kg 20	kg 20	kg 25	kg 30
135		kg 25	kg 25	--	--
150		kg 30	kg 30	--	--

design by Novamobili Studio

CONTENITORI BASE GOLA: MODULARITÀ /
GOLA BASE STORAGE UNITS: MODULE SIZE

LARGHEZZE BASI GOLA P. 37,4 /
WIDTHS OF GOLA BASE UNITS D 37,4

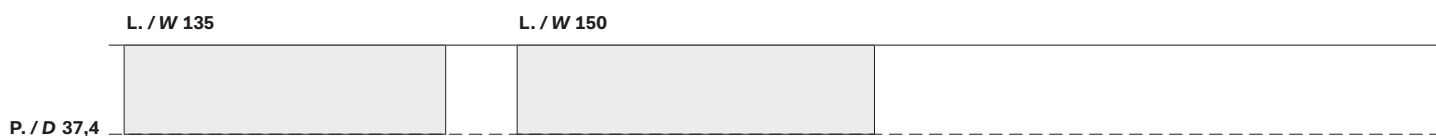
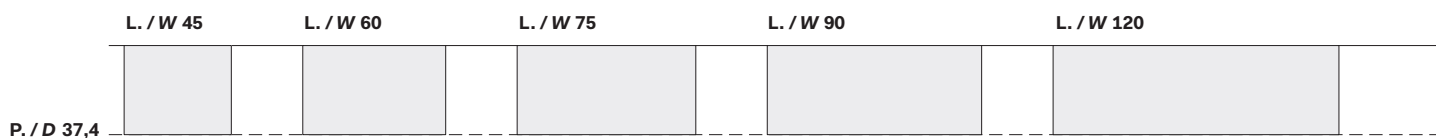

LARGHEZZE BASI GOLA P. 51,8 /
WIDTHS OF GOLA BASE UNITS D 51,8

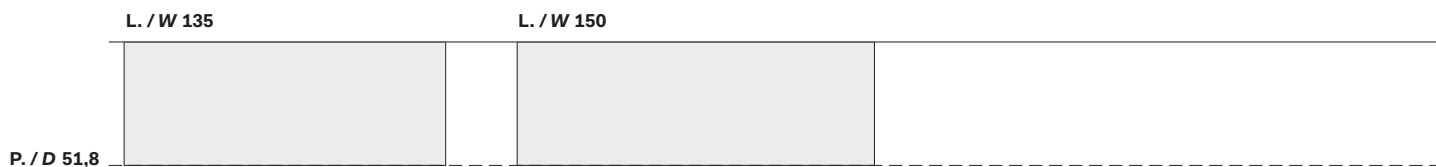
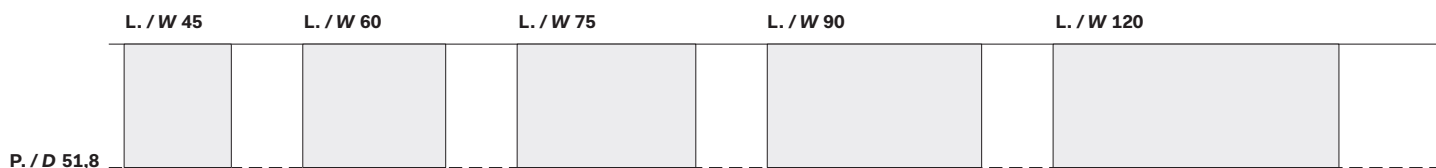

design by Novamobili Studio

ALTEZZE (Escluso top) /
HEIGHTS (Top NOT included)

In altezza va sempre aggiunto il top disponibile negli sp. 0,8/1,2/3/5 cm. /
Always add the top - available in 0,8/1,2/3/5 cm-thick options - to calculate the total height.

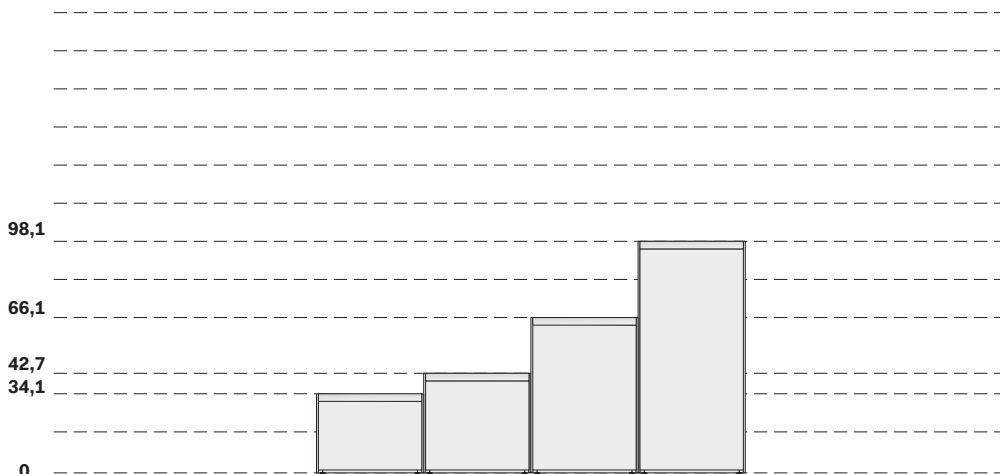

Con livellatori H. 0,9 cm /
With levellers H 0,9 cm

LARGHEZZE
PER ALTEZZA /
WIDTHS BASED
ON HEIGHT

In larghezza vanno sempre aggiunti ai lati della composizione due fianchi di finitura sp. 0,8 cm. /

Always add the two 0,8cm-thick finishing side panels on the ends of the composition to calculate the total width.

Largh. / Width	H 34,1	H 42,7	H 66,1	H 98,1
45	X	X	X	X
60	X	X	X	X
75	X	X	X	X
90	X	X	X	X
120	X	X	X	X
135	X	X	--	--
150	X	X	--	--

PROFONDITÀ /
DEPTHS



SCHEMA APERTURE CONTENITORI BASE /
ILLUSTRATION OF BASE STORAGE UNIT OPENING SYSTEMS

BATTENTE /
HINGED

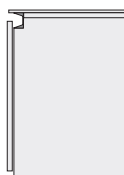

CASSETTONE /
OVERSIZED
DRAWER

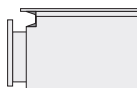

RIBALTA /
PULL-DOWN
DOOR

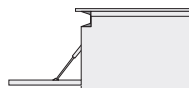

RIBALTA FILO /
FILO PULL-DOWN
DOOR

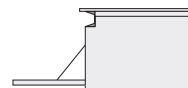

design by Novamobili Studio

CONTENITORI BASE/CONTENITORI BASE GOLA: ESEMPIO DI UTILIZZO TOP E VASSOI /
 BASE STORAGE UNITS/GOLA BASE STORAGE UNITS: TOPS AND TRAYS SAMPLE USE

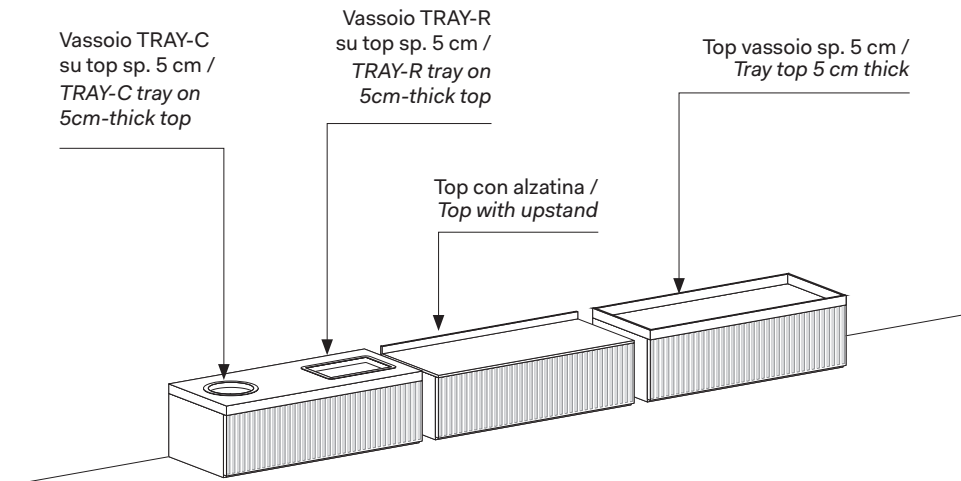

VASSOI TRAY AD INCASSO /
 RECESSED "TRAY" TRAYS

Posizionabili su tutti i top, escluso su top vassoio. /
 Can be placed on all tops, except tray tops.

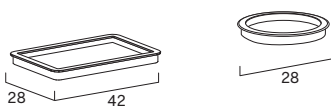

TRAY-R L. 42 P. 28 cm /
 TRAY-R W 42 D 28 cm

3 posizionamenti possibili /
 3 positioning options

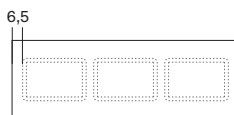

TRAY-C Ø 28 cm /
 TRAY-C Ø 28 cm

3 posizionamenti possibili /
 3 positioning options



Vista in sezione dei vassoi TRAY /
 Cross-section of TRAY trays

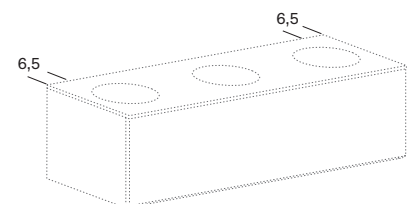
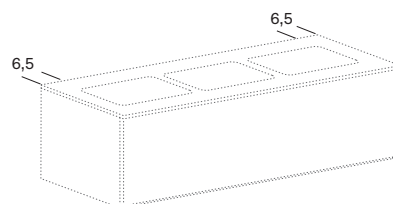
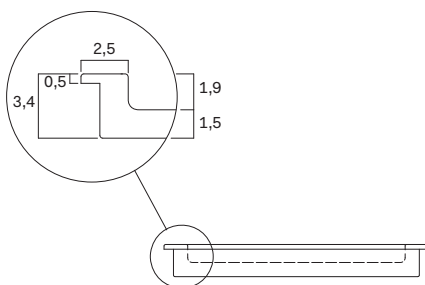

design by Novamobili Studio

INFORMAZIONI TECNICHE /

TECHNICAL INFORMATION

Il sistema modulare BOX 18 è costituito da una vasta gamma di elementi che interagiscono perfettamente tra di loro, aventi come caratteristica comune la scocca sp. 18 mm.

CONTENITORI PENSILE: Proposti nelle varianti con ripiani vetro o ripiani legno. /

The BOX 18 modular system comprises an extensive range of units that interact perfectly with each other as they share a common feature: their 18mm-thick carcass.

WALL UNITS: *They come with the option of glass shelves or wood shelves.*

CONTENITORE PENSILE /

WALL UNIT

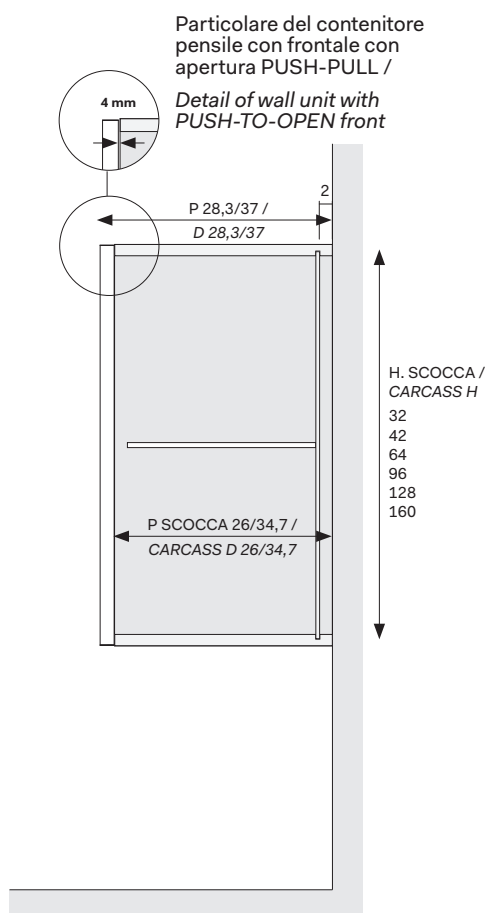

PORTATA MASSIMA PENSILI A MURO /

LOAD CAPACITY OF WALL UNITS

L. W	H. H	32	42	64	96	128	160
30	--	kg 15	kg 15	kg 15	kg 15	kg 15	kg 15
45	kg 15	kg 15	kg 15	kg 15	kg 15	kg 15	kg 15
60	kg 15	kg 15	kg 15	kg 15	kg 15	kg 15	kg 15
75	kg 15	kg 15	--	--	--	--	--
90	kg 15	kg 15	--	--	--	--	--
120	kg 25	kg 25	--	--	--	--	--
135	kg 25	kg 25	--	--	--	--	--
150	kg 30	kg 30	--	--	--	--	--

design by Novamobili Studio

CONTENITORI PENSILI: MODULARITÀ /

WALL UNITS: MODULE SIZE

LARGHEZZE PENSILI P. 28,3 /

WIDTHS OF WALL UNITS D 28,3

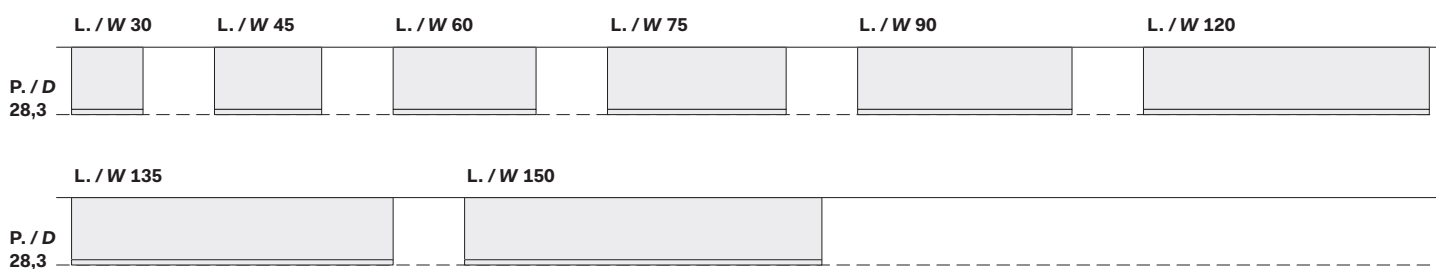

LARGHEZZE PENSILI P. 37 /

WIDTHS OF WALL UNITS D 37

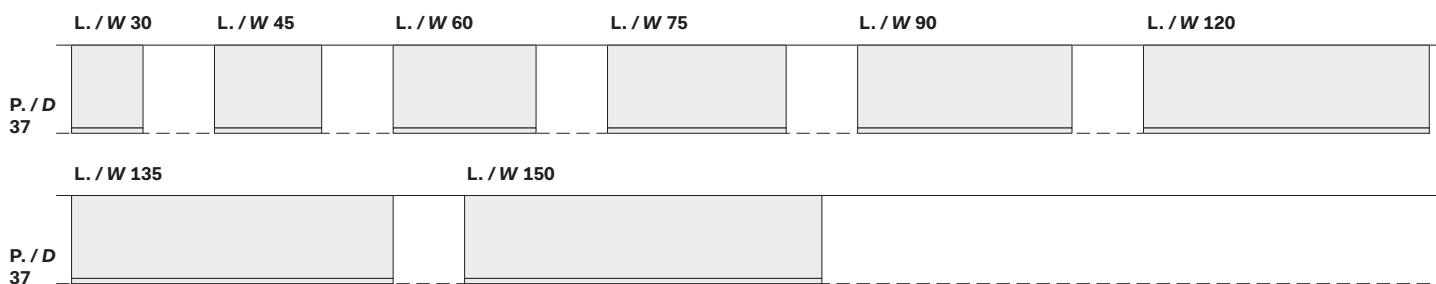

design by Novamobili Studio

ALTEZZE /
HEIGHTS

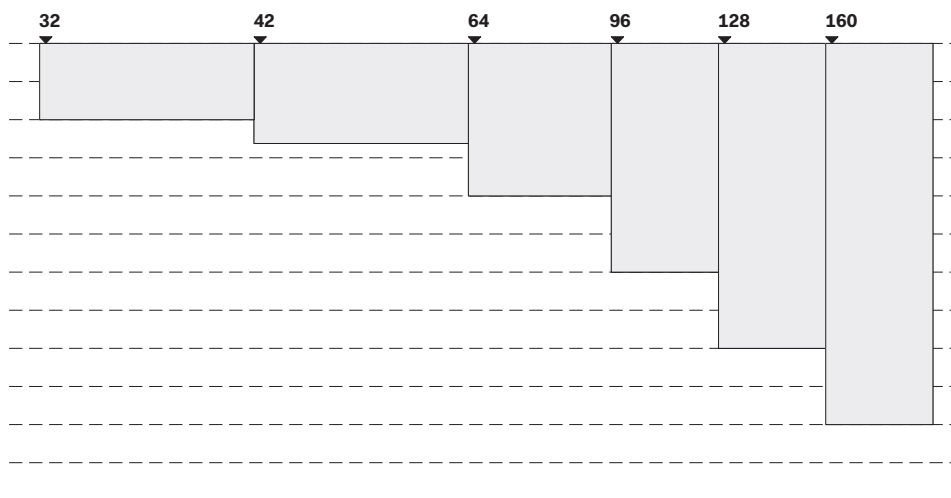

LARGHEZZE
PER ALTEZZA /
WIDTHS BASED
ON HEIGHT

Largh. / Width	H 32	H 42	H 64	H 96	H 128	H 160
30	--	X	X	X	X	X
45	X	X	X	X	X	X
60	X	X	X	X	X	X
75	X	X	--	--	--	--
90	X	X	--	--	--	--
120	X	X	--	--	--	--
135	X	X	--	--	--	--
150	X	X	--	--	--	--

PROFONDITÀ /
DEPTH

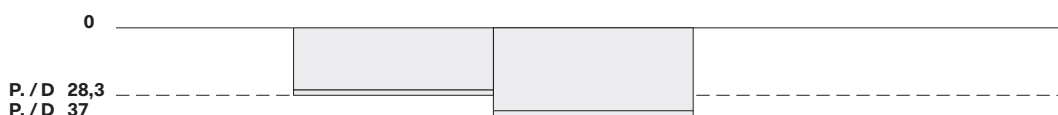

SCHEMA APERTURE CONTENITORI PENSILE /
ILLUSTRATION OF WALL UNIT OPENING SYSTEMS

RIALZA /
LIFT-UP

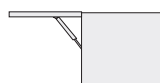

RIBALTA /
PULL-DOWN
DOOR

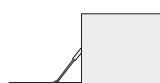

RIBALTA FILO /
FILO PULL-DOWN
DOOR

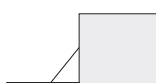

BATTENTE /
HINGED



CASSETTI /
DRAWERS

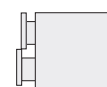

design by Novamobili Studio

CONTENITORI PENSILI CON ANTA SPORGENTE: MODULARITÀ /
WALL UNITS WITH PROTRUDING DOOR: MODULE SIZE

ALTEZZE /
HEIGHTS

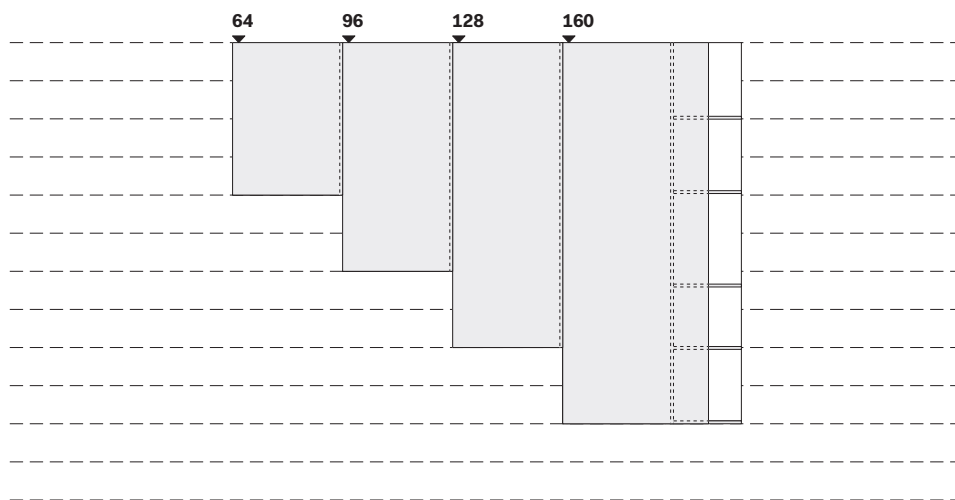

LARGHEZZE
PER ALTEZZA /
WIDTHS BASED
ON HEIGHT

Largh. / Width	H 64	H 96	H 128	H 160
31,2	X	X	X	X
46,2	X	X	X	X
61,2	X	X	X	X
60	X	X	X	X
75	X	X	X	X

PROFONDITÀ /
DEPTH

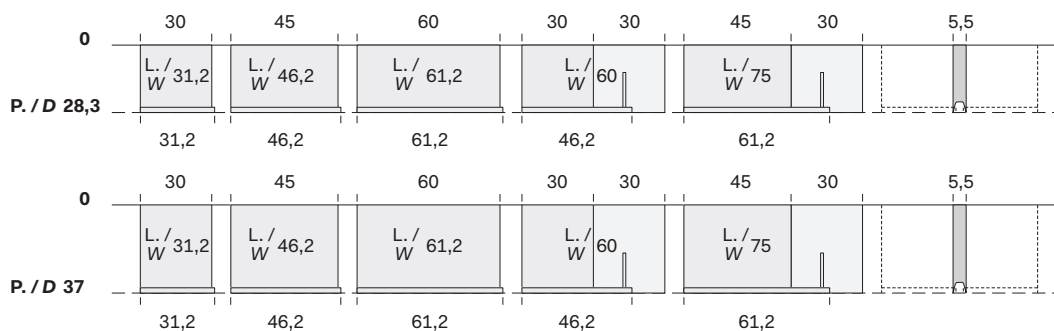

SCHEMA APERTURE CONTENITORI PENSILI CON ANTA SPORGENTE /
ILLUSTRATION OF OPENING SYSTEMS FOR WALL UNITS WITH PROTRUDING DOOR

BATTENTE /
HINGED



apertura verso il centro /
opening inwards

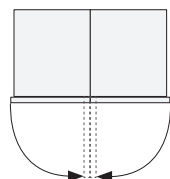

pensili accostati /
side-by-side wall units

apertura verso i lati /
opening outwards

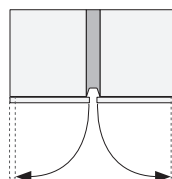

pensili accostati con elemento di
unione con gola verticale /
side-by-side wall units joined with
connecting piece with vertical groove

apertura verso un lato (dx o sx) /
door swing to side (RH or LH)

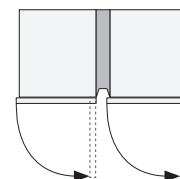

Casellari a giorno per BOX 18 / Open wall unit for BOX 18

NOVAMOBILI

design by Novamobili Studio

ESEMPIO DI UTILIZZO CASELLARI A GIORNO /
OPEN WALL UNIT SAMPLE USE

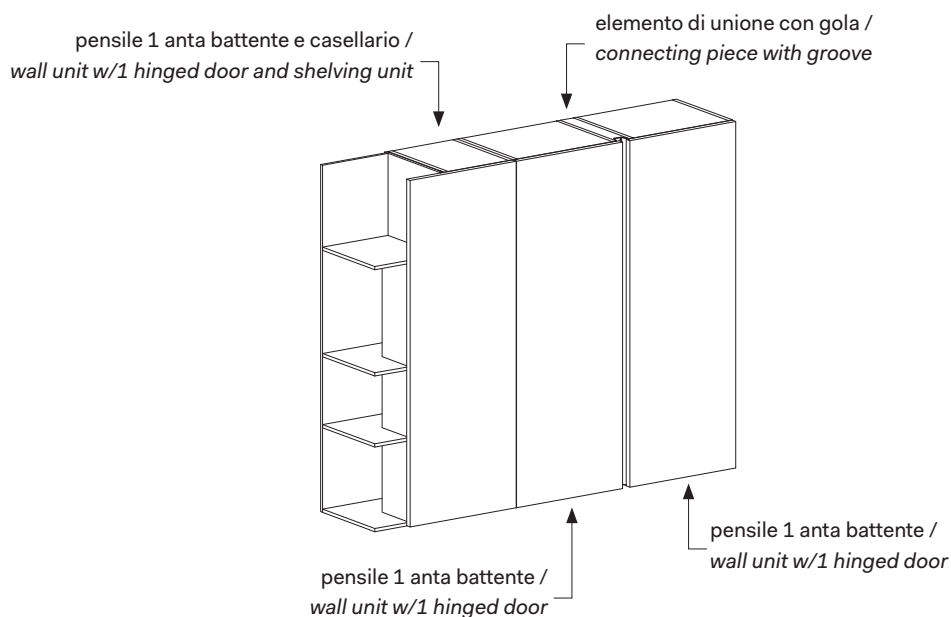

Le ante dei pensili sporgono lateralmente dalla scocca di 1,2 cm per consentirne l'apertura.
Nel caso di accostamento di due pensili sono consigliate due tipi di aperture: /

*The wall unit doors stick out from the side of the carcass by 1,2 cm so they have room to open.
In the event two wall units are set side by side, there are two recommended opening options:*

apertura verso il centro / opening inwards

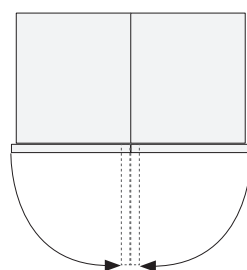

pensili accostati / side-by-side wall units

apertura verso i lati / opening outwards

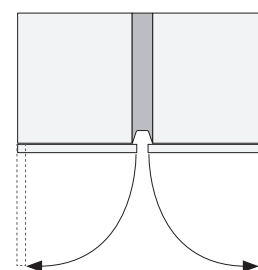

pensili accostati con elemento di unione con gola verticale / side-by-side wall units joined with connecting piece with vertical groove

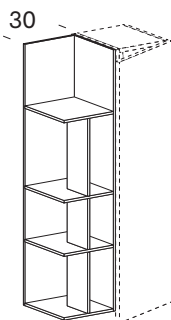

misure cm / dimensions cm

L. / W	H. / H	P. / D
30	64	28,3
	96	37
	128	
	160	

Le informazioni contenute nelle presenti schede tecniche sono indicative. Eventuali differenze con il listino in vigore non costituiscono motivo di contestazione.
The information given in this technical sheet are indicative. Any discrepancies with the price list currently in force cannot be cause for complaint.