



Cut, 910/PL
poltrona lounge \ *lounge armchair*

Informazioni tecniche \ *Technical information*

Descrizione tecnica \ *Technical description*



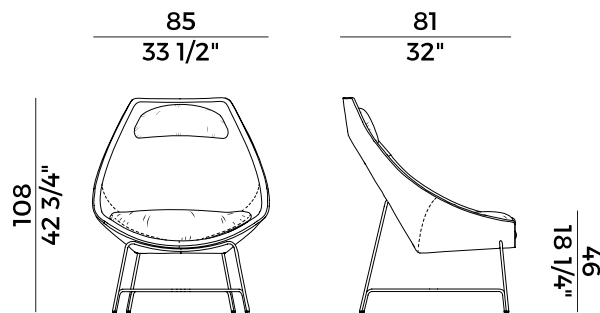

Poltrona lounge in versione fissa con base a quattro gambe in alluminio verniciato nero goffrato e imbottita in poliuretano espanso ignifugo. Rivestimenti di collezione.

Lounge armchair with four legs base in embossed black painted aluminum and padded in fire retardant polyurethane foam. Covers as per collection.

Dimensioni \ *Dimensions*



Consumi stoffe \ *Fabric and leather requirements*

FABRIC / LEATHER REQUIREMENTS				FABRIC / LEATHER REQUIREMENTS			
		x1	x2			x1	x2
	H 140	ml 3,80	ml 7,60		H 140	yd 4,20	yd 8,35
	LEATHER	m ² 8,50			LEATHER	ft ² 92	

Finiture \ *Finishes*

Finiture struttura \

Frame finishes

Alluminio \ *Aluminium*



Alluminio Nero Goffrato \
Embossed Black Aluminium

Rivestimenti \

Coverings

Tessuto, ecopelle, pelle \ *Fabric, eco-leather, leather*

Collezione Cut \
 Cut collection

Poltrona lounge in versione girevole o fissa con poggiatesta a base centrale in alluminio verniciato nero goffato. Imbottita in poliuretano espanso ignifugo. Rivestimenti di collezione.

Lounge armchair available in the swivel or fixed versions with footrest characterized by the central base in embossed black painted aluminum and padded in fire retardant polyurethane foam. Coverings as per collection.

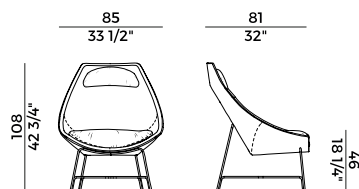

910/PL
lounge girevole \ swivel lounge armchair

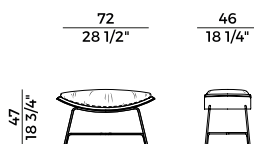

910/PP
poggiapiedi \ footrest

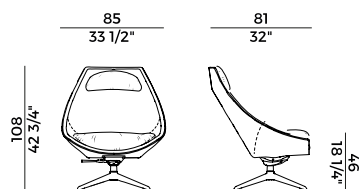

910/PLG
lounge girevole \ swivel lounge armchair

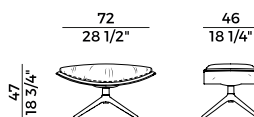

910/PPG
poggiapiedi \ footrest



Cut, 910/PP
poggiapiedi \ *footrest*

Informazioni tecniche \ *Technical information*

Descrizione tecnica \ *Technical description*



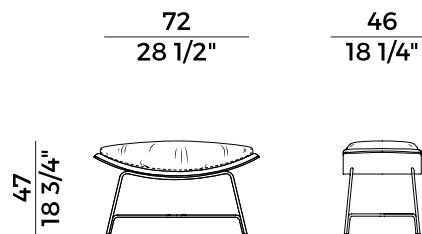

Poggiapiedi in versione fissa con base a quattro gambe in alluminio verniciato nero goffrato e imbottita in poliuretano espanso ignifugo. Rivestimenti di collezione.

Footrest with four legs base in embossed black painted aluminum and padded in fire retardant polyurethane foam. Covers as per collection.

Dimensioni \ *Dimensions*



Consumi stoffe \ *Fabric and leather requirements*

FABRIC / LEATHER REQUIREMENTS				FABRIC / LEATHER REQUIREMENTS			
		x1	x2			x1	x2
	H 140	ml 1,50	ml 3,00		H 140	yd 1,65	yd 3,30
	LEATHER	m ² 2,90			LEATHER	ft ² 32	

Finiture \ *Finishes*

Finiture struttura \

Frame finishes

Alluminio \ *Aluminium*



Alluminio Nero Goffrato \
Embossed Black Aluminium

Rivestimenti \

Coverings

Tessuto, ecopelle, pelle \ *Fabric, eco-leather, leather*

Collezione Cut \
 Cut collection

Poltrona lounge in versione girevole o fissa con poggiatesta a base centrale in alluminio verniciato nero goffrato. Imbottita in poliuretano espanso ignifugo. Rivestimenti di collezione.

Lounge armchair available in the swivel or fixed versions with footrest characterized by the central base in embossed black painted aluminum and padded in fire retardant polyurethane foam. Coverings as per collection.

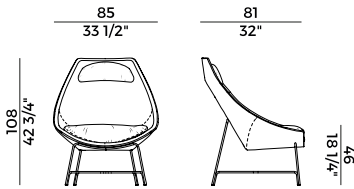

910/PL
lounge girevole \ swivel lounge armchair

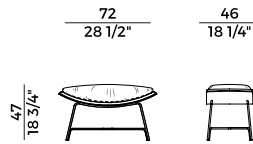

910/PP
poggiatesta \ footrest

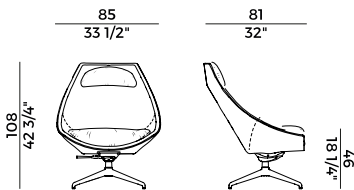

910/PLG
lounge girevole \ swivel lounge armchair

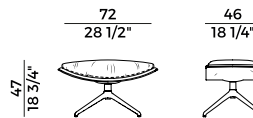

910/PPG
poggiatesta \ footrest