



LORETTA

Design E. Gallina

POLTRONA | ARMCHAIR

2016

Poltrona con struttura in massello di frassino e rivestimento nei tessuti della

Armchair with frame in solid ash and cover in the fabric of the collection.

Sessel mit Gestell aus massiver Esche und Bezug in den Stoffen der Kollektion.

Fauteuil fauteuil avec structure en frêne massif et revêtement dans les tissus de la collection.

Butaca con estructura en fresno macizo y revestimiento en las telas de la colección.

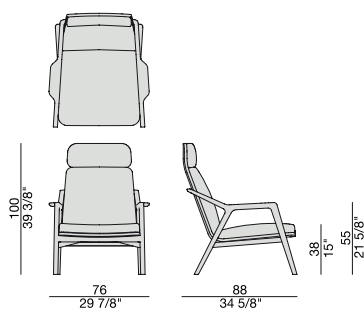

Essenze | Wood



FRASSINONATURALE
Natural Ash

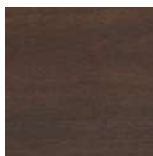

FRASSINO
Ash
tinto/stained moka

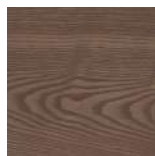

FRASSINO
Ash
tinto/stained canaletta walnut



FRASSINO
Ash
tinto/stained wengé

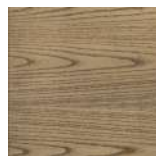

FRASSINO
Ash
tinto/stained canapa

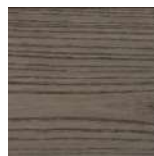

FRASSINO
Ash
tinto/stained caffè

Laccato opaco poro aperto | Matt Lacquered open pore



BIANCO
White
(RAL 9016)



AVORIO
Ivory
(RAL 1013)



ARGILLA
Argilla
(RAL 7006)



PIOMBO
Piombo
(NCS S5005G20Y)

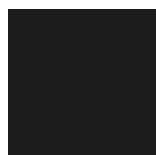

NERO
Black
(RAL 9005)



GRANATA
Granata
(NCS S4050Y90R)



PISTACCHIO
Pistacchio
(PANTONE 5825)

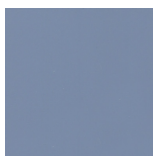

AVIO
Avio
(PANTONE 5415)

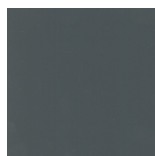

IRON
Iron
(RAL 7011)



CIOCCOLATO
Chocolate
(RAL 8019)

Pelle | Leather

Cat. LUX

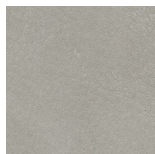

Nabuk

Cat. PLUS



Pelle PLUS

Cat. EXTRA



Pelle EXTRA

Cat. PELLE



Pelle

Rivestimento | Cover

Cat. A

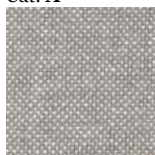

Hallingdal 65



Hound

Cat. B



Rabat



Milord

Cat. C



Armam



Fashion

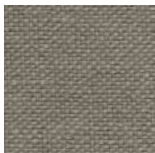

Flax



Ikat



Loom



Madras



Moran

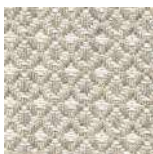

Thalys



Velvet



Wool

Cat. D



Astra



Ecopelle



Range



Tress

Cat. E



Cotone



Dorian



In Bianco/Calico

Cat. COM

Disponibile con tessuto fornito dal cliente.

Available with fabric supplied by the customer.

Verfügbar mit Kundenstoff.

Disponible avec tissu du client.

Disponible con tela suministrada por el cliente.