

design — Wolfgang C.R. Mezger



**Jolly, 751/AI-GAS**  
sgabello \ stool

La famiglia di sedute Jolly si contraddistingue per la scocca rigida ed ergonomica dello schienale, in tessuto o pelle, dalla curvatura tridimensionale, una caratteristica che attraversa tutta la famiglia, passando per le sue diverse declinazioni: poltrona, sgabello con gambe in rovere e con base centrale regolabile in metallo. Questi ultimi sono proposti, inoltre, con schienale esterno rivestito in rovere.

*The Jolly collection is characterized by seating with ergonomic shell of the backrest, made of fabric or leather, with a three-dimensional curvature, which is a feature that runs throughout the whole collection from the armchair to the stools with oak legs or a central adjustable metal base. The latter are also proposed with an external oak backrest.*

## Informazioni tecniche \ *Technical information*

### Descrizione tecnica \ *Technical description*

Sgabello con base centrale girevole in metallo tonda o quadrata con regolazione a gas, seduta e schienale imbottiti in poliuretano espanso ignifugo, schienale esterno rivestito in legno rovere. Finiture e rivestimenti di collezione.

*Stool with round or square metal swivel central base with gas height adjustment, upholstered seat and backrest with fire retardant polyurethane foam padding, external backrest in oak. Finishes and covers as per collection.*

### Dimensioni \ *Dimensions*

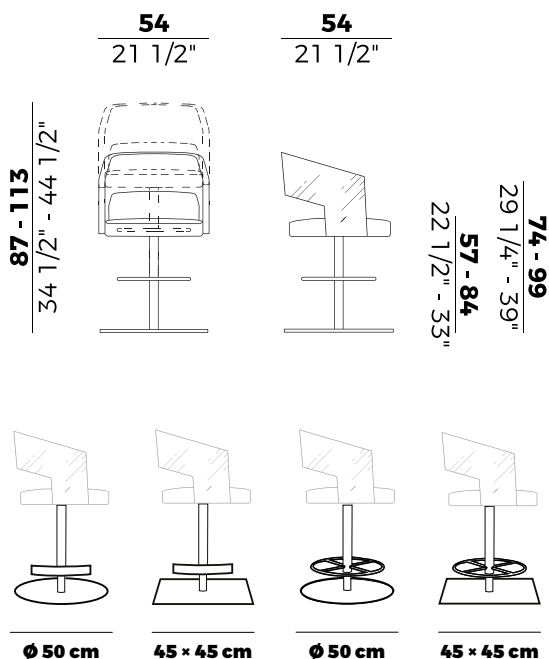

### Consumi stoffe \ *Fabric and leather requirements*

	FABRIC AND LEATHER REQUIREMENTS		FABRIC AND LEATHER REQUIREMENTS	
	x1	x2	x1	x2
H 140	ml 0,80	ml 1,60	yd 0.90	yd 1.70
H 130	ml 0,80	ml 1,60	yd 0.90	yd 1.70
LEATHER	m <sup>2</sup> 1,40		ft <sup>2</sup> 15	

PACKAGING	
1 x crt = m <sup>3</sup> 0.35	
gross weight - Kg 29.5	

## Finiture \ *Finishes*

### Finiture struttura \

*Frame finishes*

### Metallo \ *Metal*

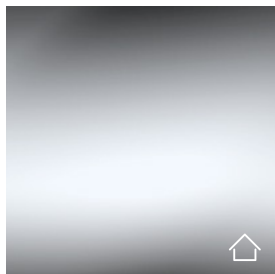

Cromato \  
Chrome

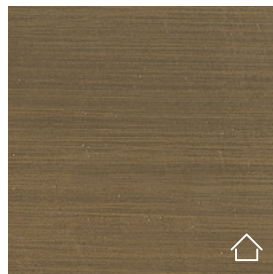

Ottone brunito \  
Bronzed Brass

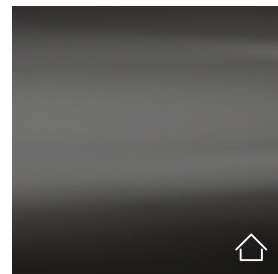

Cromo nero \  
Black Chrome

### Finiture schienale esterno \

*External backrest finishes*

### Rovere \ *Oak*



UH  
Tinto Anilina Beige \  
Beige Aniline Stained



UC  
Tinto Biscotto \  
Biscuit Stained



TD  
Tinto Moka \  
Moka Stained

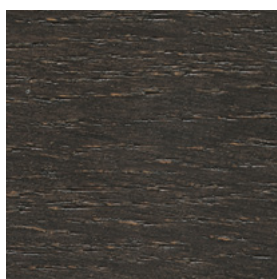

TA  
Tinto Grigio Plumbeo \  
Dark Grey Stained

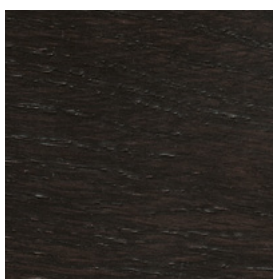

TY  
Tinto Wengé \  
Wengé Stained

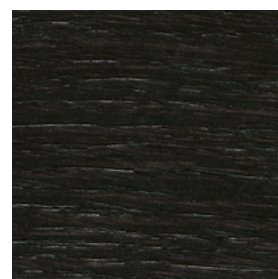

RQ  
Tinto Carbone \  
Carbon Stained

### Rivestimenti \

*Coverings*

### Tessuto, ecopelle, pelle \ *Fabric, eco-leather, leather*

**Collezione Jolly \**  
*Jolly collection*

Famiglia di sedute imbottite in poliuretano espanso ignifugo con gambe in massello di rovere.

Poltrona e sgabelli imbottiti disponibili nelle versioni:

poltrona con gambe in massello rovere, seduta e schienale imbottiti in poliuretano espanso ignifugo;

sgabello con base a quattro gambe in massello di rovere, seduta e schienale imbottiti in poliuretano espanso ignifugo;

sgabello con base centrale girevole in metallo tonda o quadrata con regolazione a gas, seduta e schienale imbottiti in poliuretano espanso ignifugo, disponibile con schienale esterno rivestito in legno rovere.

Finiture e rivestimenti di collezione.

*Family of upholstered seats with fire retardant polyurethane foam padding and legs in solid oak.*

*Upholstered armchair and stools available in the following versions:*

*armchair with legs in solid oak, upholstered seat and backrest with fire retardant polyurethane foam padding;*

*stool with four legs in solid oak, upholstered seat and backrest with fire retardant polyurethane foam padding;*

*stool with round or square metal swivel central base with gas height adjustment, upholstered seat and backrest with fire retardant polyurethane foam padding; available with external backrest in oak.*

*Finishes and covers as per collection.*

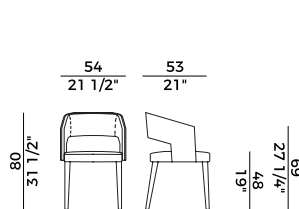

**751/PIIW**  
*poltrona \ armchair*

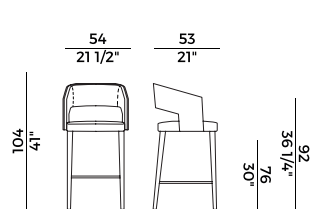

**751/AIIW**  
*sgabello alto \ barstool*

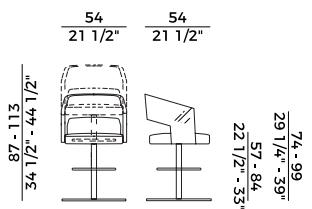

**751/AI-GAS**  
*sgabello \ stool*

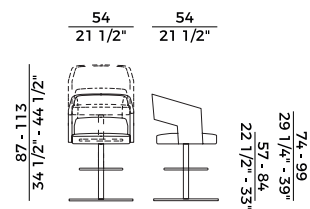

**751/AII-GAS**  
*sgabello \ stool*

design — Wolfgang C.R. Mezger



**Jolly, 751/AII-GAS**  
sgabello \ stool

La famiglia di sedute Jolly si contraddistingue per la scocca rigida ed ergonomica dello schienale, in tessuto o pelle, dalla curvatura tridimensionale, una caratteristica che attraversa tutta la famiglia, passando per le sue diverse declinazioni: poltrona, sgabello con gambe in rovere e con base centrale regolabile in metallo. Questi ultimi sono proposti, inoltre, con schienale esterno rivestito in rovere.

*The Jolly collection is characterized by seating with ergonomic shell of the backrest, made of fabric or leather, with a three-dimensional curvature, which is a feature that runs throughout the whole collection from the armchair to the stools with oak legs or a central adjustable metal base. The latter are also proposed with an external oak backrest.*

## Informazioni tecniche \ *Technical information*

### Descrizione tecnica \ *Technical description*

Sgabello con base centrale girevole in metallo tonda o quadrata con regolazione a gas, seduta e schienale imbottiti in poliuretano espanso ignifugo. Finiture e rivestimenti di collezione.

*Stool with round or square metal swivel central base with gas height adjustment, upholstered seat and backrest with fire retardant polyurethane foam padding. Finishes and covers as per collection.*

### Dimensioni \ *Dimensions*

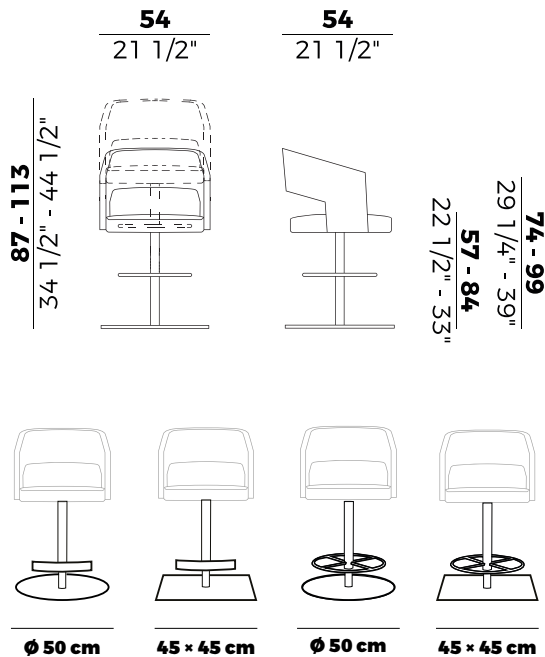

### Consumi stoffe \ *Fabric and leather requirements*

	FABRIC AND LEATHER REQUIREMENTS		FABRIC AND LEATHER REQUIREMENTS	
	x1	x2	x1	x2
H 140	ml 1,60	ml 3,20	yd 1.70	yd 3.50
H 130	ml 1,60	ml 3,20	yd 1.70	yd 3.50
LEATHER	m <sup>2</sup> 2,70		ft <sup>2</sup> 28	

PACKAGING	
1 x crt = m <sup>3</sup> 0.40	
gross weight - Kg 29.5	

## Finiture \ *Finishes*

---

### Finiture struttura \

*Frame finishes*

### Metallo \ *Metal*

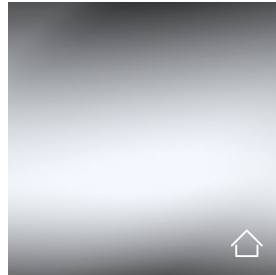

Cromato \  
Chrome

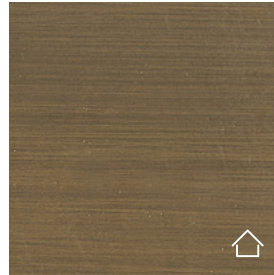

Ottone brunito \  
Bronzed Brass

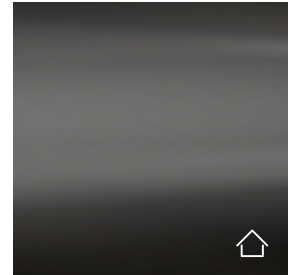

Cromo nero \  
Black Chrome

### Rivestimenti \

*Coverings*

### Tessuto, ecopelle, pelle \ *Fabric, eco-leather, leather*

**Collezione Jolly \**  
*Jolly collection*

Famiglia di sedute imbottite in poliuretano espanso ignifugo con gambe in massello di rovere.

Poltrona e sgabelli imbottiti disponibili nelle versioni:

poltrona con gambe in massello rovere, seduta e schienale imbottiti in poliuretano espanso ignifugo;

sgabello con base a quattro gambe in massello di rovere, seduta e schienale imbottiti in poliuretano espanso ignifugo;

sgabello con base centrale girevole in metallo tonda o quadrata con regolazione a gas, seduta e schienale imbottiti in poliuretano espanso ignifugo, disponibile con schienale esterno rivestito in legno rovere.

Finiture e rivestimenti di collezione.

*Family of upholstered seats with fire retardant polyurethane foam padding and legs in solid oak.*

*Upholstered armchair and stools available in the following versions:*

*armchair with legs in solid oak, upholstered seat and backrest with fire retardant polyurethane foam padding;*

*stool with four legs in solid oak, upholstered seat and backrest with fire retardant polyurethane foam padding;*

*stool with round or square metal swivel central base with gas height adjustment, upholstered seat and backrest with fire retardant polyurethane foam padding; available with external backrest in oak.*

*Finishes and covers as per collection.*

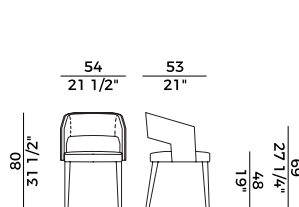

**751/PIIW**  
*poltrona \ armchair*

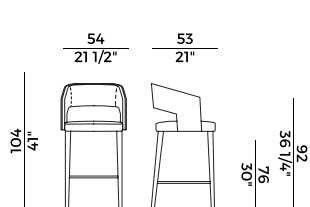

**751/AIIW**  
*sgabello alto \ barstool*

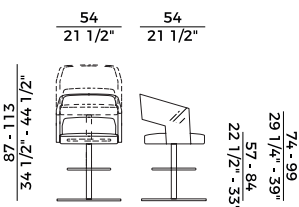

**751/AI-GAS**  
*sgabello \ stool*

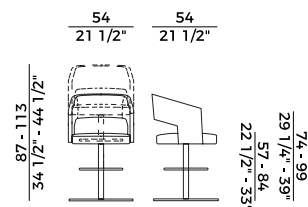

**751/AII-GAS**  
*sgabello \ stool*