

design — Wolfgang C.R. Mezger



**Jolly, 751/AIIW**  
sgabello alto \ *barstool*

La famiglia di sedute Jolly si contraddistingue per la scocca rigida ed ergonomica dello schienale, in tessuto o pelle, dalla curvatura tridimensionale, una caratteristica che attraversa tutta la famiglia, passando per le sue diverse declinazioni: poltrona, sgabello con gambe in rovere e con base centrale regolabile in metallo. Questi ultimi sono proposti, inoltre, con schienale esterno rivestito in rovere.

*The Jolly collection is characterized by seating with ergonomic shell of the backrest, made of fabric or leather, with a three-dimensional curvature, which is a feature that runs throughout the whole collection from the armchair to the stools with oak legs or a central adjustable metal base. The latter are also proposed with an external oak backrest.*

## Informazioni tecniche \ *Technical information*

### Descrizione tecnica \ *Technical description*

Sgabello alto con gambe in massello rovere, seduta e schienale imbottiti in poliuretano espanso ignifugo. Finiture e rivestimenti di collezione.

*Upholstered barstool with legs in solid oak, upholstered seat and backrest with fire retardant polyurethane foam padding. Finishes and covers as per collection.*

### Dimensioni \ *Dimensions*

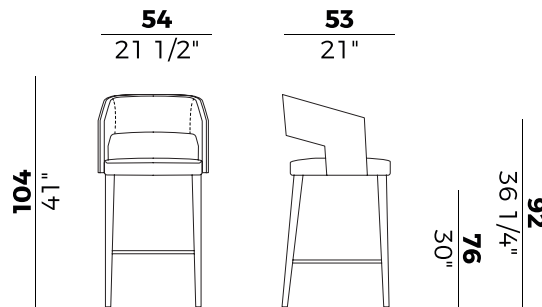

### Consumi stoffe \ *Fabric and leather requirements*

	FABRIC AND LEATHER REQUIREMENTS			FABRIC AND LEATHER REQUIREMENTS	
	x1	x2		x1	x2
<b>H 140</b>	ml 1,60	ml 3,20	<b>H 140</b>	yd 1.70	yd 3.50
<b>H 130</b>	ml 1,60	ml 3,20	<b>H 130</b>	yd 1.70	yd 3.50
<b>LEATHER</b>	m <sup>2</sup> 2,70		<b>LEATHER</b>	ft <sup>2</sup> 28	

PACKAGING	
	1 x crt = m <sup>3</sup> 0,40
	gross weight - Kg 14

## Finiture \ *Finishes*

### Finiture struttura \

*Frame finishes*

### Rovere \ *Oak*



UH  
Tinto Anilina Beige \  
Beige Aniline Stained



UC  
Tinto Biscotto \  
Biscuit Stained

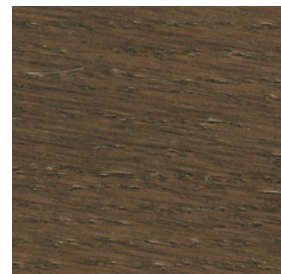

TD  
Tinto Moka \  
Moka Stained



TA  
Tinto Grigio Plumbeo \  
Dark Grey Stained

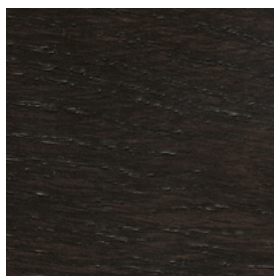

TY  
Tinto Wengé \  
Wengé Stained



RQ  
Tinto Carbone \  
Carbon Stained

### Rivestimenti \

*Coverings*

### Tessuto, ecopelle, pelle \ *Fabric, eco-leather, leather*

**Collezione Jolly \**  
*Jolly collection*

Famiglia di sedute imbottite in poliuretano espanso ignifugo con gambe in massello di rovere.

Poltrona e sgabelli imbottiti disponibili nelle versioni:

poltrona con gambe in massello rovere, seduta e schienale imbottiti in poliuretano espanso ignifugo;

sgabello con base a quattro gambe in massello di rovere, seduta e schienale imbottiti in poliuretano espanso ignifugo;

sgabello con base centrale girevole in metallo tonda o quadrata con regolazione a gas, seduta e schienale imbottiti in poliuretano espanso ignifugo, disponibile con schienale esterno rivestito in legno rovere.

Finiture e rivestimenti di collezione.

*Family of upholstered seats with fire retardant polyurethane foam padding and legs in solid oak.*

*Upholstered armchair and stools available in the following versions:*

*armchair with legs in solid oak, upholstered seat and backrest with fire retardant polyurethane foam padding;*

*stool with four legs in solid oak, upholstered seat and backrest with fire retardant polyurethane foam padding*

*stool with round or square metal swivel central base with gas height adjustment, upholstered seat and backrest with fire retardant polyurethane foam padding; available with external backrest in oak.*

*Finishes and covers as per collection.*

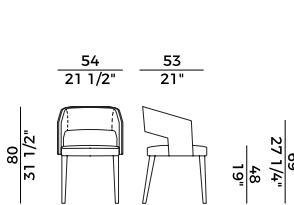

**751/PIIW**  
*poltrona \ armchair*

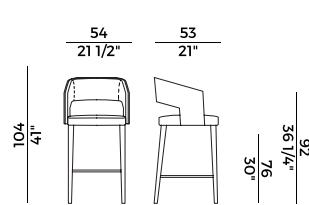

**751/AIIW**  
*sgabello alto \ barstool*

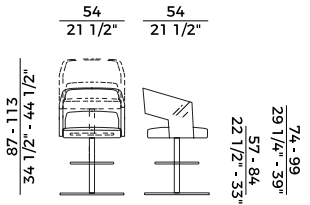

**751/AI-GAS**  
*sgabello \ stool*

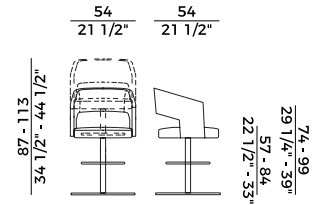

**751/AII-GAS**  
*sgabello \ stool*