

design — David Lopez Quincoces



**Loom, 880/DC**  
divano \ sofa

Ispirazione retrò per la collezione Loom composta da divano, lounge e day bed. Minimalismo e semplicità definiscono il progetto: a disegnarne il profilo, è presentata un'essenziale cornice in mogano con inserto in giunco intrecciato a tela, eco di una tradizione artigianale ed espressione di una profonda abilità manuale. La collezione è disponibile anche nella versione per esterni con intreccio in corda.

*A retrò inspiration for the Loom collection, consisting of sofa, armchair and day-bed. Minimalism and simplicity define the design: to outline its profile, a mahogany frame with a woven reed insert, the echo of a craft tradition and the expression of a deep manual ability. The collection is also available in the outdoor version with rope weaving.*

## Informazioni tecniche \ *Technical information*

### Descrizione tecnica \ *Technical description*

Divano nella versione indoor.  
Struttura in massello di mogano con inserti in canna naturale.  
Piedini in metallo. Cuscinatura interna in poliuretano espanso ignifugo.  
Finiture e rivestimenti di collezione.

*Sofa for indoor.  
Solid mahogany frame with natural cane inserts.  
Metal feet. Cushions in fire retardant polyurethane foam padding.  
Finishes and covers as per collection.*

### Dimensioni \ *Dimensions*

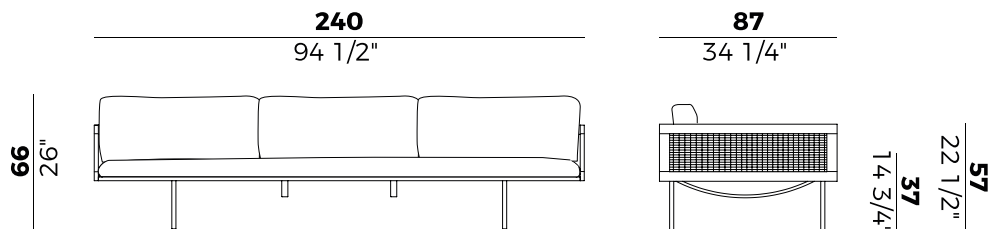

### Consumi stoffe \ *Fabric and leather requirements*

	FABRIC AND LEATHER REQUIREMENTS		FABRIC AND LEATHER REQUIREMENTS	
	x1	x2	x1	x2
<b>H 140</b>	ml 5,00	ml 10,00	yd 5.50	yd 10.90
<b>H 130</b>	ml 5,00	ml 10,00	yd 5.50	yd 10.90
<b>LEATHER</b>	m <sup>2</sup> 10,50		ft <sup>2</sup> 110	

PACKAGING	
1 × crt = m <sup>3</sup>	<b>2.13</b>
gross weight - Kg <b>84</b>	

## Informazioni tecniche \ *Technical information*

### Descrizione tecnica \ *Technical description*

Divano nella versione indoor.  
Struttura in massello di mogano con inserti in canna naturale.  
Piedini in metallo. Cuscinatura interna in poliuretano espanso ignifugo.  
Finiture e rivestimenti di collezione.

*Sofa for indoor.  
Solid mahogany frame with natural cane inserts.  
Metal feet. Cushions in fire retardant polyurethane foam padding.  
Finishes and covers as per collection.*

### Dimensioni \ *Dimensions*

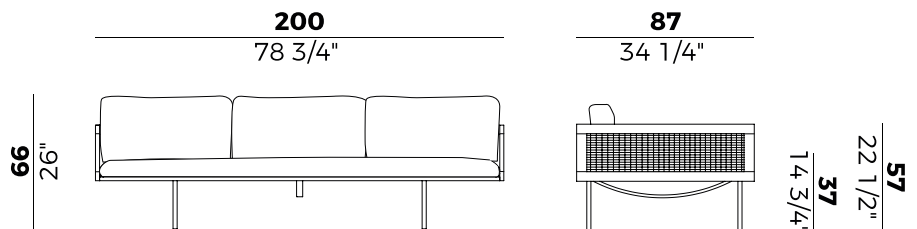

### Consumi stoffe \ *Fabric and leather requirements*

	FABRIC AND LEATHER REQUIREMENTS	
	x1	x2
H 140	ml 5,00	ml 10,00
H 130	ml 5,00	ml 10,00
LEATHER	m <sup>2</sup> 10,50	

	FABRIC AND LEATHER REQUIREMENTS	
	x1	x2
H 140	yd 5.00	yd 10.10
H 130	yd 5.00	yd 10.10
LEATHER	ft <sup>2</sup> 100	

PACKAGING	
1 x crt = m <sup>3</sup> 1,8	
gross weight - Kg 70	

## Informazioni tecniche \ *Technical information*

### Descrizione tecnica \ *Technical description*

Divano componibile composto da un elemento destro e sinistro e da una chaise longue nella versione indoor. Struttura in massello di mogano con inserti in giunco intrecciato a tela. Piedini in metallo ottone brunito o antracite. Cuscineria interna con imbottitura.

*Modular sofa made up of a right-hand module and a left-hand one and a chaise longue in the indoor version. Structure in solid mahogany with inserts in woven rush fabric. Feet in anthracite or burnished brass metal. Inside cushions with padding.*

### Dimensioni \ *Dimensions*

#### 880/DCL, 880/DRL

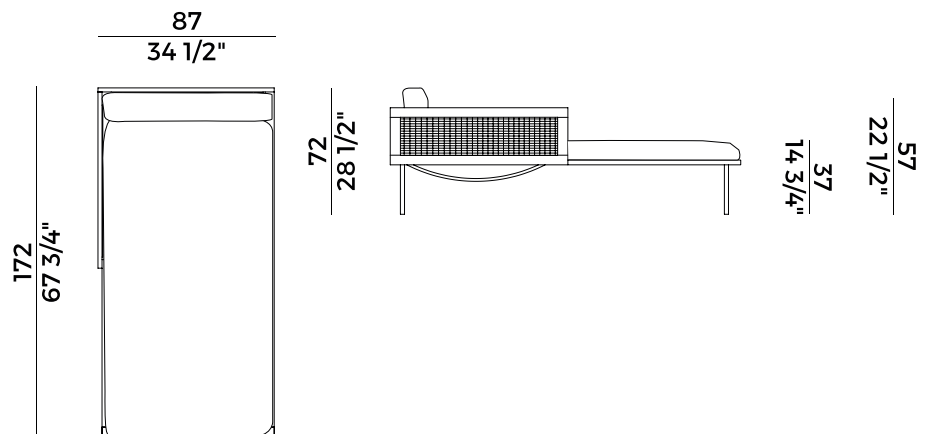

#### 880/DCM, 880/DRM

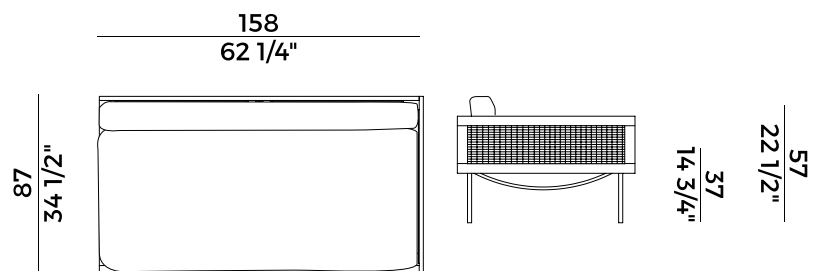

### Consumi stoffe \ *Fabric and leather requirements*

	FABRIC AND LEATHER REQUIREMENTS			FABRIC AND LEATHER REQUIREMENTS	
	x1	x2		x1	x2
<b>H 140</b>	ml 5,00	ml 10,00	<b>H 140</b>	yd 5.50	yd 11.00
<b>H 130</b>	ml 5,00	ml 10,00	<b>H 130</b>	yd 5.50	yd 11.00
<b>LEATHER</b>	m <sup>2</sup> 10,50		<b>LEATHER</b>	ft <sup>2</sup> 114	

## Finiture \ *Finishes*

### Finiture piedino \

*Legs finishes*

### Metallo \ *Metal*

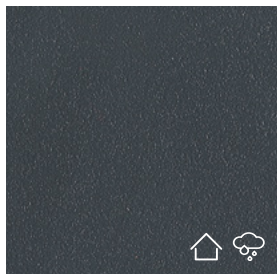

Verniciato Antracite Goffrato \  
Anthracite Embossed Lacquered

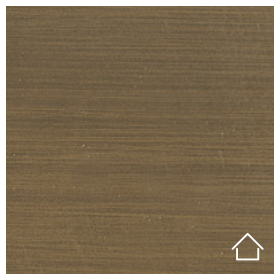

Ottone Brunito \  
Bronzed Brass

### Finiture struttura \

*Frame finishes*

### Mogano \ *Mahogany*

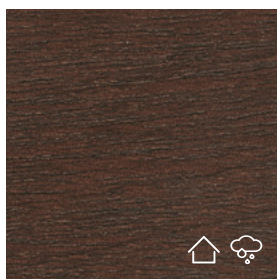

EK  
Mogano Tinto Noce \  
Mahogany Walnut Stained

### Canna \ *Cane*

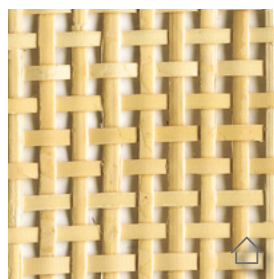

Canna naturale \  
Natural Cane

### Rivestimenti \

*Coverings*

### Tessuto, ecopelle, pelle \ *Fabric, eco-leather, leather*

**Collezione Loom \**  
*Loom collection*

Collezione di divani, lounge e day-bed nella versione indoor e outdoor.  
Struttura in massello di mogano con inserti in canna naturale e in cordino "Gassa" o cordino sintetico per la versione da esterno.  
Piedini in metallo. Cuscinatura interna in poliuretano espanso ignifugo.  
Finiture e rivestimenti di collezione.

*Collection of sofas, lounge armchairs and day-beds for indoor and outdoor. Solid mahogany frame with natural cane inserts and "Gassa" or synthetic rope for the outdoor version. Metal feet. Cushions in fire retardant polyurethane foam padding. Finishes and covers as per collection.*

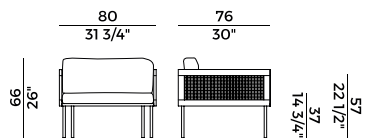

880/PC 880/PR-OUT ☼  
*lounge \ lounge armchair*

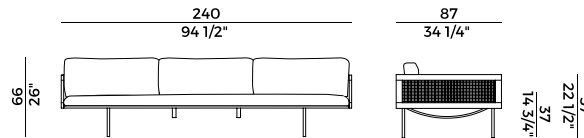

880/DC 880/DR-OUT ☼  
*divano \ sofa*

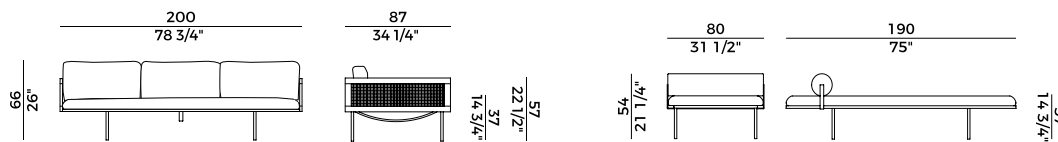

880/DC-200 880/DR-200-OUT ☼ 880/DB 880/DB-OUT ☼  
*divano \ sofa day-bed \ day-bed*

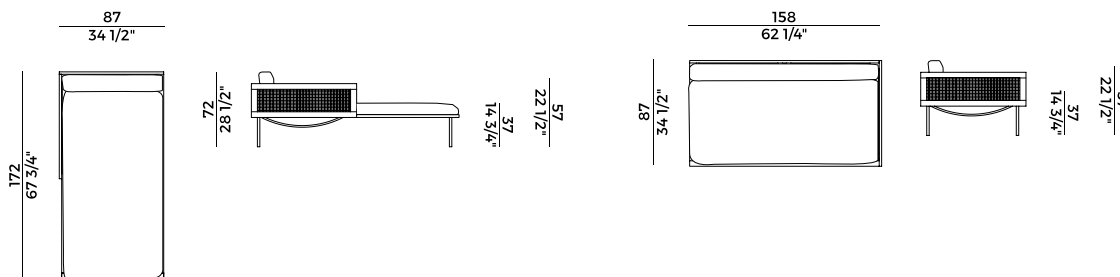

880/DCL 880/DRL ☼ 880/DCM 880/DRM ☼  
*divano componibile \ modular sofa divano componibile \ modular sofa*

