

design — David Lopez Quincoces



**Loom, 880/DCL-DCM**  
divano componibile \ modular sofa

Ispirazione retrò per il divano componibile Loom che permette di accostare a scelta elementi angolari, destro e sinistro, e chaise-longue, destra e sinistra, per creare la soluzione desiderata. Minimalismo e semplicità definiscono il progetto: a disegnarne il profilo, un'essenziale cornice in mogano con inserto in giunco intrecciato a tela, eco di una tradizione artigianale. Il divano è disponibile anche nella versione per esterni con intreccio in corda.

*Retrò inspiration for the Loom modular sofa that allows, by choosing between right and left corner elements and right and left chaiselongue, creating the desired solution. Minimalism and elegant simplicity define the project: to draw the profile is an essential mahogany frame enclosing a refined cane weave, echoing a traditional craftsmanship. The sofa is also available in the outdoor version with synthetic rope weaving.*

## Informazioni tecniche \ *Technical information*

### Descrizione tecnica \ *Technical description*

Divano componibile composto da un elemento destro e sinistro e da una chaise longue nella versione indoor. Struttura in massello di mogano con inserti in giunco intrecciato a tela. Piedini in metallo ottone brunito o antracite. Cuscineria interna con imbottitura.

*Modular sofa made up of a right-hand module and a left-hand one and a chaise longue in the indoor version. Structure in solid mahogany with inserts in woven rush fabric. Feet in anthracite or burnished brass metal. Inside cushions with padding.*

### Dimensioni \ *Dimensions*

#### 880/DCL, 880/DRL

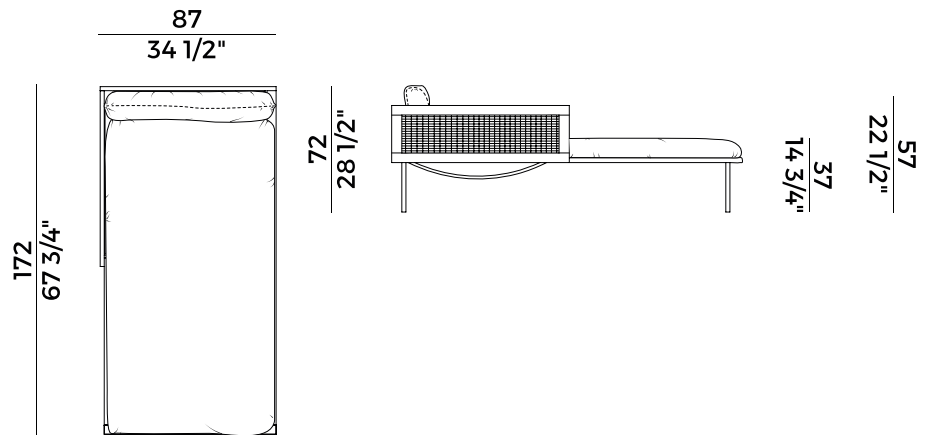

#### 880/DCM, 880/DRM

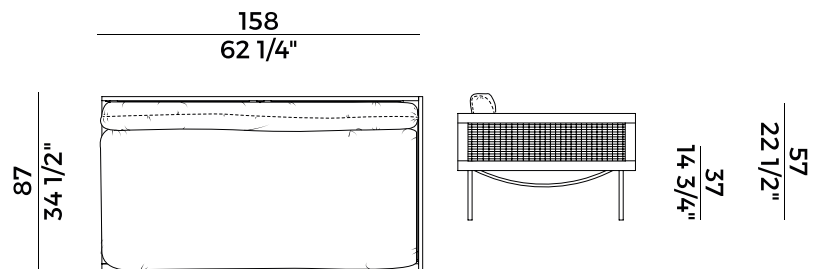

### Consumi stoffe \ *Fabric and leather requirements*

	FABRIC AND LEATHER REQUIREMENTS			FABRIC AND LEATHER REQUIREMENTS	
	x1	x2		x1	x2
<b>H 140</b>	ml 5,00	ml 10,00	<b>H 140</b>	yd 5.50	yd 11.00
<b>H 130</b>	ml 5,00	ml 10,00	<b>H 130</b>	yd 5.50	yd 11.00
<b>LEATHER</b>	m <sup>2</sup> 10,50		<b>LEATHER</b>	ft <sup>2</sup> 114	

## Finiture \ *Finishes*

---

### Finiture piedino \

*Legs finishes*

### Metallo \ *Metal*

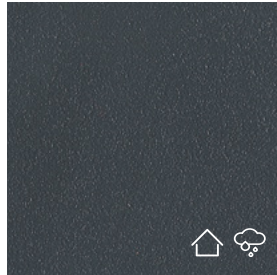

Verniciato Antracite Goffrato \  
Anthracite Embossed Lacquered

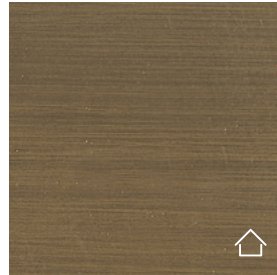

Ottone Brunito \  
Bronzed Brass

### Finiture struttura \

*Frame finishes*

### Mogano \ *Mahogany*

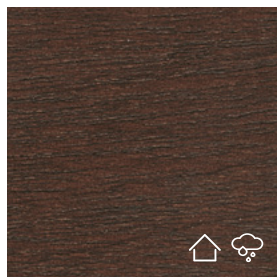

EK  
Mogano Tinto Noce \  
Mahogany Walnut Stained

### Canna \ *Cane*



Canna naturale \  
Natural Cane

### Rivestimenti \

*Coverings*

### Tessuto, ecopelle, pelle \ *Fabric, eco-leather, leather*

**Collezione Loom \**  
*Loom collection*

Divano componibile composto da un elemento destro e sinistro e da una chaise longue nella versione indoor e outdoor.

Struttura in massello di mogano con inserti in giunco intrecciato a tela o in cordino "Gassa" per la versione da esterno. Piedini in metallo ottone brunito o antracite per outdoor. Cuscineria interna con imbottitura per indoor e outdoor.

*Modular sofa made up of a right-hand module and a left-hand module and a chaise longue in the indoor and outdoor version.*

*Structure in solid mahogany with inserts in woven rush fabric or in "Gassa" cord for the outdoor version. Feet in anthracite or burnished brass metal for outdoors. Inside cushions with padding for indoor and outdoor use.*

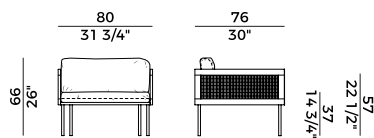

880/PC 880/PR-OUT ↻  
*lounge \ lounge armchair*

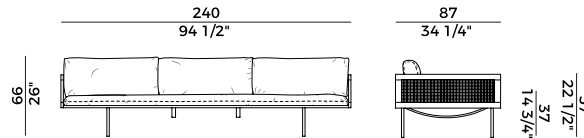

880/DC 880/DR-OUT ↻  
*divano \ sofa*

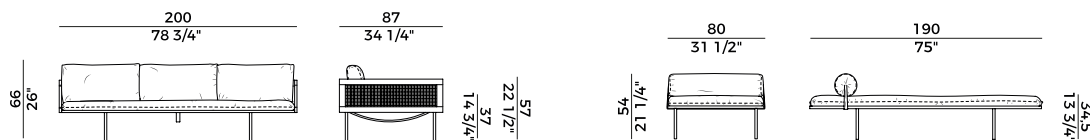

880/DC-200 880/DR-200-OUT ↻ 880/DB 880/DB-OUT ↻  
*divano \ sofa day-bed \ day-bed*

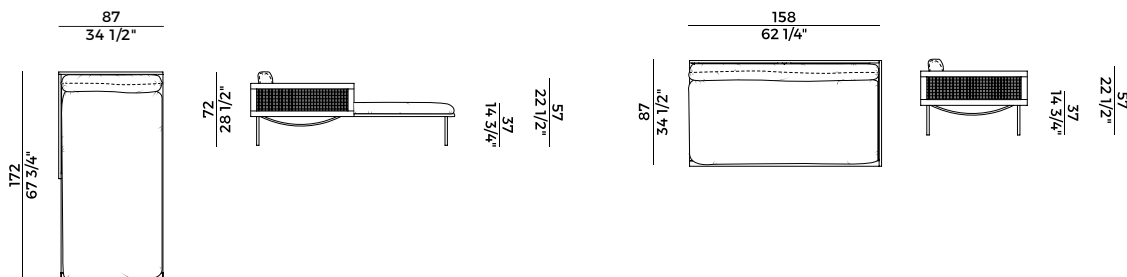

880/DCL 880/DRL ↻ 880/DCM 880/DRM ↻  
*divano componibile \ modular sofa*

