

design — Enrico Franzolini e Cristian Malisan



Miura, 776/AW
sgabello \ stool

Famiglia di sedute composta da sedia, poltrona e sgabello, Miura si distingue per le morbide curve e le sapienti cuciture a vista sul rivestimento in tessuto o pelle. Nella poltrona, disponibile anche nella versione con gambe in faggio imbottite, il profilo dello schienale si estende per rendere piacevole l'appoggio delle braccia, mentre, nella versione sedia, il disegno acquista una leggerezza inedita.

A family of seating consisting of a chair, armchair and stool, Miura stands out for its soft curves and the crafted stitching on the fabric or leather upholstery. In the armchair, also available in the upholstered version with beech legs, the backrest profile extends to create a pleasant armrest, while in the chair version, the design acquires a new form of lightness.

Informazioni tecniche \ *Technical information*

Descrizione tecnica \ *Technical description*





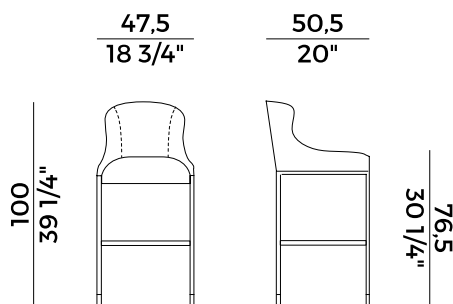

Sgabello imbottito in poliuretano espanso ignifugo con gambe in massello di faggio. Piedino finitura metallo. Finiture e rivestimenti di collezione.

Upholstered stool with fire retardant polyurethane foam padding and solid beech legs. Metal finish foot. Finishes and covers as per collection.

Dimensioni \ *Dimensions*



Consumi stoffe \ *Fabric and leather requirements*

FABRIC / LEATHER REQUIREMENTS				FABRIC / LEATHER REQUIREMENTS			
		x1	x2			x1	x2
	H 140	ml 1,30	ml 2,60		H 140	yd 1.45	yd 2.85
	LEATHER	m ² 2,60			LEATHER	ft ² 28	
	PACKAGING				PACKAGING		
	1 x crt = m ³ 0.32				1 x crt = m ³ 0.32		
	gross weight - Kg 14				gross weight - Kg 14		

Finiture \ *Finishes*

Finiture piedino \

Feet finishes

Metallo \ *Metal*

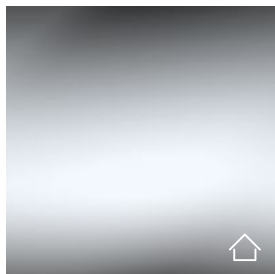

Cromato \
Chrome

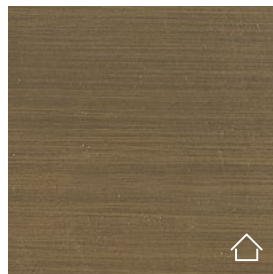

Ottone brunito \
Bronzed Brass

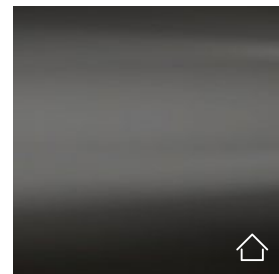

Cromo nero \
Black Chrome

Finiture struttura \

Frame finishes

Faggio \ *Beech*

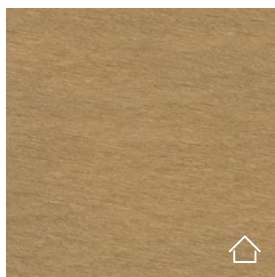

BV
Tinto Anilina Beige \
Beige Aniline Stained

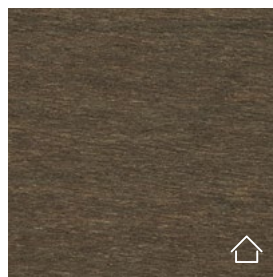

UD
Tinto Biscotto \
Biscuit Stained



TM
Tinto Moka \
Moka Stained

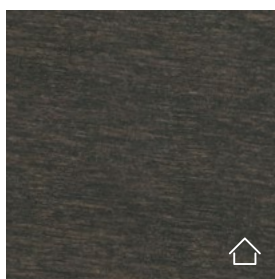

TZ
Tinto Grigio Plumbeo \ Dark
Grey Stained

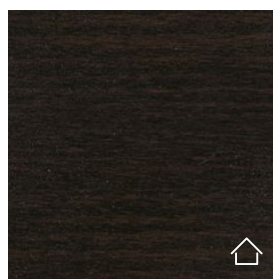

TT
Tinto Wengé \
Wengé Stained

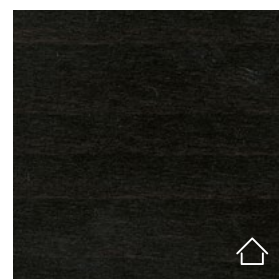

15
Tinto Carbone \
Carbon Stained

Rivestimenti \

Coverings

Tessuto, ecopelle, pelle \ *Fabric, eco-leather, leather*

**Collezione Miura **
Miura collection

Famiglia di sedute e sgabello
imbottiti in poliuretano espanso
ignifugo con gambe in massello di
faggio. Piedino finitura metallo.
Poltrona disponibile interamente
imbottita.
Finiture e rivestimenti di collezione.

*Family of upholstered seats and stools with
fire retardant polyurethane foam padding
and solid beech legs. Metal finish foot.
Fully upholstered armchair also available.
Materials and coverings as per collection.*

