

design — Gabriele e Oscar Buratti



**OTX, 887/TC**  
**tavolo \ table**

Versatili e dal design essenziale i tavoli OTX con gamba centrale e quattro piedini, sono caratterizzati da un piano reclinabile verticalmente in HPL, tondo o quadrato, in tre dimensioni differenti, per poterli accostare uno accanto all'altro. Estremamente funzionali, sono inoltre proposti in due altezze per diversi utilizzi, da spazi collettivi a bar, in ambienti indoor e outdoor.

*Versatile and with a minimalist design, the OTX tables, with central leg and four feet, are characterized by a vertically reclining top in HPL, available in the two round and square versions, in order to store them side by side. Extremely functional, the tables are also proposed in two heights for different uses, from collective spaces to bars, for both indoor and outdoor environments.*

## Informazioni tecniche \ *Technical information*

### Descrizione tecnica \ *Technical description*

Tavolo per utilizzo indoor e outdoor con piano pieghevole.  
Base in metallo. Piano tondo in HPL.  
Disponibile in tre dimensioni.

*Small table for indoor and outdoor use with folding top.  
Base in metal. Round top in HPL.  
Available in three sizes.*

### Dimensioni \ *Dimensions*

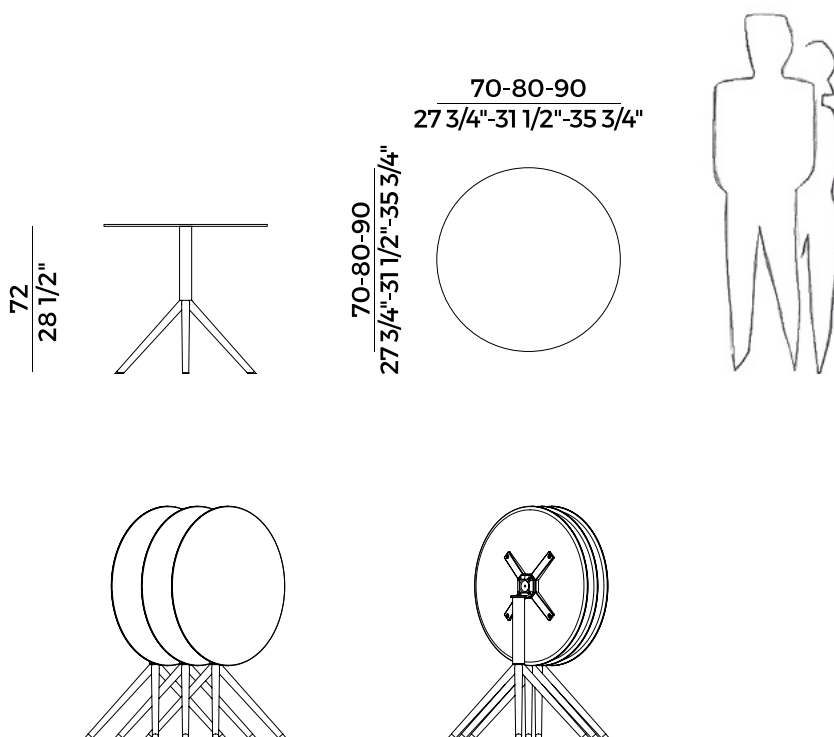

	<b>Ø 70</b>
nano-tech resin - 2 crt = m <sup>3</sup> <b>0.36</b>	
HPL - 2 crt = m <sup>3</sup> <b>0.36</b>	
nano-tech resin gross weight - Kg <b>26</b>	
HPL gross weight - Kg <b>26</b>	

	<b>Ø 80</b>
nano-tech resin - 2 crt = m <sup>3</sup> <b>0.36</b>	
HPL - 2 crt = m <sup>3</sup> <b>0.36</b>	
nano-tech resin gross weight - Kg <b>28,5</b>	
HPL gross weight - Kg <b>28,5</b>	

	<b>Ø 90</b>
nano-tech resin - 2 crt = m <sup>3</sup> <b>0.40</b>	
HPL - 2 crt = m <sup>3</sup> <b>0.40</b>	
nano-tech resin gross weight - Kg <b>25</b>	
HPL gross weight - Kg <b>25</b>	

## Finiture \ *Finishes*

### Finiture base \

*Base finishes*

### Metallo \ *Metal*

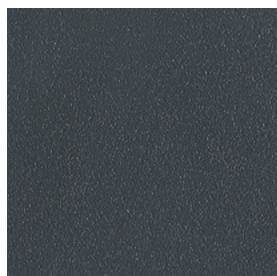

Verniciato Antracite Goffrato \  
Anthracite Embossed Lacquered

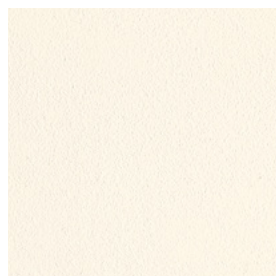

Verniciato Bianco Goffrato \  
White Embossed Lacquered



Verniciato Aval Goffrato \  
Aval Embossed Lacquered

### Finiture piano \

*Top finishes*

### HPL \ *HPL*

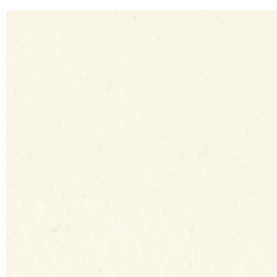

Bianco \  
White

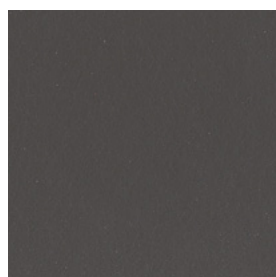

Antracite \  
Anthracite



Orchidea \  
Orchid

### Resina nano-tech \ *Nano-tech resin*

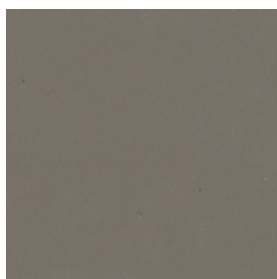

Grigio Londra \  
London Grey

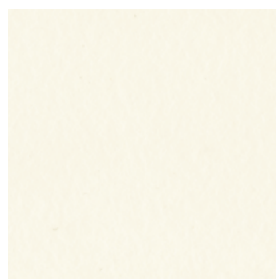

Bianco \  
White

**Collezione OTX \**  
*OTX collection*

Famiglia di tavolini per utilizzo indoor e outdoor con piano pieghevole.  
Base in metallo. Piano in HPL.  
Disponibile in due altezze e tre dimensioni con piano tondo o quadrato.  
Tavolo tondo con base in metallo verniciata. Per la versione indoor, il piano è in frassino o resina nano-tech; per la versione outdoor il piano è in HPL.  
Finiture di collezione.

*Set of small tables for indoor and outdoor use with folding top.  
Base in metal. Top in HPL.  
Available in two heights and three sizes with round or square top.  
Circular table with painted metal base. For indoor use, the top is in ash wood or nano-tech resin; for the outdoor version the top is in HPL. Finishes as per collection.*

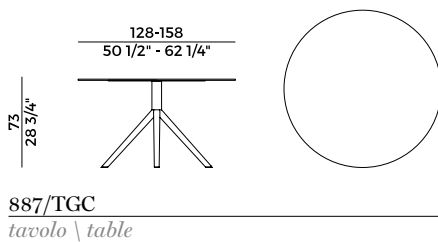
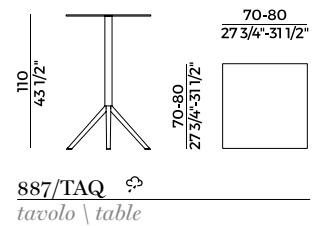
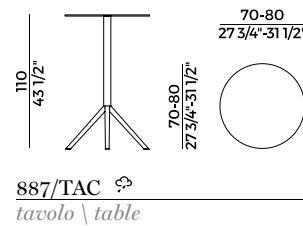
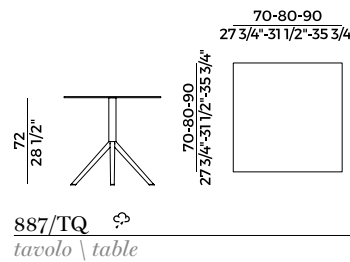
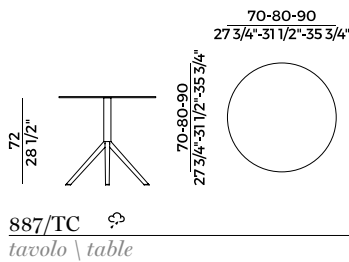

design — Gabriele e Oscar Buratti



**OTX, 887/TAC**  
**tavolo \ table**

Versatili e dal design essenziale i tavoli OTX con gamba centrale e quattro piedini, sono caratterizzati da un piano reclinabile verticalmente in HPL, tondo o quadrato, in tre dimensioni differenti, per poterli accostare uno accanto all'altro. Estremamente funzionali, sono inoltre proposti in due altezze per diversi utilizzi, da spazi collettivi a bar, in ambienti indoor e outdoor.

*Versatile and with a minimalist design, the OTX tables, with central leg and four feet, are characterized by a vertically reclining top in HPL, available in the two round and square versions, in order to store them side by side. Extremely functional, the tables are also proposed in two heights for different uses, from collective spaces to bars, for both indoor and outdoor environments.*

## Informazioni tecniche \ *Technical information*

### Descrizione tecnica \ *Technical description*

Tavolo alto per utilizzo indoor e outdoor con piano pieghevole.  
Base in metallo. Piano tondo in HPL.  
Disponibile in due dimensioni.

*Hight table for indoor and outdoor use with folding top.  
Base in metal. Round top in HPL.  
Available in two sizes.*

### Dimensioni \ *Dimensions*

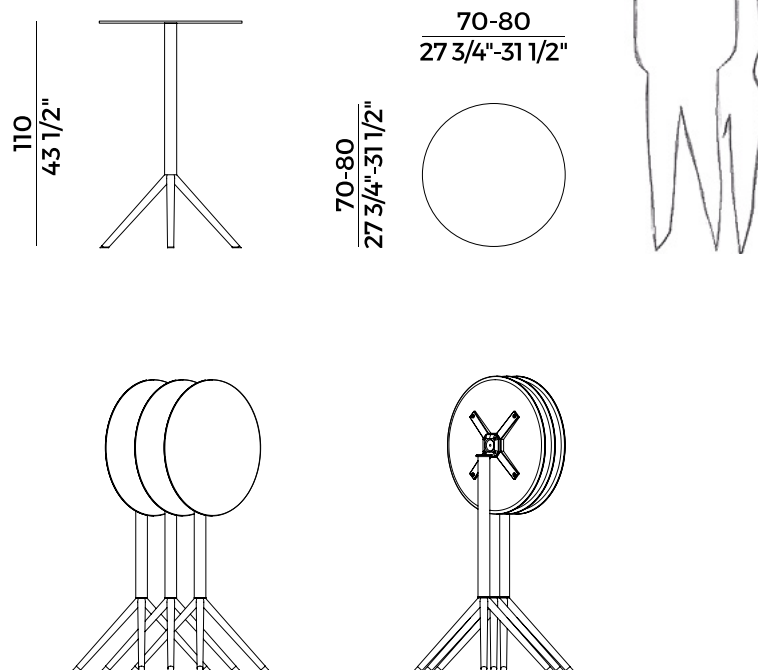

**Ø 70**

nano-tech resin - 2 crt = m<sup>3</sup> **0.42**

HPL - 2 crt = m<sup>3</sup> **0.42**

nano-tech resin gross weight - Kg **27,1**

HPL gross weight - Kg **27,1**



**Ø 80**

nano-tech resin - 2 crt = m<sup>3</sup> **0.42**

HPL - 2 crt = m<sup>3</sup> **0.42**

nano-tech resin gross weight - Kg **29,6**

HPL gross weight - Kg **29,6**

## Finiture \ *Finishes*

### Finiture base \

*Base finishes*

### Metallo \ *Metal*

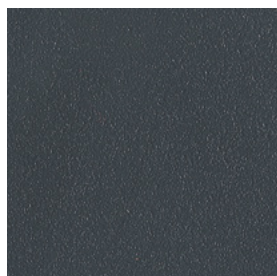

Verniciato Antracite Goffrato \  
Anthracite Embossed Lacquered

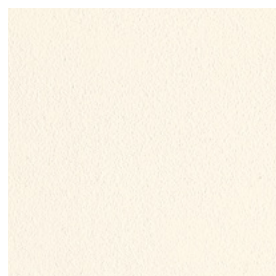

Verniciato Bianco Goffrato \  
White Embossed Lacquered



Verniciato Aval Goffrato \  
Aval Embossed Lacquered

### Finiture piano \

*Top finishes*

### HPL \ *HPL*

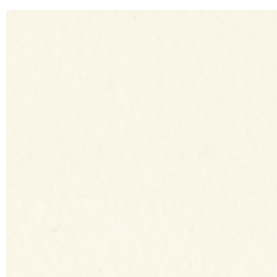

Bianco \  
White

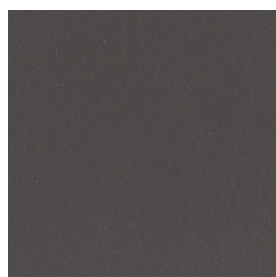

Antracite \  
Anthracite



Orchidea \  
Orchid

### Resina nano-tech \ *Nano-tech resin*

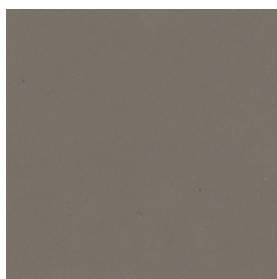

Grigio Londra \  
London Grey

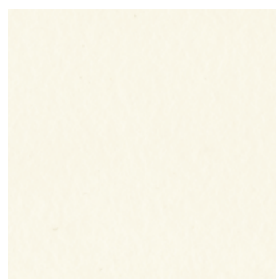

Bianco \  
White

**Collezione OTX \**  
*OTX collection*

Famiglia di tavolini per utilizzo indoor e outdoor con piano pieghevole. Base in metallo. Piano in HPL. Disponibile in due altezze e tre dimensioni con piano tondo o quadrato. Tavolo tondo con base in metallo verniciata. Per la versione indoor, il piano è in frassino o resina nano-tech; per la versione outdoor il piano è in HPL. Finiture di collezione.

*Set of small tables for indoor and outdoor use with folding top. Base in metal. Top in HPL. Available in two heights and three sizes with round or square top. Circular table with painted metal base. For indoor use, the top is in ash wood or nano-tech resin; for the outdoor version the top is in HPL. Finishes as per collection.*

