

big wave

DESIGN LUDOVICA
+ ROBERTO PALOMBA

modello registrato
registered model

portata sul piano: 150 kg
load capacity on top: 150 kg
art. BW-300, BW-360: 200 kg

Tavolo con base composta da quattro o sei elementi in DV Glass da 30 mm trasparente o a strisce colorate. Piano in vetro da 15 mm trasparente retroverniciato con tinte monocromatiche, oppure ricoperto in Ecomalta, spatolatura tipo fine, oppure in legno impiallacciato noce canaletto finitura antracite opaco.

Table with base made of four or six separate 30 mm DV Glass elements, transparent or with colored stripes. Top made of 15 mm transparent glass, back-lacquered with monochrome color or hand-finished with Ecomalta, finer-grained texture finish, or in Canaletto walnut veneered wood, matt anthracite finish.



SOLO VERSIONE CON TOP IN LEGNO
ONLY WITH WOOD TOP

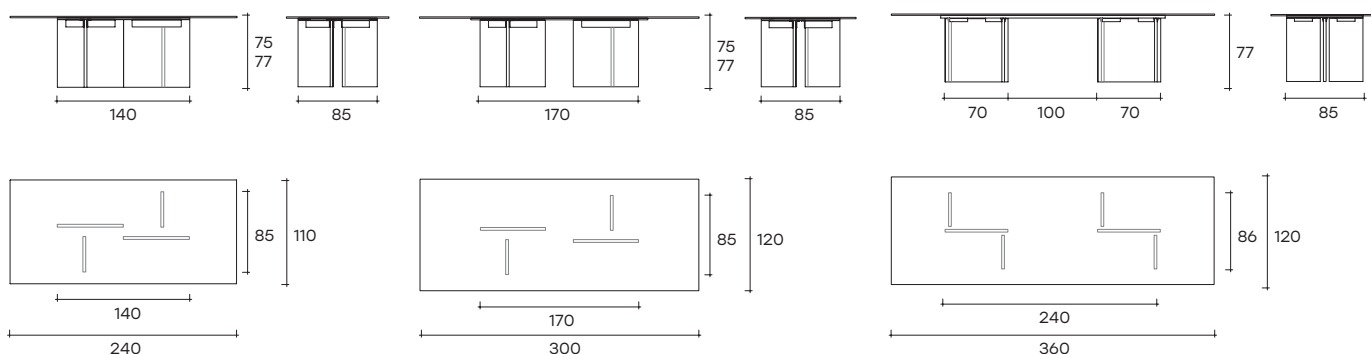

STRUTTURA DV-GLASS® DV-GLASS® STRUCTURE

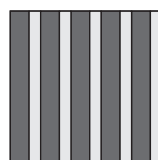
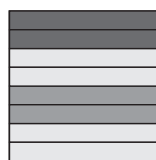
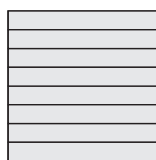

-  Trasparente
Transparent
-  Fumè
Smoke
-  Bronzo
Bronze

Per combinazioni su richiesta,
contattare il customer service.

For customized compositions
please contact Fiam customer service.

dimensioni L, P, H
dimensions L, W, H
(cm)

	COD./CODE	L	P/W	H	peso netto net weight (kg)	peso lordo gross weight (kg)	volume imballo package volume (m³)
Tavolo con piano in vetro trasparente retroverniciato in tinta Cat.1. Base in DV Glass trasparente. Table with top in transparent glass, back-lacquered - color Cat.1. Base in transparent DV glass.	BW-TR240/V-	240	110	75	237	316	0,9
	BW-TR300/V-	300	120	75	278	373	1,05
Tavolo con piano in vetro trasparente retroverniciato in tinta Cat.1. Base in DV Glass a strisce colorate. Table with top in transparent glass, back-lacquered - color Cat.1. Base made of colored DV glass.	BW-CO240/V-	240	110	75	237	316	0,9
	BW-CO300/V-	300	120	75	278	373	1,05
Tavolo con piano in vetro ricoperto in Ecomalta, spatolatura tipo fine. Base in DV Glass trasparente. Table with glass top hand-finished with ecomalta, finer-grained texture finish. Base in transparent DV glass.	BW-TR240/ECO-	240	110	75	237	316	0,9
	BW-TR300/ECO-	300	120	75	278	373	1,05

dimensioni L, P, H dimensions L, W, H (cm)	COD./CODE	L	P/W	H	peso netto net weight (kg)	peso lordo gross weight (kg)	volume imballo package volume (m ³)
Tavolo con piano in vetro ricoperto in Ecomalta, spatolatura tipo fine. Base in DV Glass a strisce colorate. <i>Table with glass top hand-finished with ecomalta, finer-grained texture finish. Base made of colored DV glass.</i>	BW-CO240/ECO-	240	110	75	237	316	0,9
	BW-CO300/ECO-	300	120	75	278	373	1,05
Tavolo con piano in legno impiallacciato noce canaletto finitura antracite opaco. Base in DV Glass a strisce fumè e trasparenti. <i>Table with Canaletto walnut veneered wood, matt anthracite finish. Base in DV-Glass made of smoked and transparent vertical fused glass stripes.</i>	BW-FU240/N	240	110	77	213	250	0,64
	BW-FU300/N	300	110	77	245	283	0,72
	BW-FU360/N	360	110	77	313	363	0,92

VETRO RETROVERNICIATO _ BACK PAINTED GLASS

CAT. COLORE COLOR CAT.	COLORI COLORS	CODICE _ CODE
		Vetro trasparente _ Transparent glass
CAT.1 Tinta unita Plain color	Grigio grafite Grey graphite	V-GR
	Rosso vinaccia Wine red	V-VI
	Testa di moro Dark brown	V-MR

FINITURE ECOMALTA _ ECOMALTA FINISHES

FINITURE FINISHES	Avorio Ivory	Tortora Dove grey	Nero Ardesia Black slate	Argilla Clay brown	Fango Mud brown	Calce Lime grey
CODICE CODE	TBP	TNR	MNA	MAR	M25	M42

Per altre finiture fare riferimento alla tabella nella bandella di copertina.

Per misure e finiture su richiesta rivolgersi all'ufficio commerciale.

For the other finishes, please refer to the chart in the fold flap cover.

For customized dimensions and finishes contact FIAM customer service.

DIMENSIONI CUSTOM _ CUSTOM DIMENSIONS

DIMENSIONE BASE BASE DIMENSION	L 140 cm	DIMENSIONE PIANO _ TOP DIMENSION	
		min.	max.
		L 140 cm	200x110 cm
L 170 cm	245x110 cm	300x120 cm	
L 240 cm	310x110 cm	360x120 cm	

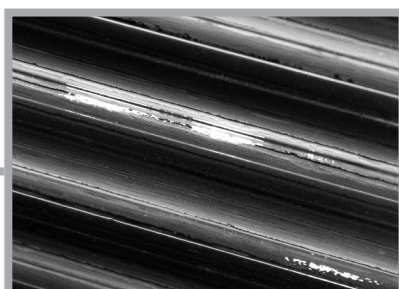

Lievi tracce, avvallamenti superficiali ed irregolarità interne ed esterne alla lastra in vetro sono segni distintivi del processo di fusione ad alta temperatura che ne garantiscono l'artigianalità. Non possono quindi essere oggetto di contestazione.

Slight traces on the surface, perimeter irregularities and small air bubbles in the glass plate are distinctive signs of the high-temperature fusion process that guarantee its craftsmanship. They cannot therefore be contested.

big wave

DESIGN LUDOVICA
+ ROBERTO PALOMBA

modello registrato
registered model

portata sul piano: 150 kg
load capacity on top: 150 kg
art. BW-300, BW-360: 200 kg

Tavolo tondo con base composta da tre o quattro elementi in DV Glass da 30 mm trasparente o a strisce colorate. Piano in vetro da 15 mm trasparente retroverniciato con tinte monocromatiche, oppure ricoperto in Ecomalta, spatolatura tipo fine.

Round table with base made of three or four separate 30 mm DV Glass elements, transparent or with colored stripes. Top made of 15 mm transparent glass, back-lacquered with monochrome color or hand-finished with Ecomalta, finer-grained texture finish.

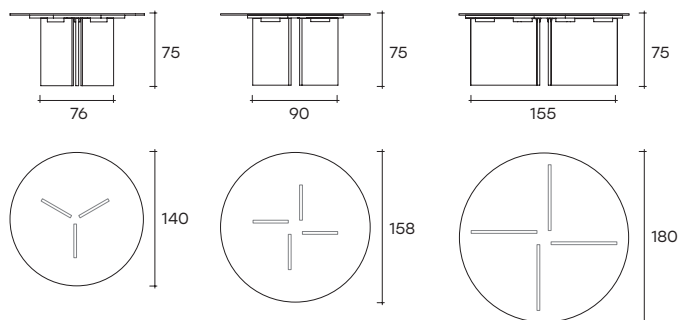

STRUTTURA DV-GLASS® DV-GLASS® STRUCTURE

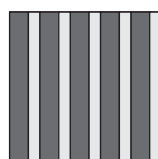
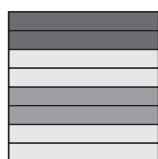
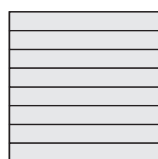

- Trasparente
Transparent
- Fumè
Smoke
- Bronzo
Bronze

Per combinazioni su richiesta,
contattare il customer service.

For customized compositions
please contact Fiam customer service.

dimensioni L, P, H dimensions L, W, H (cm)

	COD./CODE	L	P/W	H	peso netto net weight (kg)	peso lordo gross weight (kg)	volume imballo package volume (m³)
Tavolo con piano in vetro trasparente retroverniciato in tinta Cat.1. Base in DV Glass trasparente. Table with top in transparent glass, back-lacquered - color Cat.1. Base in transparent DV glass.	BW-TRR140 /V-...	Ø140	-	75	99	189	0,68
	BW-TRR158 /V-...	Ø158	-	75	170	237	0,79
	BW-TRR180 /V-...	Ø180	-	75	268	368	1,14
Tavolo con piano in vetro trasparente retroverniciato in tinta Cat.1. Base in DV Glass a strisce colorate. Table with top in transparent glass, back-lacquered - color Cat.1. Base made of colored DV glass.	BW-COR140/V-...	Ø140	-	75	99	189	0,68
	BW-COR158/V-...	Ø158	-	75	170	237	0,79
	BW-COR180/V-...	Ø180	-	75	268	368	1,14
Tavolo con piano in vetro ricoperto in Ecomalta, spatolatura tipo fine. Base in DV Glass trasparente. Table with glass top hand-finished with ecomalta, finer-grained texture finish. Base in transparent DV glass.	BW-TRR140 /ECO-...	Ø140	-	75	100	190	0,68
	BW-TRR158 /ECO-...	Ø158	-	75	170	237	0,79
	BW-TRR180 /ECO-...	Ø180	-	75	270	370	1,14

dimensioni L, P, H dimensions L, W, H (cm)	COD./CODE	L	P/W	H	peso netto net weight (kg)	peso lordo gross weight (kg)	volume imballo package volume (m ³)
Tavolo con piano in vetro ricoperto in Ecomalta, spatolatura tipo fine. Base in DV Glass a strisce colorate. <i>Table with glass top hand-finished with ecomalta, finer-grained texture finish. Base made of colored DV glass.</i>	BW-COR140/ECO-...	Ø140	-	75	100	190	0,68
	BW-COR158/ECO-...	Ø158	-	75	170	237	0,79
	BW-COR180/ECO-...	Ø180	-	75	270	370	1,14

VETRO RETROVERNICIATO _ BACK PAINTED GLASS

CAT. COLORE COLOR CAT.	COLORI COLORS	CODICE _ CODE
		Vetro trasparente _ Transparent glass
CAT.1 Tinta unita Plain color	Grigio grafite Grey graphite	V-GR
	Rosso vinaccia Wine red	V-VI
	Testa di moro Dark brown	V-MR

FINITURE ECOMALTA _ ECOMALTA FINISHES

FINITURE FINISHES	Avorio Ivory	Tortora Dove grey	Nero Ardesia Black slate	Argilla Clay brown	Fango Mud brown	Calce Lime grey
CODICE CODE	TBP	TNR	MNA	MAR	M25	M42

Per altre finiture fare riferimento alla tabella nella bandella di copertina.

Per misure e finiture su richiesta rivolgersi all'ufficio commerciale.

For the other finishes, please refer to the chart in the fold flap cover.

For customized dimensions and finishes contact FIAM customer service.

DIMENSIONI CUSTOM _ CUSTOM DIMENSIONS

		DIMENSIONE PIANO _ TOP DIMENSION	
		min.	max.
DIMENSIONE BASE BASE DIMENSION	L 76 cm	Ø 120 cm	Ø 140 cm
	L 90 cm	Ø 145 cm	Ø 175 cm
	L 155 cm	Ø 180 cm	Ø 220 cm

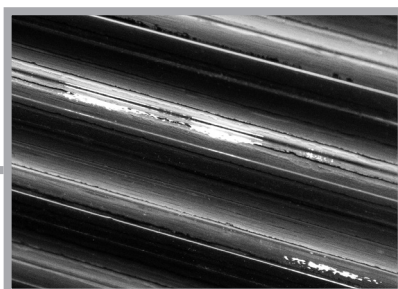

Lievi tracce, avvallamenti superficiali ed irregolarità interne ed esterne alla lastra in vetro sono segni distintivi del processo di fusione ad alta temperatura che ne garantiscono l'artigianalità. Non possono quindi essere oggetto di contestazione.

Slight traces on the surface, perimeter irregularities and small air bubbles in the glass plate are distinctive signs of the high-temperature fusion process that guarantee its craftsmanship. They cannot therefore be contested.