

Libreria HOLLY sp. 3 cm a spalla

nidi

HOLLY bookcase with 3cm-thick load-bearing side panels

LIBRERIA A TERRA

FLOOR STANDING BOOKCASE

Spalla sp. 3 cm
Side panel 3 cm thick

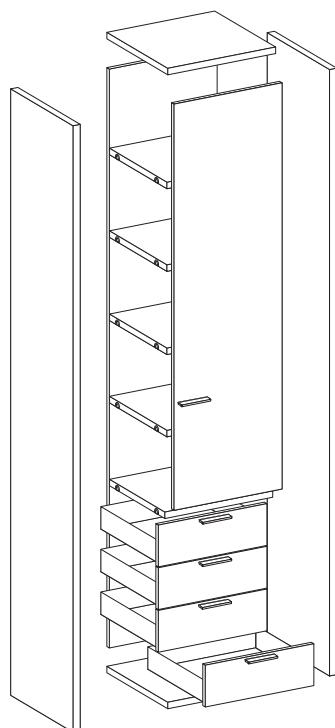
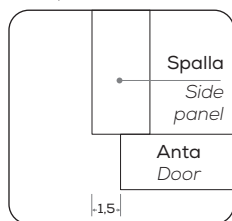

ALTEZZE

HEIGHTS

Altezze comprensive di piedini regolabili H 0,7 cm.

Heights include 0,7cm-high adjustable feet.

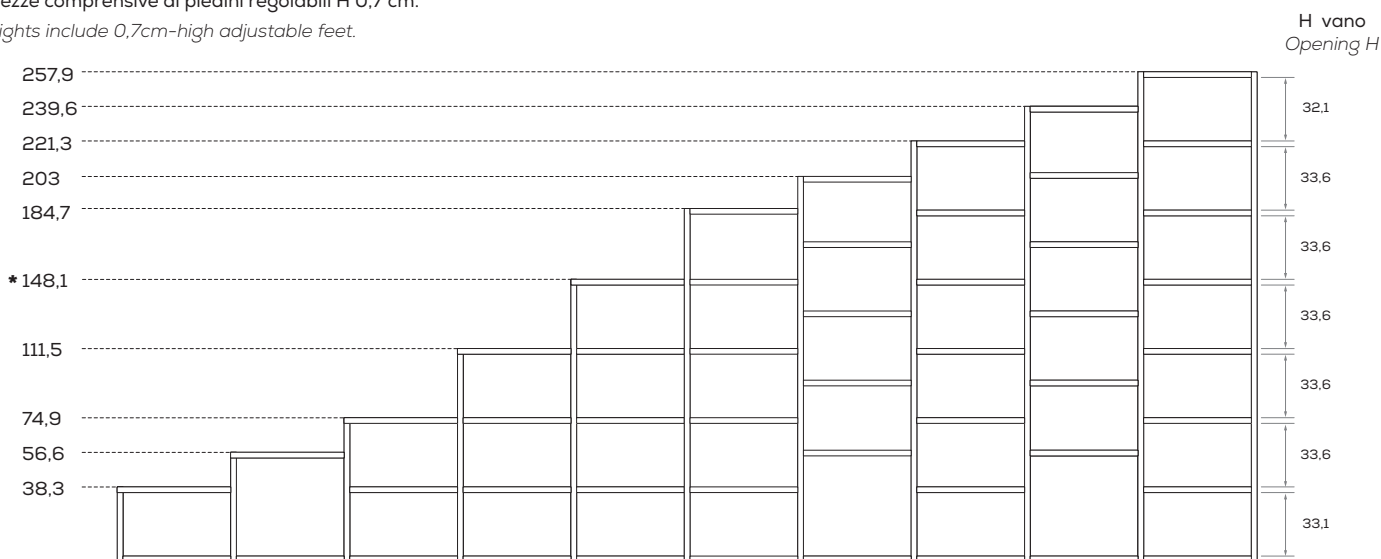

* Il top intero sp. 3 cm, prof. 33 cm, è compreso fino all'altezza 148,1 cm e viene fissato direttamente alle spalle laterali (larghezza massima 300 cm).

The 3cm-thick, 33cm-deep, one-piece top is included up to a height of 148,1 cm and is fastened straight on top of the end side panels (maximum size 300 cm).

LARGHEZZE e PROFONDITÀ

WIDTHS and DEPTHS

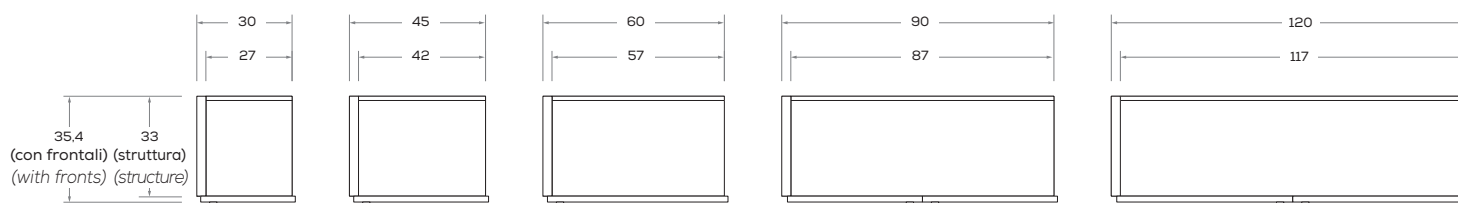

Le informazioni contenute nelle presenti schede tecniche sono indicative. Eventuali differenze con il listino in vigore non costituiscono motivo di contestazione.

The information given in this technical sheet are indicative. Any discrepancies with the price list currently in force cannot be cause for complaint.

Libreria HOLLY sp. 3 cm a spalla

nidi

HOLLY bookcase with 3cm-thick load-bearing side panels

ANGOLI

CORNER UNITS

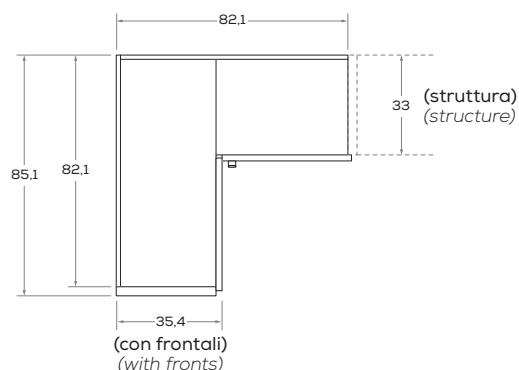

TERMINALI

END UNITS

KAM

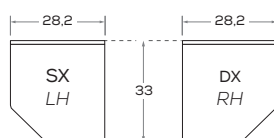

DEN

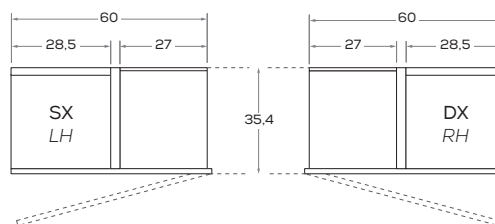

MODULARITÀ ANTE

DOOR SIZE OPTIONS

Anta battente

Hinged door

	Per L / For W 30 cm	Per L / For W 45 cm	Per L / For W 60 cm
H 36,3 cm	<input type="checkbox"/>	<input type="checkbox"/>	<input type="checkbox"/>
H 54,6 cm	<input type="checkbox"/>	<input type="checkbox"/>	<input type="checkbox"/>
H 72,9 cm	<input type="checkbox"/>	<input type="checkbox"/>	<input type="checkbox"/>
H 91,2 cm	<input type="checkbox"/>	<input type="checkbox"/>	<input type="checkbox"/>
H 109,5 cm	<input type="checkbox"/>	<input type="checkbox"/>	<input type="checkbox"/>
H 127,8 cm	<input type="checkbox"/>	<input type="checkbox"/>	<input type="checkbox"/>
H 146,1 cm	<input type="checkbox"/>	<input type="checkbox"/>	<input type="checkbox"/>
H 164,4 cm	<input type="checkbox"/>	<input type="checkbox"/>	<input type="checkbox"/>
H 182,7 cm	<input type="checkbox"/>	<input type="checkbox"/>	<input type="checkbox"/>

	Per L / For W 30 cm	Per L / For W 45 cm	Per L / For W 60 cm
H 201 cm	<input type="checkbox"/>	<input type="checkbox"/>	<input type="checkbox"/>
H 219,3 cm	<input type="checkbox"/>	<input type="checkbox"/>	<input type="checkbox"/>
H 237,6 cm	<input type="checkbox"/>	<input type="checkbox"/>	<input type="checkbox"/>
H 255,9 cm	<input type="checkbox"/>	<input type="checkbox"/>	<input type="checkbox"/>

Anta ribalta / rialza

Pull-down / lift-up door

	Per L / For W 45 cm	Per L / For W 60 cm	Per L / For W 90 cm	Per L / For W 120 cm
H 36,3 cm	<input type="checkbox"/>	<input type="checkbox"/>	<input type="checkbox"/>	<input type="checkbox"/>

Cassetto

Drawer

	Per L / For W 45 cm	Per L / For W 60 cm	Per L / For W 90 cm	Per L / For W 120 cm
H 18 cm	<input type="checkbox"/>	<input type="checkbox"/>	<input type="checkbox"/>	<input type="checkbox"/>

Cassettone

Oversized drawer

	Per L / For W 45 cm	Per L / For W 60 cm	Per L / For W 90 cm	Per L / For W 120 cm
H 36,3 cm	<input type="checkbox"/>	<input type="checkbox"/>	<input type="checkbox"/>	<input type="checkbox"/>

schema modularità ante
fatto da lisa nelle schede
2017.
l'ho riproposto
aggiornandolo con le nuove
misure del listino 2019.

Le informazioni contenute nelle presenti schede tecniche sono indicative. Eventuali differenze con il listino in vigore non costituiscono motivo di contestazione.
The information given in this technical sheet are indicative. Any discrepancies with the price list currently in force cannot be cause for complaint.

Libreria HOLLY sp. 3 cm a spalla

HOLLY bookcase with 3cm-thick load-bearing side panels

nidi

LIBRERIE A PONTE

BRIDGING BOOKCASES

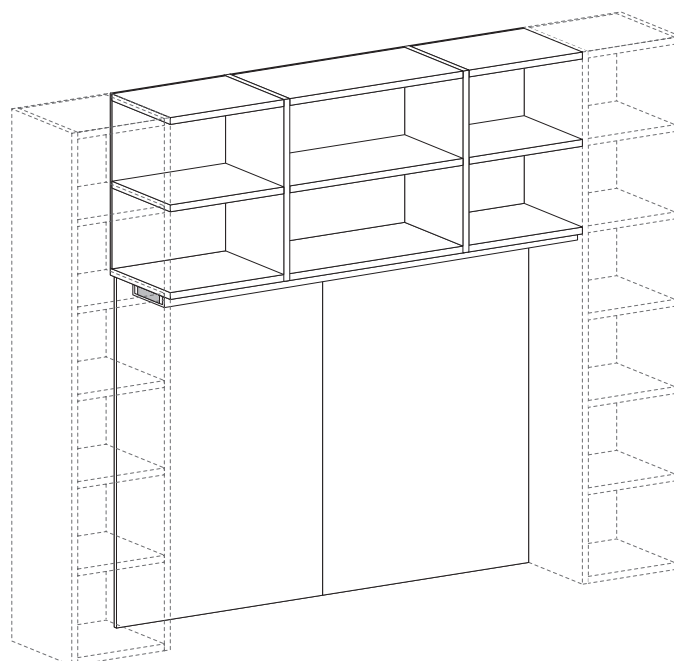

Ponti con pannello sottoponte

Bridging units with panel underneath

I ponti vengono attrezzati con 1 barra ponte.

Bridging units are fitted with 1 bridging unit bar.

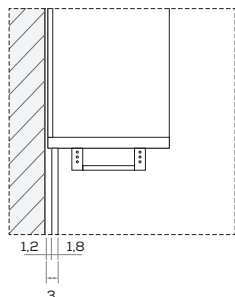
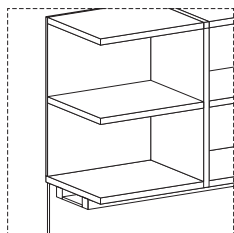

Ponti senza pannello sottoponte

Bridging units with no panel underneath

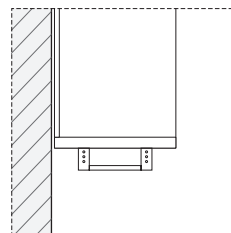

Libreria HOLLY sp. 3 cm a spalla

nidi

HOLLY bookcase with 3cm-thick load-bearing side panels

ALTEZZE

HEIGHTS

H totali
Total H

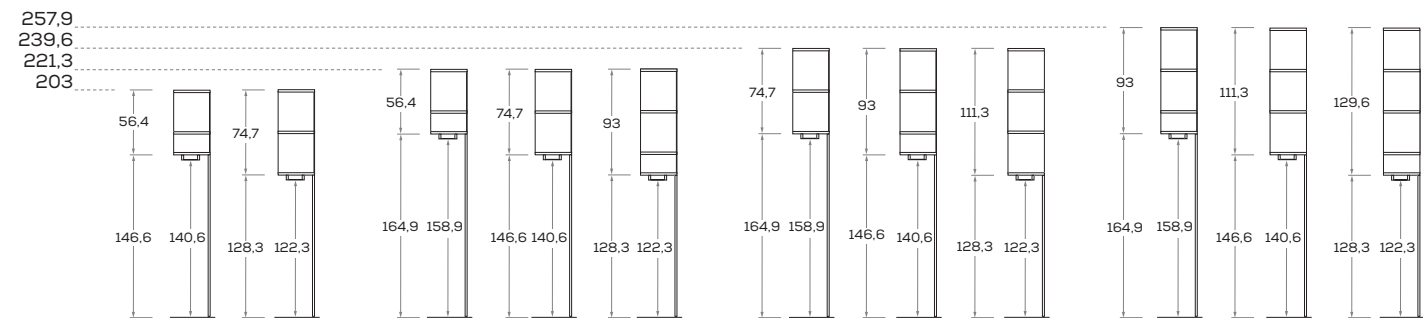

LARGHEZZE

WIDTHS

L / W
cm **135**

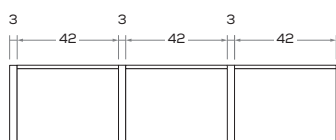

L / W
cm **150**

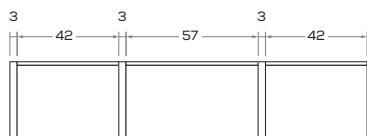

L / W
cm **180**

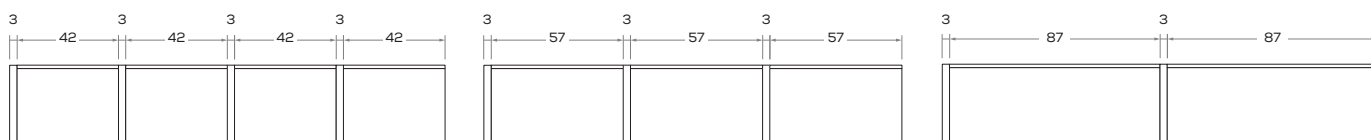

L / W
cm **210**

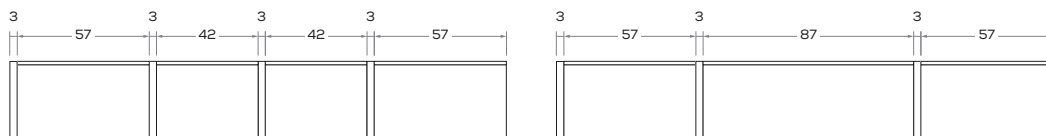

PROFONDITÀ

DEPTHS

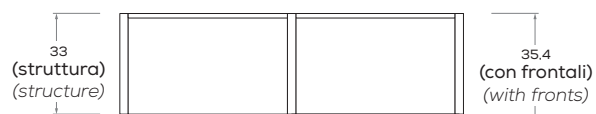

Le informazioni contenute nelle presenti schede tecniche sono indicative. Eventuali differenze con il listino in vigore non costituiscono motivo di contestazione.
The information given in this technical sheet are indicative. Any discrepancies with the price list currently in force cannot be cause for complaint.

Libreria HOLLY sp. 3 cm a spalla

nidi

HOLLY bookcase with 3cm-thick load-bearing side panels

LIBRERIE A SPALLA SOSPESA

WALL-MOUNTED BOOKCASE

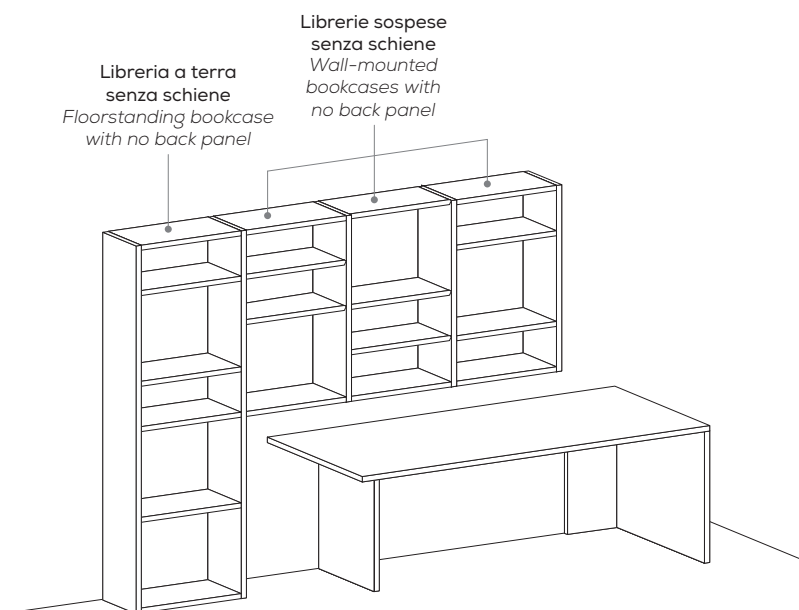
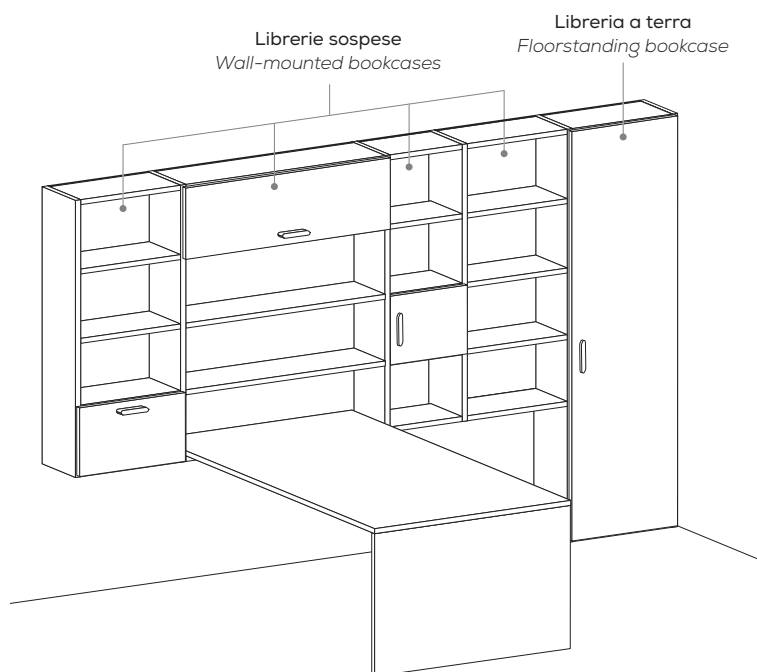

PORTATA MASSIMA PER RIPIANO SP. 3 CM

3CM-THICK SHELF LOAD CAPACITY

	H 38,1	H 56,4	H 74,7	H 111,3	H 147,9	H 184,5
L 30 W	23 kg	23 kg	23 kg	20 kg	20 kg	20 kg
L 45 W	25 kg	25 kg	25 kg	20 kg	20 kg	20 kg
L 60 W	25 kg	25 kg	25 kg	25 kg	20 kg	20 kg
L 90 W	10 kg	10 kg	10 kg	10 kg	10 kg	8 kg
L 120 W	10 kg	10 kg	10 kg	10 kg	10 kg	

Le informazioni contenute nelle presenti schede tecniche sono indicative. Eventuali differenze con il listino in vigore non costituiscono motivo di contestazione.
The information given in this technical sheet are indicative. Any discrepancies with the price list currently in force cannot be cause for complaint.

Libreria HOLLY sp. 3 cm a spalla

HOLLY bookcase with 3cm-thick load-bearing side panels

nidi

ALTEZZE

HEIGHTS

Librerie SOSPESE con CAPPELLO

WALL-MOUNTED bookcases with TOP COVER

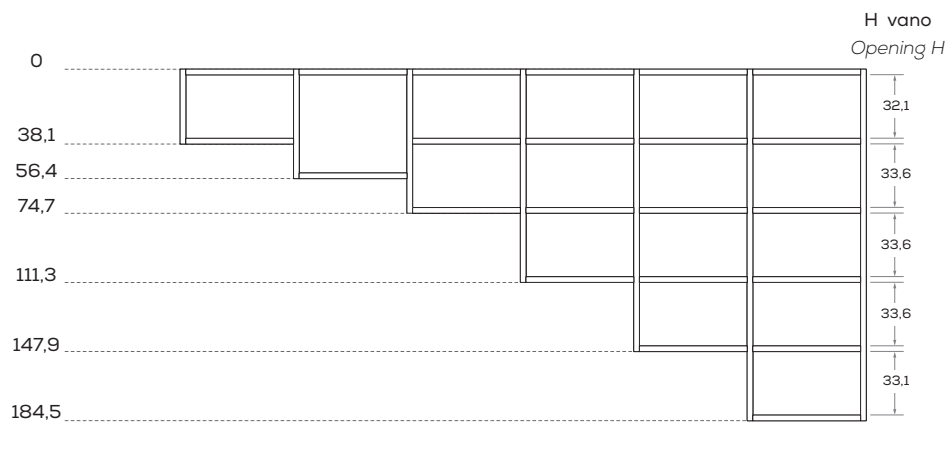

Librerie SOSPESE con TOP INTERO

WALL-MOUNTED bookcases with ONE-PIECE TOP

Il top viene fissato alle spalle laterali.

The top is fastened to the side panels on the ends.

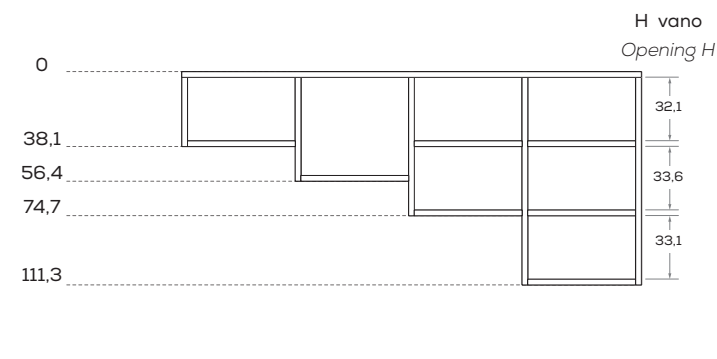

LARGHEZZE

WIDTHS

Le larghezze delle librerie sospese sono comprensive della spalla iniziale sp. 3 cm.

Widths of wall-mounted bookcases include the 3cm-thick side panel at the starting end.



PROFONDITÀ

DEPTHS

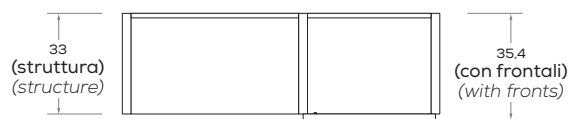

Le informazioni contenute nelle presenti schede tecniche sono indicative. Eventuali differenze con il listino in vigore non costituiscono motivo di contestazione.
The information given in this technical sheet are indicative. Any discrepancies with the price list currently in force cannot be cause for complaint.