

ACOUSTIC & PARTITION

---

COLLABORATIVE  
ROOM

ESTEL









Nell'odierno panorama dell'arredo ufficio la tendenza dominante per la progettazione degli ambienti di lavoro prevede sempre più spesso la presenza di **spazi aperti**, in contrapposizione ad ambienti di lavoro tradizionali chiusi da pareti cieche o vetrate. Nel contempo l'utilizzo di **Scrivanie e Bench fissi o Sit&Stand** è diventata sempre più frequente. L'Open Space semplifica il processo di organizzazione e riduce il costo degli spazi di lavoro, anche se in tali contesti alcuni lavoratori lamentano problemi di concentrazione, carenza di privacy e monotonia dell'ambiente.

Per ovviare a queste problematiche Estel ha sviluppato delle soluzioni in grado di migliorare il benessere di tutti quegli operatori che lavorano in ambienti ad alta densità. In quest'ottica sono stati creati prodotti specifici per **Open Space**, come i divanetti **Dolly Chat**, le **Isole Coffice**, i Tavoli **Banko** e le poltrone **Dolly Eremo**. Inoltre ogni scrivania può essere protetta frontalmente e lateralmente da pannelli schermo fonoassorbenti, contenitori o paretine.

La grande novità è **Collaborative Room**: una soluzione sviluppata da Estel che crea uno spazio nello spazio e che raccoglie e ottimizza 7 tipologie di attività: **Phone Booth, Meeting - Sharing Room, Manager Office, Support Room, Waiting Room e Concentration Room**. Collaborative Room interrompe la ripetitività delle postazioni operative creando "oasi" lavorative di sapore domestico.

Si compone di una gamma di **12 Box modulari**, che varia dal più piccolo B1 (1x1 m) al più grande X2 (5,1x3 m). Collaborative Room è alto 2.4 m ed è disponibile in due varianti di forma: il più elegante ed ergonomico con angoli stondati e il più tradizionale ed economico con angoli retti.

Le performance del **Collaborative Room** garantiscono elevati standard di:

- **Aerazione:** per il controllo CO2, Umidità e Temperatura (monitorabili attraverso una **App per Smartphone e Tablet** collegata ad appositi sensori che permettono il controllo della qualità dell'aria)
- **Illuminazione:** tramite lampade LED con potere diffuso di 500 Lux e una temperatura di colore di 3000 K, collegate tramite connettori in plastica. Su richiesta è possibile integrare un dimmer per regolare l'intensità della luce.
- **Elettrificazione:** l'impianto elettrico che alimenta luci, sensori di presenza e ventilazione è realizzato in bassa tensione (24V - presa di corrente esclusa). Il cablaggio è facilmente realizzabile mediante pratici connettori in plastica.
- **Acustica:** speciali materiali fonoassorbenti e profili sulle porte garantiscono 34 decibel di isolamento acustico.

Nella pagina accanto: **Le 7 attività** di Collaborative Room.

*"Possiamo definire il **Collaborative Room** come il vero protagonista dello **Smart Office del futuro**: uno Spazio flessibile in grado di creare piccole aree riservate da 1 a 12 persone all'interno di ambienti Open Space".*

Alberto Stella, Presidente Estel Group





In today's office furniture design, **open spaces** are largely increasing their presence within working environments, replacing closed spaces or spaces enclosed by solid or glazed walls. At the same time, the use of **fixed** or **Sit&Stand desks and benches** has become more and more frequent. Open Spaces simplify the organization process and reduces costs, although in such contexts some workers may complain of focusing problems, lack of privacy and environment's monotony.

To overcome these problems, Estel develops solutions that improve workers' well-being in highly concentrated workplaces. Every desk can be frontally and laterally protected by soundproofing screen panels, container cabinets or partitioning walls. Specific products have been designed according to Open Spaces needs: **Dolly Chat, Coffice Island, Banko Table and Dolly Eremo Sofa**.

The great innovation is **Collaborative Room**, a room in a room, which collects and optimizes 7 types of activities: **phone booth, meeting - sharing room, manager offices room, support room, waiting room and concentration room**. These solutions interrupt workstations monotony while creating domestic flavored 'work-oases'.

With its variety of **12 modular boxes**, ranging from the smallest B1 (1x1 m) to the largest X2 (5.1x3 m), Collaborative Room is 2.4 m high and available in two different shapes: the elegant and ergonomic rounded-corners version and the affordable and more traditional right-angled version.

**Collaborative Room** features remarkable specifications:

- **Ventilation:** CO<sub>2</sub>, Humidity and Temperature control (monitored through a **smart app** connected to specific sensors that allow air quality control)
- **Lighting:** LED lamps (500 Lux, 3000 K) are easily fixed by means of plastic connectors. Dimmer available upon request.
- **Electrification:** a low voltage system (24V - power sockets excluded) supplies lights, proximity sensors, and ventilation. Cabling is straightforward thanks to practical plastic connectors.
- **Acoustics:** 34 decibels of soundproofing is guaranteed through the use of high-performing materials and specific door profiles.

On the previous page: Collaborative Room's **7 Activities**.

*"Collaborative Room is the protagonist of the future's Smart Office: a flexible space able to create small dedicated areas for up to 12 people in Open Space environments".*

Alberto Stella, President of Estel Group

## Modularità Modularity

Collaborative Room è un prodotto modulare, disponibile in quattro differenti categorie: grazie ad una superficie calpestabile da 2,5 mq fino a 14 mq può ospitare un massimo di 12 persone.

A seconda delle necessità è possibile accessorizzare lo spazio interno con diverse soluzioni di arredo della gamma Estel come tavoli, sedie, poltrone e postazioni video-meeting.

Collaborative Room is a modular product, available in four different categories: thanks to a variety of dimensions, ranging from an area of 2.5 up to 14 square meters, it can accommodate up to 12 people. It is possible to arrange the interior by using products from Estel collections such as tables, chairs, armchairs and video-meeting stations according to client's needs.

## Attività Activities



Sala riunioni - condivisione  
Meeting - Sharing Room



Sala tecnica  
Support Room

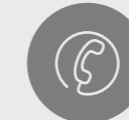

Cabina telefonica  
Phone Booth



Ufficio direzionale  
Office Manager



Coffee - Pranzo  
Coffee - Lunch



Sala attesa  
Waiting Room



Sala Break - Concentrazione  
Break - Concentration Room





Collaborative Room B2 - cabina telefonica per luoghi di lavoro rumorosi.  
B2 Collaborative Room - phone booth for noisy workplaces.



## B2

La versione più piccola del Collaborative Room è disponibile in versione free-standing o modulo a muro (con superficie interna da 0,8 a 1,6 mq). Una soluzione pensata per momenti di focus e concentrazione individuale, telefonate o videochiamate. Può essere accessoriata con un pratico piano di lavoro sospeso elettrificato.

The smallest configuration of the Collaborative Room is available both in free-standing and in wall mounted version (with internal area from 0.8 up to 1.6 sqm). It is a solution designed for moments of individual concentration, phone calls and video calls. It can be equipped with a practical electrified suspended worktop.

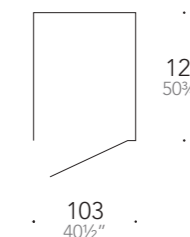





Collaborative Room B2 - cabina telefonica negli uffici open space.  
B2 Collaborative Room - phone booth in open space offices.





XS     

Collaborative Room con angoli arrotondati, di dimensioni contenute, con ampie superfici vetrate o cieche.

Rounded corner Collaborative Room with reduced dimensions, with glazed partitions or solid partitions.

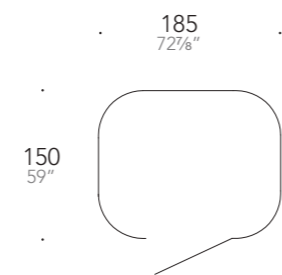

Collaborative Room XS - sala tecnica per fotocopie e stampanti.  
XS Collaborative Room - support room for photocopiers and printers.





Collaborative Room XS - riunione e conversazione.  
XS Collaborative Room - meeting and conversation.



S



Collaborative Room S, con superficie calpestabile di 2,8 mq, è ideale per ospitare mini meeting. Lo spazio interno di questa versione è progettato per accogliere fino a 4 persone e può essere accessorizzato con un piano a parete elettrificato o con un tavolo estensibile.

Collaborative Room S, with a floor area of 2.8 sqm, is ideal for hosting mini-meetings. Interior space of this version is designed to accommodate up to 4 people and can be equipped with a suspended worktop or with an extendible table.

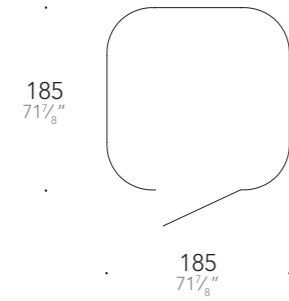

Collaborative Room S - sala riunioni con tavolo estensibile (aperto).  
S Collaborative Room - meeting room with an extendible table (opened).





Collaborative Room S - ideale per la concentrazione. Altri prodotti: poltrona Clarke con pouf e tavolino.  
S Collaborative Room - perfect for concentration Other products: Clarke armchair with pouf and coffee table.





Collaborative Room M - sala riunione. Altri prodotti: tavolo P45, sedie Moi.  
 M Collaborative Room - meeting room. Other products: P45 table, Moi chairs.



M



Collaborative Room M, con ampie vetrate rettilinee e curve e una superficie interna pari a 4,9 mq, può essere utilizzato anche come sala d'attesa.

M Collaborative Room, with wide glazed and upholstered walls and internal surface of 4.9 sqm, can be arranged as waiting room.

239  
94 1/8"

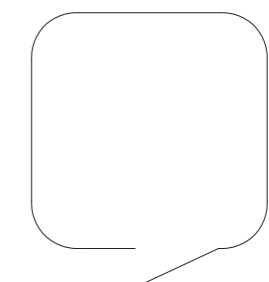

239  
94 1/8"





Collaborative Room M - sala riunione / video meeting. Altri prodotti: Banko P45, sgabello Cono.  
M Collaborative Room - meeting room / video meeting. Other products: Banko P45, Cono stool.





W3



Collaborative Room W è disponibile in tre varianti dimensionali, con superficie interna da 1,7 - 2,2 o 7 mq. Accostato a parete oppure free-standing, è utilizzabile anche come ufficio direzionale.

W Collaborative Room is available in three sizes (1.7 - 2.2 or 7 sqm). Wall mounted or free-standing, can be arranged as Manager Office.

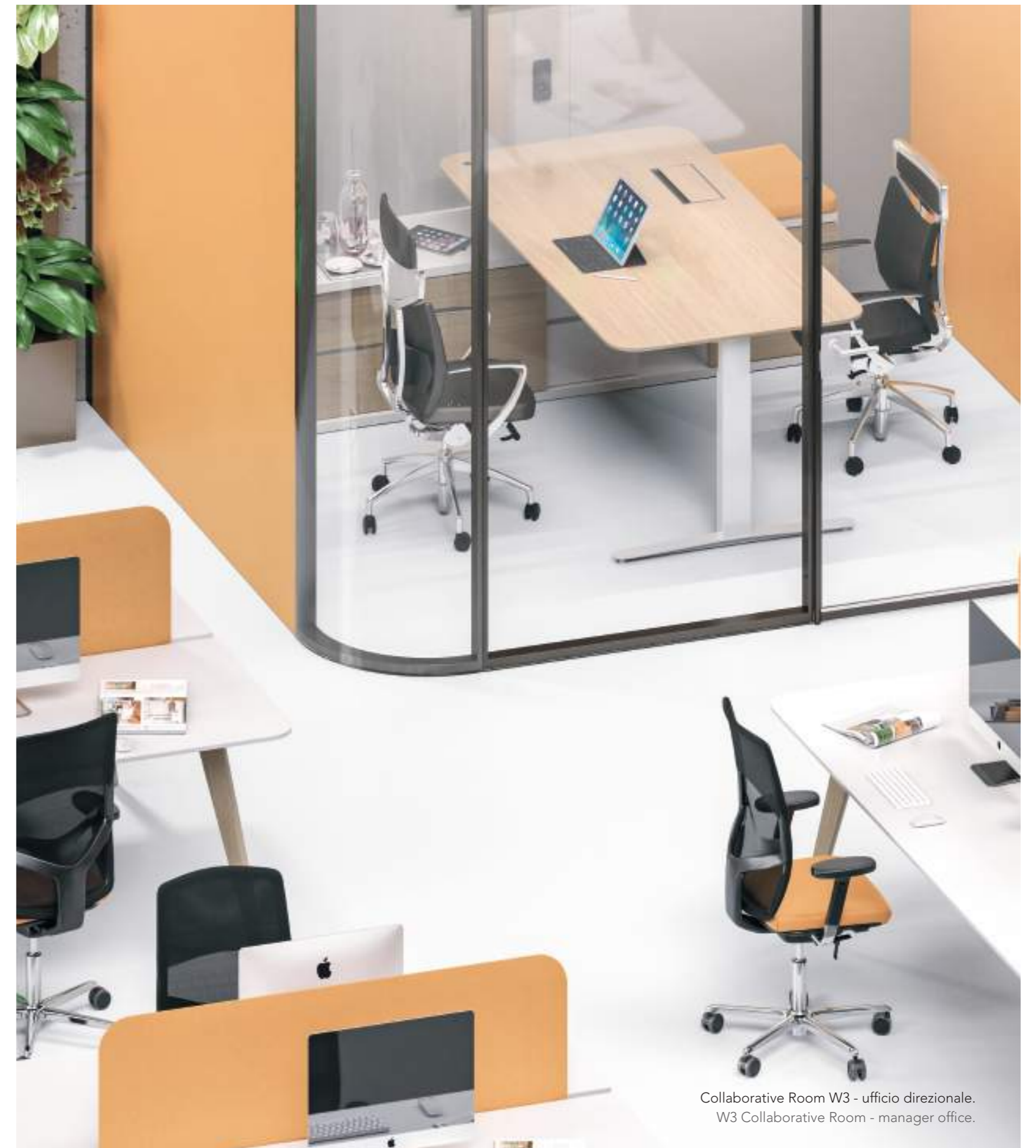
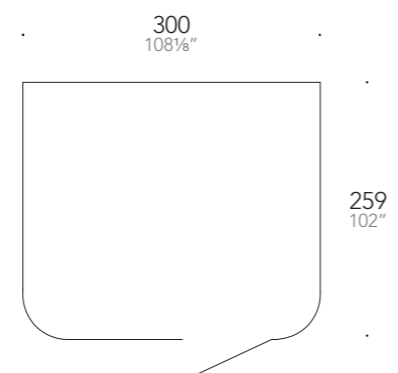

Collaborative Room W3 - ufficio direzionale.  
W3 Collaborative Room - manager office.





Collaborative Room L - Altri prodotti: Isola Coffice.  
 L Collaborative Room - Other products: Coffice island.



Collaborative Room L ha una superficie interna di 8 mq ed è pensato per riunioni o momenti di condivisione.

L Collaborative Room internal surface is 8 sqm; it is arranged for meetings and sharing activities.

300  
118 1/8"

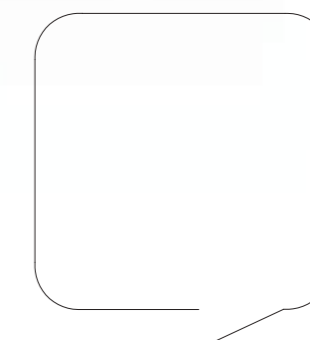

300  
118 1/8"





X



Grazie all'utilizzo di una o più pareti divisorie, Collaborative Room X (con superficie interna calpestabile da 10,6 a 14 mq) può essere configurato in due o più ambienti insonorizzati.

Acoustic partitions can divide X Collaborative Room (with internal area from 10.6 to 14 sqm) into different soundproof spaces.

due ambienti  
con parete  
divisoria

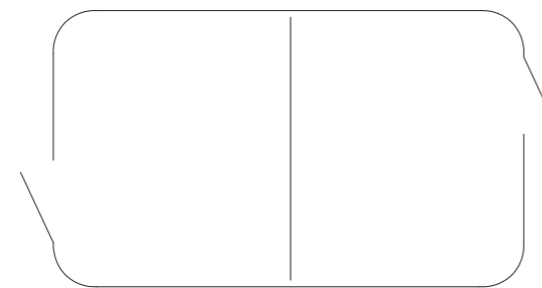

511  
201 1/8"

300  
118 1/8"

monocale  
senza parete  
divisoria



300  
118 1/8"







La possibilità di suddividere Collaborative Room X2 in due differenti aree di lavoro tra loro isolate acusticamente, rispetta i principi dell'activity based working (ABW): ottimizzare gli spazi predisponendo aree dedicate a specifiche attività.

Collaborative Room X2 can be divided into two different soundproof spaces according with activity based working (ABW) theory: to create different work areas assigned to specific activities.





Collaborative Room X3 può essere attrezzato anche come un'unica area, utilizzando elementi della linea Estel Coffice: la soluzione ideale per offrire momenti di relax e condivisione senza allontanarsi dall'ufficio.

Collaborative Room X3 arranged as a unique area with products from Estel Coffice array, allowing to have some rest without exiting the office.



# Ventilazione Ventilation

In tutte le versioni di Collaborative Room il ricambio dell'aria è garantito da un sistema di ventilazione installato a soffitto. Le ventole si attivano automaticamente grazie a sensori di presenza.

Collaborative Room features a ceiling mounted air exchanger. Fans are automatically activated thanks to a detection system.



Il sistema VMC e i relativi condotti sono installati in un apposito vano tecnico posizionato al di sopra del tetto del Collaborative Room, mascherati da un carter in PVC con funzione estetica ed insonorizzante. All'interno del vano è inoltre presente una centralina Wi-fi che, attraverso un software dedicato, consente la gestione remota del sistema di aerazione, attraverso una pratica APP installabile su smartphone e tablet.

Tramite l'APP è possibile:

- accendere/spengere il sistema di ventilazione;
- attivare il funzionamento automatico o manuale;
- visualizzare i dati di analisi dell'aria interna (temperatura, umidità, CO<sub>2</sub>, VOC);
- regolare l'intensità della ventilazione;

All'interno del vano mandata e ripresa dell'aria sono assicurate da griglie installate a soffitto.

VMC system is installed in a technical compartment positioned above the cover of Collaborative Room, masked by a PVC cover with a soundproofing and aesthetical functions. Inside the compartment there is also a wi-fi control unit that, through a dedicated software, allows remote management of the ventilation system thanks to a mobile APP for smartphones and tablets.

Using the APP is possible to:

- switch the ventilation system on/off;
- activate automatic or manual operating;
- analyze internal air data (temperature, humidity, CO<sub>2</sub>, VOC);
- adjust ventilation intensity;

Inside the compartment air supply and return are assured by ventilation grilles installed on the ceiling.



## Acustica Acoustics

Il perimetro di Collaborative Room è costituito da una pannellatura cieca in multistrato di legno, ricoperta da tessuto tecnico con alte caratteristiche di assorbimento acustico, e da moduli in vetro temprato che garantiscono un alto grado di isolamento acustico dall'ambiente esterno.

The perimeter of the Collaborative Room consists of plywood panelling covered by technical fabric with high sound absorption characteristics and tempered glass modules that guarantee a high degree of acoustic insulation from the external environment.

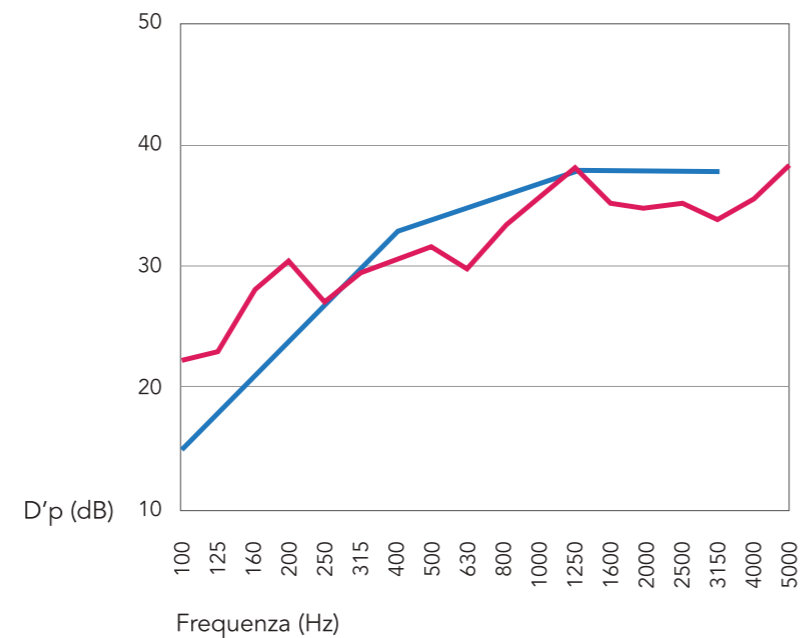

## Elettrificazione Electrification

Tutte le composizioni sono dotate di un pannello interno rimovibile per il cablaggio elettrico. I piani di lavoro sospesi, al pari di tavoli e sedute, sono accessoriabili con punti di accesso all'elettrificazione, usb o ac / dc, per supportare ricarica ed alimentazione. Tutte le versioni di Collaborative Room sono dotate di illuminazione led installata a soffitto: in presenza di persone il sistema di lampade LED con potere diffuso di 500 Lux, si attiva e si spegne grazie ad un sensore di presenza. Su richiesta è possibile anche integrare un Dimmer che regola l'intensità della luce.

All compositions are equipped with a removable internal panel for the passage of electrical wiring. The suspended worktops, as well as tables and chairs, can be equipped with electric access points - USB or AC / DC - for recharging and power supply. All versions of the Collaborative Room are equipped with a LED lighting system installed on the ceiling: the lighting system is automatically activated in presence of people thanks to an electronic access detection system.

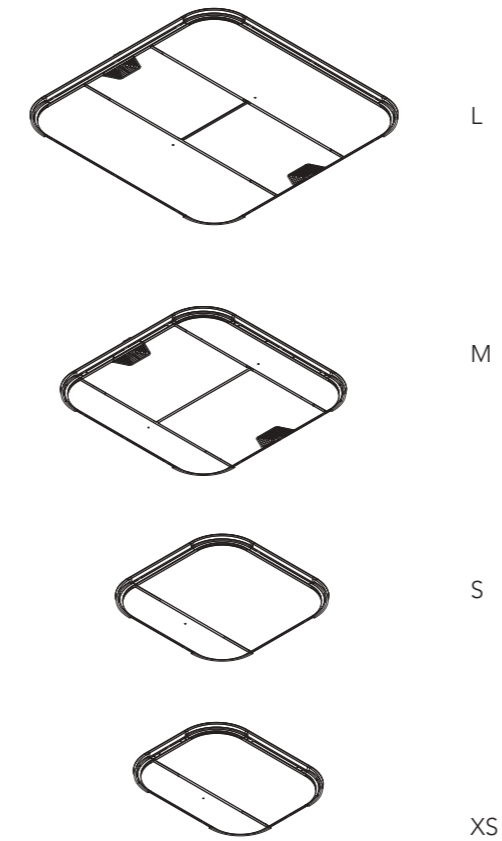





## Componenti Components

### MODULO CIECO UPHOLSTERED MODULE

Modulo cieco esterno/interno rettilineo o curvo, in doppio pannello in multistrato ligneo, rivestito in tessuto tecnico (Smart Office). I tessuti interno ed esterno possono essere diversi, ma devono appartenere alle categorie indicate (non è possibile utilizzare pelli, ecopelli o velluti). I pannelli esterni sono disponibili anche in laccato, e in nobilitato solo nella versione rettilinea.

Upholstered module: straight or curved, double plywood panel (external + internal), upholstered with technical textile (Smart Office). Internal and external textiles can be different, but must belong to the specified categories (use of leather, eco-leather or velvet is not possible). External panels are also available in lacquered finish and in melamine only for the linear version.

### STRUTTURA PORTANTE MAIN STRUCTURE

Strutture portanti in alluminio estruso e/o pressofuso, con parti a vista in finitura verniciata Bianco Neve o Nero Opaco.

Main structure in extruded and/or die cast aluminium, with visible elements in White Snow or Matt Black powder coated finish.

### PORTA CON GHIgliOTTINA DOOR WITH DOOR DROP-DOWN SEAL

Porta ad anta in vetro temperato chiaro sp. mm 10, incernierata, con ghiogliottina (vedi foto a lato), maniglia senza serratura e placca in finitura satinata. Di serie con apertura DX a tirare verso l'esterno. È disponibile anche la versione a passaggio libero (senza porta).

Door: hinged single-pane glass door, th. mm 10, with door drop-down seal at floor (see drawings), door handle without cylinder, plate in satin s/steel finish. Standard opening with right hand pulling. Also available with free doorway versions (no door).

### MODULO VETRATO GLAZED MODULE

Modulo vetrato rettilineo o curvo in vetro chiaro mono-lastra temperato, sp. mm 8, con serigrafia sul bordo in tinta Nero opaco; su tutte le composizioni è presente un pannello tecnico interno (cieco), facilmente rimovibile per la realizzazione del cablaggio elettrico.

Glazed module: straight or curved in clear single-pane tempered glass, th. mm 8, with silk-screen printed perimeter in Matt Black finish.



# Abaco dimensioni

## Dimensions Abacus

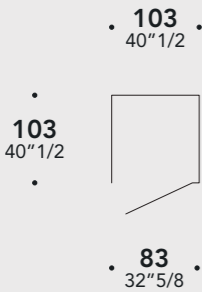

B1

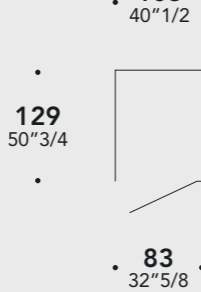

B2

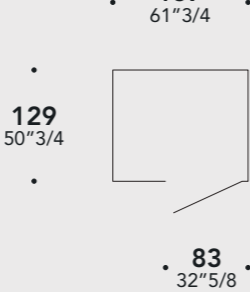

B3

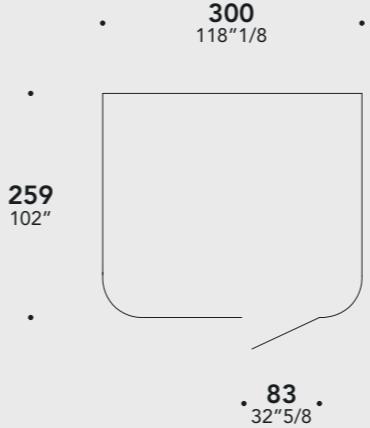

W3

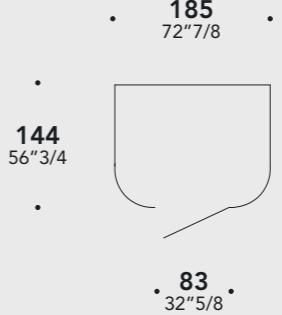

W2

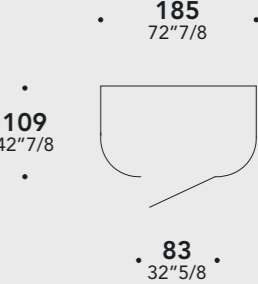

W1

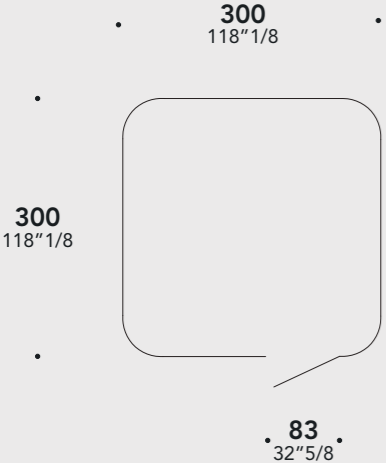

L

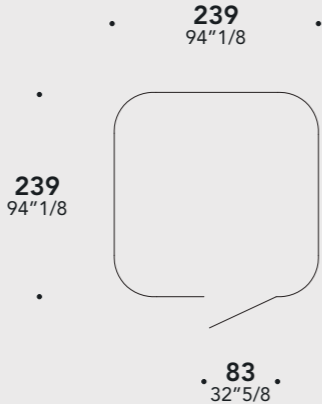

M



S



XS

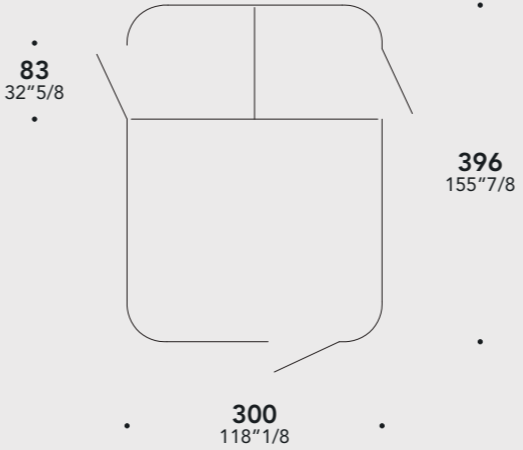

X1

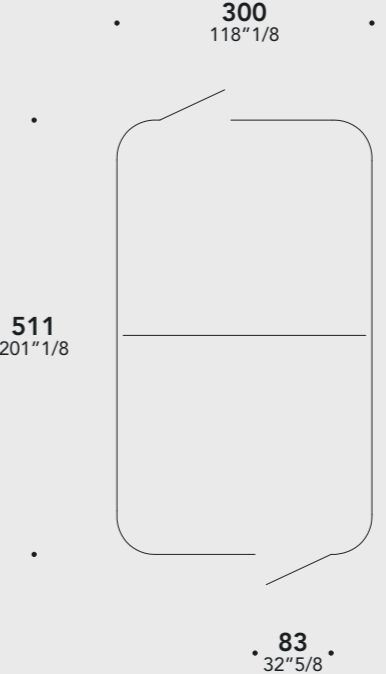

X2

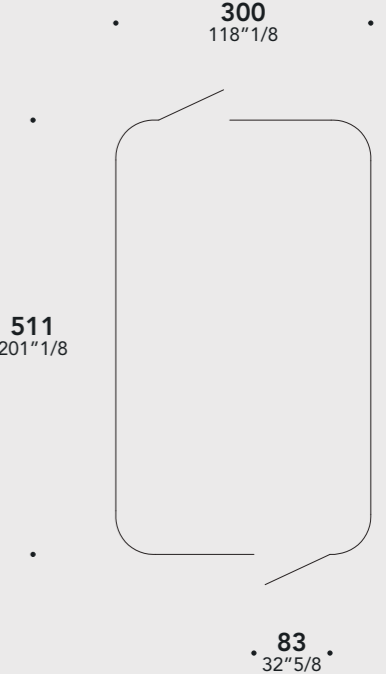

X3



Collaborative Room

Design by METRICA S.r.l.  
[www.metrice-milano.com](http://www.metrice-milano.com)

Product Development by Estel R&D



HEADQUARTER:  
Estel Group srl  
Via Santa Rosa 70  
36016 Thiene (VI) - Italy  
Tel. +39 0445 389611  
Fax +39 0445 808801  
[www.estel.com](http://www.estel.com)

Render & Graphic Design  
Estel Mkt&RD

Print  
Compagnia Nazionale Italiana

January 2019

Estel si riserva il diritto  
di apportare, in qualsiasi  
momento e senza preavviso,  
modifiche necessarie  
dei prodotti illustrati.

Estel reserves the right  
to make any necessary  
changes to the products  
shown at any time without notice.

LCO508





ITALIAN SMART OFFICE

[www.estel.com](http://www.estel.com)

ESTEL

