

Agape bathrooms

/ bagno,
salle de bain,
bad, baño,
浴室.

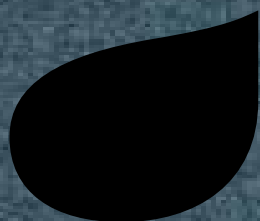

Bathrooms:

Lavabi/Washbasins → pag 007

Sanitari/Sanitary ware → pag 051

Vasche/Bathtubs → pag 057

Docce>Showers → pag 081

Rubinetti/Taps → pag 105

Accessori/Accessories → pag 131

Complementi/Extras → pag 131

Illuminazione/Lighting → pag 131

Specchi/Mirrors → pag 171

Specchi contenitori/Mirror units → pag 171

Contenitori/Storage units → pag 171

Lift Contenitori/Storage units → pag 191

Lato Programma/Programme → pag 195

Ell Piano lavabo/Washbasin countertop → pag 203

DR Piano lavabo/Washbasin countertop → pag 213

Evoluzione Programma/Programme → pag 217

Flat XL Programma/Programme → pag 231

Rigo Programma/Programme → pag 251

**Glossario materiali/Glossary
of materials** → pag 256

Agape factory → pag 258

Agape: una visione evoluta
dell'ambiente bagno.

La storia di Agape inizia nel 1973 e attraversa oltre 40 anni di evoluzione della cultura del progetto, dell'architettura, della tecnologia e dello stile di vita, interpretando uno degli ambienti più speciali della casa: il bagno. Uno spazio che Agape mette al centro della vita domestica, destinato a durare nel tempo ed a donare ogni giorno sensazioni ed emozioni profonde.

La gamma Agape è interamente realizzata in Italia con materie prime di qualità, cura artigianale per i dettagli, processi produttivi efficienti e rispettosi dell'ambiente, come attestato dalla certificazione LEED.

Dai programmi d'arredo ai lavabi, dalle vasche alle soluzioni per lo spazio doccia, dall'illuminazione agli accessori, Agape risolve i diversi aspetti dell'ambiente bagno, con prodotti specifici per le varie esigenze e situazioni.

Entrate anche voi nel mondo Agape, con questo catalogo che vi offre una visione globale di tutti i suoi prodotti, suddivisi per tipologia. Potrete poi approfondire i vari temi, consultando i cataloghi dedicati alle varie famiglie della collezione Agape, che troverete presso il vostro rivenditore oppure sul sito www.agapedesign.it

Agape: the evolution of the
bathroom.

The history of Agape began in 1973 and it has crossed over 40 years of evolution in design, architecture, technology and lifestyle, interpreting one of the most special rooms in the home, the bathroom. A space Agape sets at the heart of domestic life, the bathroom is devised to last through time and to conjure up profound sensations and emotions every day.

The Agape line is made entirely in Italy with high quality raw materials, carefully crafted detail and efficient and environmentally friendly production processes, as confirmed by its LEED certification.

From interior design to washbasins and bathtubs to showers, lighting and accessories, Agape finds a solution for all bathroom scenarios.

Join the world of Agape with this catalogue containing an overview of all our products, grouped by type. You can then explore in greater detail, taking a look at the catalogues specifically dedicated to the various lines in the Agape collection. These are available from your local retailer or at www.agapedesign.it





Bathrooms:

Lavabi/Washbasins

	design Benedini Associati		design Giuseppe Pasquali
pag	027 Block		040 Gabbiano
	032 Carrara		design Shiro Studio
	026 Cheese		/ Andrea Morgante
	037 Cube		020, 021 Nivis
	033 Deep		design Patricia Urquiola
010, 011 Drop			030, 031 Lariana
042 Handwash			017 Pear
028, 029 In-Out			016 Pear C
012 Neb			008, 009 Vieques
036 Normal			design Neri&Hu
034, 035 Novecento XL			014, 015 Immersion
038, 039 Ottocento			design LucidiPevere
023 Ottocento 001			012, 013 Marsiglia
022 Ottocento 002			design Studio MK27, Marcio Kogan,
043 Raso			Mariana Ruzante
025 Spoon			018 DR
024 Spoon XL			design Benedini Associati,
036 661			Andrés Jost, Diego Cisi
041 815			019 EII
	collezione Angelo Mangiarotti		
006, 048, 049 Bjhon 1			
047 Bjhon 2			
045 Lito 1			
046 Lito 2			
044 Lito 3			
	design Fabio Bortolani,		
	Ermanno Righi		
026 Bucatini			



Fez 2
rubinetteria taps

Vieques
lavabo washbasin
— acciaio inox *stainles steel*
P Ø 43,5 × H 19 cm
P Ø 43,5 × H 50 cm



Bucatini
specchio mirror

Sen
rubinetteria taps

Vieques
vasca bathtub

Vieques
lavabo washbasin
— acciaio inox *stainles steel*
P Ø 43,5 × H 90,4 cm



Drop
lavabo *washbasin*
– Cristalplant® biobased
– marmo *marble*
L 67 × P 44,2 × H 18 cm
L 63,3 × P 39,6 × H 18 cm



Drop
lavabo *washbasin*
– Cristalplant® biobased
– marmo *marble*
L 67 × P 44,2 × H 18 cm
L 63,3 × P 39,6 × H 18 cm

Nudo LED
specchio *mirror*



Sen
rubinetteria *taps*
accessori *accessories*



Drop
lavabo *washbasin*
– Cristalplant® biobased
– marmo *marble*
L 67 × P 44,2 × H 85,5 cm



○ **Neb**
lavabo *washbasin*
– Cristalplant® biobased
L 64 × P 42 × H 17 cm

○ **Eli**
programma *programme*

○ **Marsiglia**
lavabo *washbasin*
– Cristalplant® biobased
L 60 × P 47 × H 16 cm

○ **Gemma**
complementi *extras*



○ **Marsiglia**
lavabo *washbasin*
– Cristalplant® biobased
L 60 × P 47 × H 16 cm

○ **Mach 2**
accessori *accessories*

○ **Fez 2**
rubinetteria *taps*

○ **Flat XL**
programma *programme*



Fez 2
rubinetteria taps



Immersion
lavabo washbasin
– Cristalplant® biobased
L 60 × P 40 × H 17 cm



Lato
programma programme



Memory
specchio mirror



Sen
rubinetteria taps
accessori accessories



Immersion
lavabo washbasin
– Cristalplant® biobased
L 60 × P 40 × H 17/90 cm



Dot line
accessori accessories

Minuetto
specchio *mirror*



Pear C
lavabo *washbasin*
— Cristalplant® biobased
— marmo *marble*
L 55,5 x P 40,9 x H 90 cm



Pic-nic
complementi *extras*



4x4
specchio *mirror*



369
accessori *accessories*



Pear
lavabo *washbasin*
— ceramica *ceramic*
L 55 x P 49 x H 18 cm



Pear
lavabo *washbasin*
— Cristalplant® biobased
L 52,7 x P 38 x H 6/16,5 cm

Per maggiori informazioni su DR vedere il capitolo specifico a pag 213
 For more information on DR see the specific chapter on page 213



Per maggiori informazioni su EII vedere il capitolo specifico a pag 203
 For more information on EII see the specific chapter on page 203





4x4
specchi contenitori *mirror units*



Nivis
lavabo *washbasin*
— Cristalplant® biobased
— marmo *marble*
L 60 x P 45 x H 16 cm



Sen
rubinetteria *taps*



Fez 2
rubinetteria *taps*



 **Nivis**
lavabo *washbasin*
— Cristalplant® biobased
— marmo *marble*
L 56,7 x P 39,6 x H 90 cm



○ **Square**
rubinetteria taps

○
Ottocento 002
lavabo washbasin
- marmo *marble*
- Cristalplant® biobased
L 80 x P 38,4 x H 14 cm



○
027
specchi contenitori *mirror units*

○
Ottocento 001
lavabo washbasin
- Cristalplant® biobased
L 60 x P 39,2 x H 14 cm

○
Surf
accessori
accessories

○
Flat XL
programma *programme*

Sen
rubinetteria *taps* / accessori *accessories*



Spoon XL
lavabo *washbasin*
— Cristalplant® biobased
L 63,2 × P 48,2 × H 17,2 cm



Flat XL
programma *programme*



Narciso
specchio *mirror*



Spai
specchio *mirror*



Spoon
lavabo *washbasin*
— Cristalplant® biobased
L 60 × P 45 × H 10/16 cm



Flat XL
programma *programme*



Bucatini
lavabo washbasin
— ceramica ceramic
L 40,5 × P 49 × H 33,5 cm



Fez 2
rubinetteria taps



Cheese
lavabo washbasin
— ceramica ceramic
L 34 × P 36,5 – 40,5 × H 26 cm



Fusilli
specchio mirror



Block
lavabo washbasin
— Cristalplant® biobased
L 60 × P 42 × H 16 cm

In-Out 
lavabo *washbasin*
— Exmar
Ø 48 × H 45 cm





In-Out
lavabo *washbasin*
— Exmar
Ø 48 × H 85 cm



In-Out
lavabo *washbasin*
— Exmar
Ø 48 × H 45 cm



 **Bucatini**
specchio *mirror*

 **Sen**
rubinetteria *taps*
/ accessori *accessories*

 **In-Out**
lavabo *washbasin*
— Exmar
Ø 48 × H 50 cm





○ **Square**
rubinetteria taps

○ **Lariana**
lavabo washbasin
— marmo *marble*
— Cristalplant® biobased
L 64,9 × P 46,9 × H 13 cm

**Lariana lavabi da appoggio /
Over countertop washbasins**

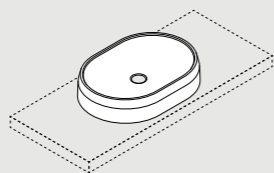
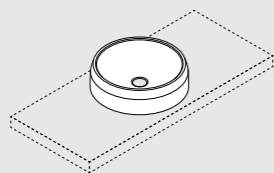

**Lariana lavabo con colonna /
Washbasin with column**

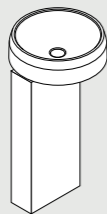

mensola
shelf
L 23 × P 32 cm

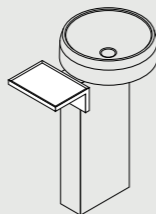

contenitore
storage unit
L 30 × P 41,3 × H 48 cm

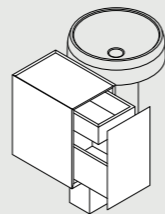

○ **Solid**
specchio *mirror*

Fez 2
rubinetteria *taps*

○ **Constellation**
complementi *extras*



○ **Lariana**
lavabo washbasin
— marmo *marble*
— Cristalplant® biobased
Ø 46,9 × H 13 cm
colonna *column*
— marmo *marble*
— Cristalplant® biobased
L 33 × P 13,5 × H 77 cm



Carrara
lavabo washbasin
— marmo *marble*
L 60 × P 40 × H 16 cm



Memory 2
rubinetteria taps



Deep
lavabo washbasin
— Cristalplant® biobased
L 82 × P 48 × H 18 cm



Memory
specchio *mirror*

Basket
complementi *extras*

Novecento XL
lavabo *washbasin*
— Ceramilux®
L 90 × P 55 × H 13 cm



Memory
specchio *mirror*

Memory 2
rubinetteria *taps*

Novecento XL
lavabo *washbasin*
— Ceramilux®
/ acciaio inox *stainless steel*
L 90 × P 55 × H 85 cm



Evoluzione
programma *programme*



○ **661**
lavabo *washbasin*
— Ceramilux®
L 57,2 × P 44,5 × H 17 cm



○ **Normal**
lavabo *washbasin*
— Cristalplant® biobased
L 64,5 × P 42,5 × H 15 cm



Fusilli
specchio *mirror*



Fez 2
rubinetteria *taps*



Bucatini
accessori *accessories*



Cube
lavabo *washbasin*
— legno *wood*
L 40 × P 40 × H 50 cm



Memory 2
rubinetteria taps

Ottocento
lavabo washbasin
— Cristalplant® biobased
L 70 x P 50 x H 19,6 cm



Memory
specchio mirror

Memory
accessori accessories

Fez 2
rubinetteria taps

Ottocento
lavabo con struttura
washbasin with structure
— Cristalplant® biobased /
acciaio inox stainless steel
L 70 x P 50 x H 85 cm



Gabbiano
specchio *mirror*



Gabbiano
lavabo *washbasin*
— legno *wood*
L 140 × P 48 × H 27,6 cm



Flat XL
programma *programme*



○ **Square**
rubinetteria *taps*



815
lavabo *washbasin*
— marmo *marble*
— Cristalplant® biobased
L 80 × P 42,8 × H 10 cm

Plus ○
contenitore *storage unit*



○ **Fez 2**
rubinetteria taps



○ **Handwash**
lavabo washbasin
— Cristalplant® biobased
L 35 x P 35 x H 15 cm



○ **Spai**
specchio mirror

○ **369**
accessori accessories

○ **Raso**
lavabo washbasin
— Exmar
L 59,8 x P 39,8 x H 16 cm

○ **Flat XL**
programma programme



○
Lito 3
 lavabo washbasin
 — marmo marble
 L 55 x P 40,7 x H 93,1 cm

Bathrooms:
**Collezione lavabi
 Mangiarotti**



A. Mangiarotti

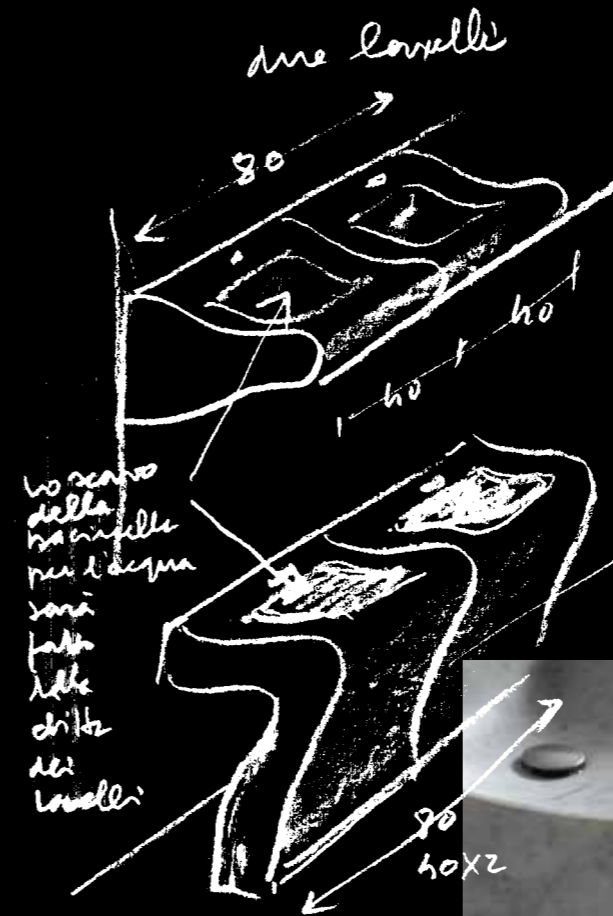

○
Lito 1
 lavabo washbasin
 — marmo marble
 L 55 x P 49 x H 85 cm

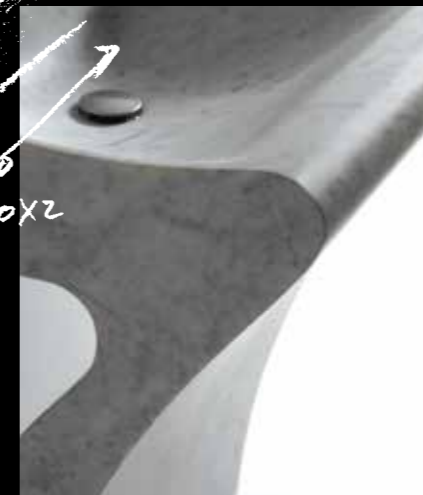



Fez 2
rubinetteria taps



Lito 2
lavabo washbasin
— marmo *marble*
L 40 x P 47,6 x H 91,3 cm



Fez 2
rubinetteria taps



Bjhon 2
lavabo washbasin
— marmo *marble*
— Cristalplant® biobased
Ø 54,5 x H 90 cm



○
DR
vasca *bathtub*

○ **Square**
rubinetteria *taps*

○
Bjhon 1
lavabo *washbasin*
— marmo *marble*
— Cristalplant® *biobased*
Ø 47 × H 19 cm

○
Flat XL
programma *programme*



○
Nudo LED
specchio *mirror*

○
Sen
rubinetteria *taps*

○

○ **Bjhon 1**
lavabo *washbasin*
— marmo *marble*
— Cristalplant® *biobased*
Ø 47 × H 90 cm



Bathrooms:
Sanitari/Sanitary
ware

		design Benedini Associati
pag	052	Memory
	054	750
		design Patricia Urquiola
	053	Pear
	050, 055	Pear 2
		design Benedini Associati, Geberit
	055	Monolith



○ **Memory**
sanitari *sanitary ware*
— ceramica *ceramic*
L 38 × P 55,4 × H 32,8 cm



○ **Square**
comando per WC
control for toilet

○ **369**
accessori *accessories*

○ **Pear**
sanitari *sanitary ware*
— ceramica *ceramic*
L 39 × P 58 × H 25 cm



○ **Flat V**
contenitori *storage units*

○ **Memory**
sanitari *sanitary ware*
— ceramica *ceramic*
L 38 × P 55,4 × H 44,6 cm



750
sanitari *sanitary ware*
— *ceramica ceramic*
L 35,5 × P 57,5 × H 30 cm

Hydro
rubinetteria *taps*



Monolith
modulo per sanitari *module for sanitary ware*
— *legno wood / vetro glass*
L 48 × P 10,7 – 13,7 × H 200 cm



Pear 2
sanitari *sanitary ware*
— *ceramica ceramic*
L 38 × P 52,8 × H 25,5 cm





Bathrooms:

Vasche/Bathtubs

		design Benedini Associati
pag	073	Cartesio
	062	Drop
	068, 069, 070	In-Out
	76	Neb
	058, 059	Normal
	065	Novecento
	056, 066, 067	Ottocento
	066	Ottocento small
	078	Spoon
	077	Spoon M
	079	Spoon XL
	072	Ufo
		design Studio MK27, Marcio Kogan, Mariana Ruzante
	071	DR
		design Patricia Urquiola
	060	Cuna
	061	Lariana
	074, 075	Vieques
	074	Vieques XS
		design Lucidi Pevere
	064	Marsiglia
		design Neri & Hu
	063	Immersion



○ Pic-nic
complementi extras

○
Normal
vasca *bathtub*
— Cristalplant® biobased
L 170,5 × P 72 × H 50,5 cm



Fez 2
rubinetteria taps



Cuna
vasca *bathtub*
— Solid surface
/ acciaio inox *stainless steel*
L 165,5 × P 78,5 × H 51,5 cm



Lariana
vasca *bathtub*
— Cristalplant®
L 168 × P 77 × H 56,3 cm



Fez 2
rubinetteria taps



Gemma
complementi *extras*





Cavalletto
libreria *bookcase*
> Agapecasa

Fez 2
rubinetteria *taps*

Drop
vasca *bathub*
— Cristalplant® biobased
L 195 x P 129 x H 57,5 cm



Fez 2
rubinetteria *taps*

Immersion
vasca *bathub*
— Cristalplant® biobased
L 142,7 x P 70,7 x H 72,5 cm

Ascension
complementi *extras*



Marsiglia
vasca *bath*tub
— Cristalplant® biobased
L 149 × P 87 × H 57,5 cm

Square
rubinetteria *taps*



Memory 2
rubinetteria *taps*

Novecento
vasca *bath*tub
— Cristalplant® biobased
L 180 × 80 × H 51,5 cm



Ottocento small
vasca *bathtub*
— Cristalplant® biobased
L 155 × P 75,5 × H 58 cm

Memory 2
rubinetteria *taps*

Ottocento
vasca *bathtub*
— Cristalplant® biobased
L 178 × P 79 × H 59,5 cm



Memory 2
rubinetteria *taps*

Ottocento
vasca *bathtub*
— Cristalplant® biobased
L 178 × P 79 × H 59,5 cm



○
In-Out
vasca *bathub*
— Exmar
Ø 130 × H 60 cm



○
Eros
tavolino *table*
> Agapecasa

○
In-Out
vasca *bathub*
— Exmar
Ø 130 × H 60 cm

○
Memory 2
rubinetteria *taps*



In-Out
vasca *bathub*
— marmo *marble*
Ø 129,4 × H 59 cm

Memory 2
rubinetteria *taps*

Eros
tavolino *table*
> Agapecasa



DR
vasca *bathub*
— Solid surface / legno *wood*
L 183,5 × P 136,5 × H 56,5 cm

Ted
complementi *extras*

Memory 2
rubinetteria *taps*



Ufo
vasca *bathtub*
— acciaio *steel*
L Ø 204 × H 50 cm

Sen ○
rubinetteria *taps*



Square
rubinetteria *taps*

Pic-nic
complementi *extras*

○
Cartesio
vasca *bathtub*
— Cristalplant®
L 176 – 220 × P 76 – 120
H 55 cm

Tapiro
complementi *extras*



○
Vieques XS
vasca *bathtub*
— acciaio *steel*
L 150 × P 72,6 × H 67,5 cm

○
Vieques
vasca *bathtub*
— acciaio *steel*
L 171 × P 72,6 × H 63,5 cm



Stairs
complementi *extras*



Fez 2
rubinetteria *taps*



○
Vieques
vasca *bathtub*
— acciaio *steel*
L 171 × P 72,6 × H 63,5 cm



Memory 2
rubinetteria taps



Neb
vasca *bathtub*
— Cristalplant® biobased
L 169,8 × P 70 × H 51 cm



Ascension
complementi *extras*



Valet
complementi *extras*



Spoon M
vasca *bathtub*
— Cristalplant®
L 160 × P 85,4 × H 48 cm







Flat D - C5
doccia *shower*



Bathrooms: **Docce / Showers**

Docce / Showers

pag	083, 083	design UT Agape
		Cooper
		design Mario Tessarollo, Giulio Gianurco
	085	Plan-a
	093	design Benedini Associati Flat D
	089, 091, 099	PDX

Cooper
doccia *shower*
— acciaio inox
stainless steel



Sen
rubinetteria *taps*
/accessori *accessories*



Nudo
specchio *mirror*



Woodline
lavabo *washbasin*



Flat D
Piatto doccia *shower*
tray



Vieques
vasca *bathtub*



Cooper
doccia *shower*
— acciaio inox
stainless steel



Bathrooms: Plan-a – Docce / Showers

Docce/Showers

design Mario Tessarollo
Giulio Gianturco

pag	084	Plan-a - A
	089	Plan-a - B
	091	Plan-a - C
	087	Plan-a - D

Docce con pareti in cristallo extrachiaro o fumé sostenute da elementi in alluminio anodizzato spazzolato naturale o nero.

Showers with extraclear or fumé crystal glass walls, supported in natural brushed or black anodized aluminium elements.

Doccia in nicchia /
Niche shower

A

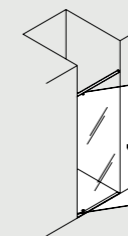

B

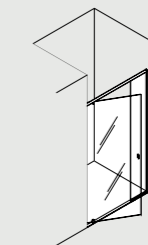

Doccia ad angolo /
Corner shower

C

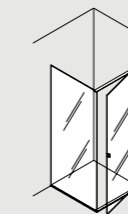

D

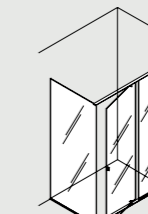

Mach 2
accessori
accessories

369
accessori
accessories

Square
rubinetteria taps

Plan-a - A
doccia shower
— cristallo *crystal glass*
/ alluminio *aluminium*
L 70 - 100 x H 210 cm



Plan-a
 dettaglio cerniera inferiore
 in appoggio su pavimentazione
 continua *detail of lower hinge
 resting on flooring*



Fez 2
 rubinetteria taps



Dot line
 accessori accessoires



Plan-a - D
 doccia shower
 — cristallo crystal glass
 / alluminio aluminium
 L 100 – 200 x P 70 – 140
 x H 210 cm



Plan-a
 dettaglio cerniera superiore
detail of upper hinge



Plan-a
 dettaglio cerniera inferiore
 con guarnizioni *detail of lower
 hing with gaskets*



Sen
 rubinetteria e accessori
taps and accessoires



Plan-a - B
 doccia *shower*
 — cristallo *crystal glass*
 / alluminio *aluminium*
 L 100 – 200 × H 210 cm



PDX
 piatto doccia *shower tray*
 — Ceramilux®
 L 70 – 100 × P 70 – 240 × H 3 cm

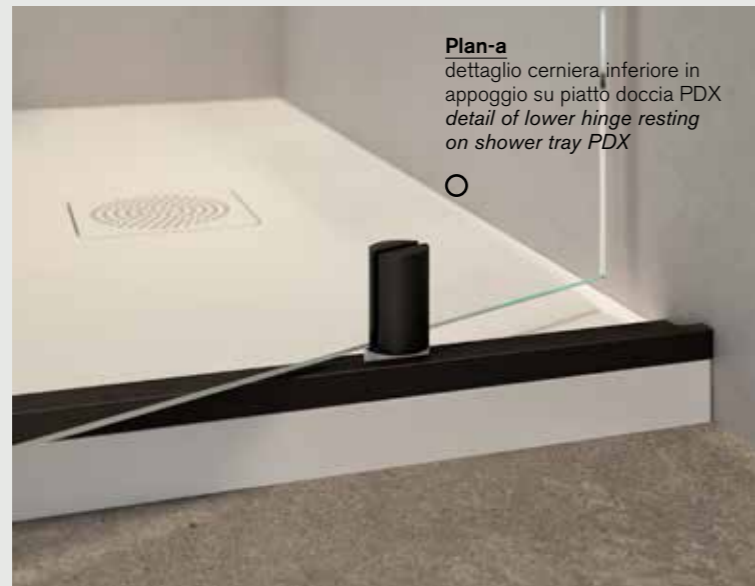



○
Flat D – B1

doccia *shower*
— cristallo *crystal glass*
/ acciaio inox *stainless steel*
L 70 – 100 P 70 – 120
× H 200 cm

Bathrooms:
Flat D – Docce
/ Showers

design Benedini Associati
Flat D

pag	094, 095, 104	Flat D – A2
	092, 101	Flat D – B1
	100	Flat D – XC2
	080	Flat D – C5
	105	Flat D – C6
	103	Flat D – E1
	102	Flat D – XG1
	099	Flat D – XG2



Memory 2
rubinetteria taps



Memory
accessori accessories



Lato
programma programme



Flat D - A2
doccia shower
— cristallo *crystal glass*
/ acciaio inox *stainless steel*
piano calpestio *shower base*
— Exmar
— legno *wood*
L 80 – 100 × P 160 × H 220 cm



Docce con profili in acciaio inox da fissare o incassare a pavimento per il contenimento delle pareti in cristallo e profili verticali da incassare nella muratura.

Showers with stainless steel profiles to fasten to the floor, or recess into the floor, to contain the crystal glass walls, and vertical profiles that must be recessed into the wall.

**Doccia a tre lati /
Three sided shower**

A1
ingresso libero
free entrance

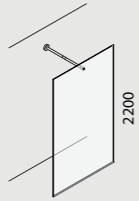

A2
ingresso libero
free entrance

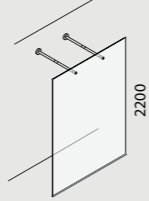

**Doccia ad angolo /
Corner shower**

C1
anta a battente
wing door

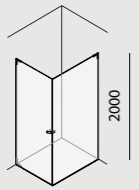

C2
anta a battente
wing door

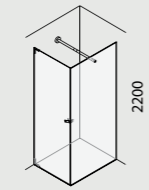

C3
anta a battente
wing door

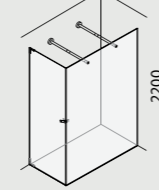

C4
ingresso libero
free entrance

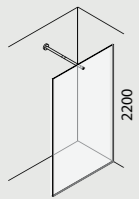

C5
ingresso libero
free entrance

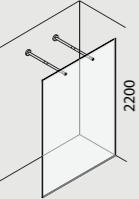

C6
ingresso libero
free entrance



F1
anta scorrevole
sliding door

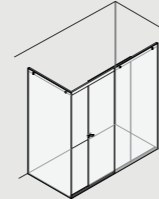

**Doccia in nicchia /
Niche shower**

B1
anta a battente
wing door

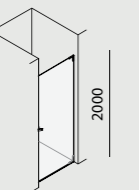

E1
anta scorrevole
sliding door

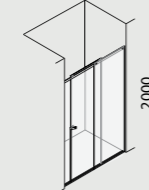

E2
anta scorrevole
sliding door

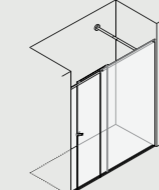

Docce con pareti in cristallo e profili verticali da fissare alla muratura senza bisogno di incasso.

Showers with crystal glass walls and vertical profiles to fasten to the bathroom walls without the necessity of being recessed into the wall.

**Doccia ad angolo /
Corner shower**

XC1
anta a battente
wing door

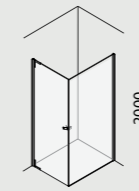

XC2
anta a battente
wing door

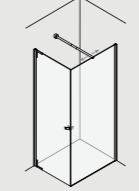

XC3
anta a battente
wing door

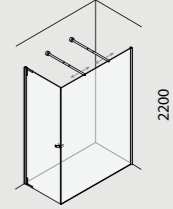

XC4
ingresso libero
free entrance

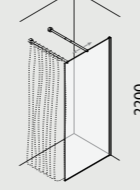

XC5
ingresso libero
free entrance

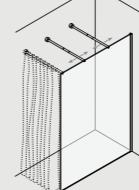

XG1
parete per doccia
shower wall

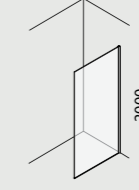

XG2
parete per doccia
shower wall

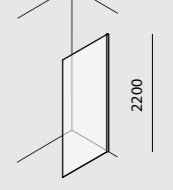

**Doccia in nicchia /
Niche shower**

XB1
anta a battente
wing door

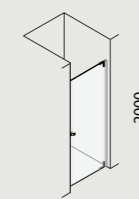

**Piatto doccia /
Shower tray**

PDX

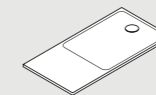



Flat D
 elemento di sostegno
 orizzontale con diffusore
*horizontal support element
 with diffusers*



Flat D - XG2
 doccia *shower*
 — cristallo *crystal glass*
 / acciaio inox *stainless steel*
 L 60 - 95 x H 220 cm



Mach 2
 accessori *accessories*



Fez 2
 rubinetteria *taps*



PDX
 piatto doccia *shower tray*
 — Ceramilux®
 L 70 - 100 x P 70 - 240 x H 3 cm



369
accessori accessories



Flat D - XC2 ○
doccia shower
— cristallo *crystal glass*
/ acciaio inox *stainless steel*
L 70 - 100 x P 70 - 95 x H 220 cm



Fez 2
rubinetteria taps



369
accessori accessories



Flat D - B1 ○
doccia shower
— cristallo *crystal glass*
/ acciaio inox *stainless steel*
L 70 - 100 P 70 - 120
x H 200 cm



Flat D - XG1
 doccia *shower*
 — cristallo *crystal glass*
 / acciaio inox *stainless steel*
 L 60 - 95 x H 200 cm



Memory ○
 sanitari *sanitary ware*



Flat D - E1
 doccia *shower*
 — cristallo *crystal glass*
 / acciaio inox *stainless steel*
 L 120 - 180 x P 80 - 100
 x H 200 cm





Flat D - A2
 doccia *shower*
 — cristallo *crystal glass*
 / acciaio inox *stainless steel*
 piano calpestio *shower base*
 — Exmar
 — legno *wood*
 L 80 - 100 x P 160 x H 220 cm



Fez 2
 rubinetteria *taps*



Flat D - C6
 doccia *shower*
 — cristallo *crystal glass*
 / acciaio inox *stainless steel*
 piano calpestio *shower base*
 — Exmar
 — legno *wood*
 L 80 - 90 x P 160 x H 200 cm



Bathrooms:

Rubinetti/Taps

		design Benedini Associati
pag	106,	Fez 2
	108 – 111	
	112 – 115	Memory 2
	120 – 123	Square
		design Gwenael Nicolas,
		Curiosity
	116 – 119	Sen
		–
		Complementi per rubinetteria
		/Tapware extras
		design Benedini Associati
	127	ARUB 400 / 401
	126	Doccette e soffioni / Handheld showers and shower heads
		design Daniele Borin, Nicola Gibertini, Mattia Vittori
	125	Al dente
		design Giulio Gianturco, UT Agape
	128	Hydro
		design Giulio Gianturco
	124	Kaa



○
Fez 2
 miscelatore con deviatore
mixer with deviator
 — ottone brass



○
Fez 2
 miscelatore per bidet
bidet mixer
 — ottone brass



○
Fez 2
 miscelatore per lavabo
washbasin mixer
 — ottone brass



○
Solid
 specchio *mirror*

○
Fez 2
 miscelatore
 a pavimento per lavabo
*floor standing
 washbasin tap set*
 — ottone brass



○
Bjhn 2
 lavabo *washbasin*

○
Nivis
 lavabo *washbasin*



Fez 2
 bocca di erogazione a pavimento
 per vasca *floor standing bathtub spout*
 — ottone *brass*



Normal
 vasca *bathtub*



Fez 2
 miscelatore con deviatore per
 doccia *mixer with floor deviator*
 for *hand held shower*
 — ottone *brass*



Memory
accessori accessories



Memory 2
gruppo a parete per lavabo
wall mounted washbasin tap
— ottone brass



Surf
accessori accessories

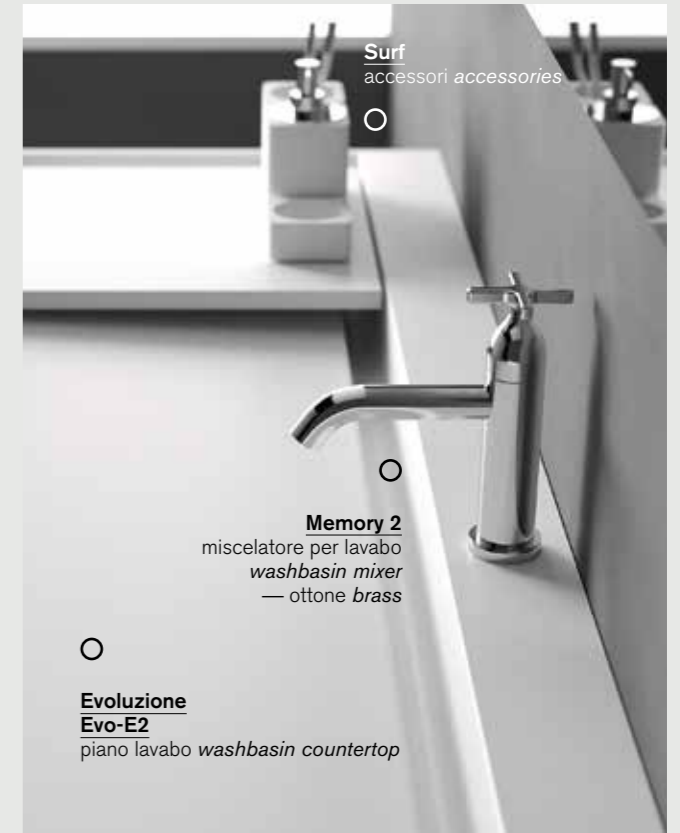

Memory 2
miscelatore per lavabo
washbasin mixer
— ottone brass



Evoluzione
Evo-E2
piano lavabo washbasin countertop

Memory 2
bocca da terra per lavabo
floor standing spout for washbasin
— ottone brass



Memory 2
miscelatore per lavabo
washbasin mixer
— ottone brass





Memory 2
 gruppo per vasca da terra
floor mounted bathtub tap
 — ottone brass



Memory 2
 gruppo monocomando per doccia
 con deviatore e doccia
*mixer tap set for shower with
 floor deviator and handheld shower*
 — ottone brass



Memory 2
 gruppo ad incasso per vasca
built-in bathtub tap set
 — ottone brass



Memory 2
 gruppo per vasca da terra
mounted bathtub tap
 — ottone brass





Sen
 rubinetto a parete per lavabo e accessori
wall mounted washbasin tap and accessories
 — alluminio *aluminium*



Spoon XL
 lavabo *washbasin*



Sen
 miscelatore per lavabo o bidet
mixer for washbasin or bidet
 — alluminio *aluminium*

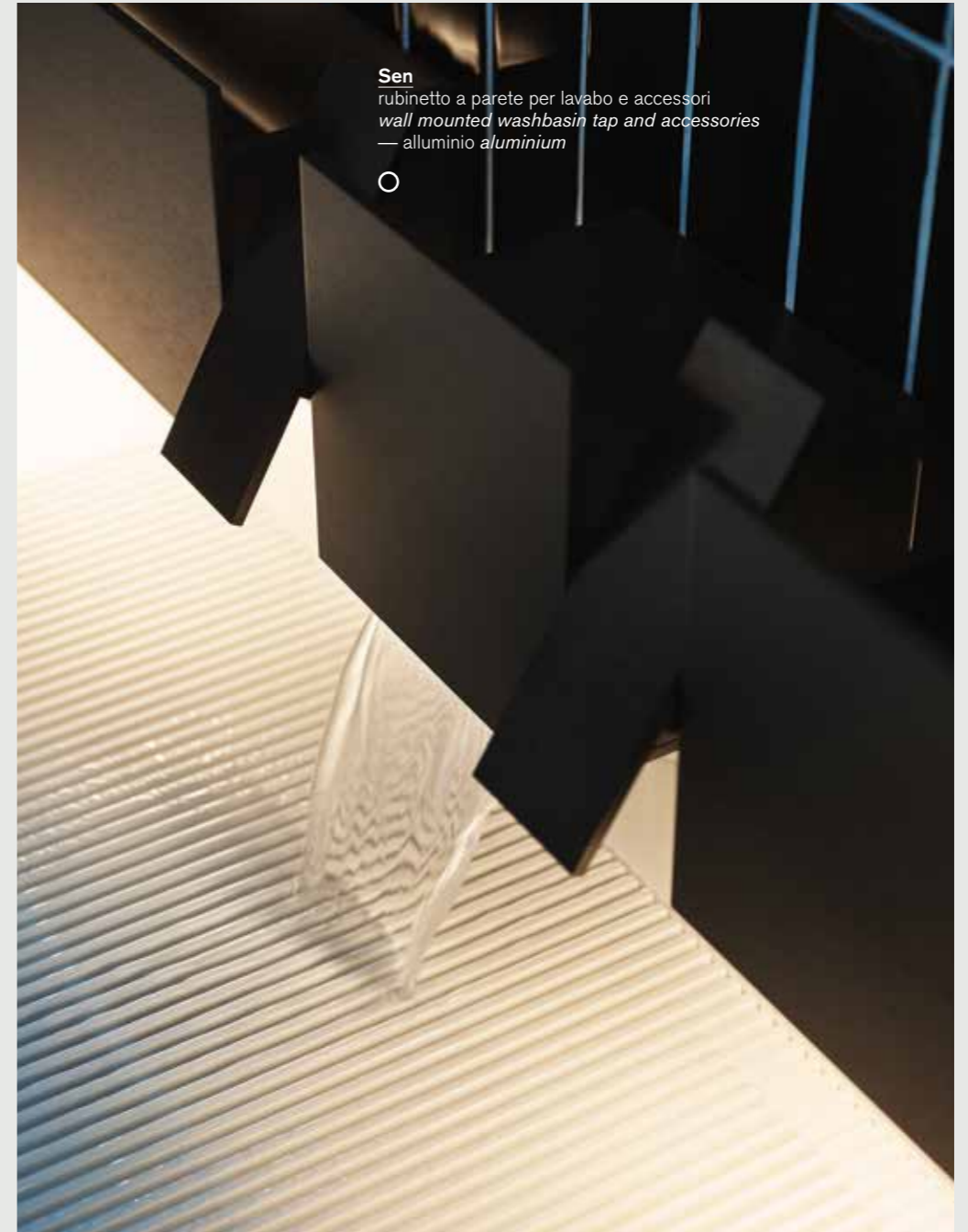

Sen
 rubinetto a parete per lavabo e accessori
wall mounted washbasin tap and accessories
 — alluminio *aluminium*



Sen
miscelatore a pavimento per vasca
floor standing bathtub tap set
— alluminio *aluminium*



Marsiglia
vasca bathtub



Sen
rubinetto per doccia con soffione,
accessori *shower tap with shower*
head, accessories
— alluminio *aluminium*



Sen
soffione a parete
wall mounted shower head
— alluminio *aluminium*



○ **Square**
 gruppo lavabo con bocca
 a parete e miscelatore su piano
*washbasin tap set
 with wall-mounted spout
 and mixer on the top*
 — acciaio inox *stainless steel*



○ **Square**
 gruppo lavabo per piano con bocca e
 miscelatore *top mounted washbasin
 tap set with spout and mixer*
 — acciaio inox *stainless steel*



○ **Square**
 miscelatore per lavabo
washbasin mixer
 — acciaio inox *stainless steel*



○ **Square**
 miscelatore lavabo a parete
wall-mounted washbasin mixer tap
 — acciaio inox *stainless steel*

○ **EII**
 programma *programme*



Square
miscelatore a pavimento per vasca
floor standing bathtub tap set
— acciaio inox *stainless steel*

Marsiglia
vasca *bath tub*



Square
soffione e gruppo termostatico
per doccia *shower head*
and *thermostat unit for shower*
— acciaio inox *stainless steel*



Square
gruppo per bordo vasca
tap set for bath rim
— acciaio inox *stainless steel*



Kaa
soffione doccia *shower head*
— gomma siliconica *silicone rubber*



Kaa
doccetta *hand held shower*
— gomma siliconica
silicone rubber



Al dente
soffione per doccia e portasapone
shower head and soap dish
— polietilene, acciaio inox
polyethylene, stainless steel



supporti e soffioni per doccia
shower heads and supports



supporti e soffioni per doccia
shower heads and supports



ARUB 400 / 401
supporto per soffione doccia
shower head support



Hydro
Idroscopino e idrobidet
Hydrobrush and hydrobidet

○

Finiture per rubinetterie Agape / Finishes for Agape faucets

- di serie / standard
- a richiesta / on request

	Fez 2	Memory 2	Sen *	Square
Ottone cromato Chromed brass	●	●		
Acciaio inox lucido Stainless steel polished finish				●
Acciaio inox satinato Stainless steel satin finish				●
Laccato bianco opaco White matt lacquered	●	○		
Laccato nero opaco Black matt lacquered	●	●		
Alluminio anodizzato nero Black anodised aluminium			●	
Brunito spazzolato Brushed burnished		●		
Gun metal (PVD)				
Copper (PVD)		○		
Nickel (PVD)		○		
Oro satinato Satin gold		○		
Ottone spazzolato Brushed brass		○		
Ottone naturale lucido Natural polished brass		○		

* a richiesta finiture anodizzate: grigio, giallo, verde, blu, rosso, viola, bronzo, naturale
on request anodised finishes: grey, yellow, green, blue, red, purple, bronze, natural



Bathrooms:

Accessori, Comple- menti, Illuminazione /Accessories, Extras, Lighting

	<u>Accessori / Accessories</u>	<u>Complementi / Extras</u>
	design Fabio Bortolani, Ermanno Righi	design Benedini Associati
pag 132 - 135	Bucatini	156 Basket
	design García, Cumini	157 Midi Basket
136 - 139	Dot Line	165 Multifunzione
	design Konstantin Grcic	158 Pic-nic
140 - 143	Mach 2	166 Puzzle
	design Benedini Associati	159 Stairs
130, 144 - 147	Memory	162 Surf
150 - 153	369	164 Valet
154	Surf	166 X
	design Gwenaël Nicolas, Curiosity	design Daniele Dalla Pellegrina
148, 149	Sen	164 Ted
		design Sebastian Herkner
		163 Gemma
		design Alessandro Farnetti
		157 Tapiro
		design Angelo Mangiarotti
		167 Cavalletto
		design Studiopepe
		160 Constellation
		design Neri & Hu
		161 Ascension
		<u>Illuminazione / Lighting</u>
		design Benedini Associati
		168 125 C
		169 369

Bucatini

accessori accessories
 — cavo in acciaio e plastica/ceramica
 stainless steel cable and plastic/ceramic



finiture disponibili *available finishes*
 — ceramica: bianca lucida, nera opaca
 cavetto: trasparente, bianco opaco, nero lucido
 fissaggi: inox lucido, inox spazzolato,
 bianco opaco, nero opaco
ceramic: glossy white, mat black
cable: transparent, mat white, mat black
fixings: polished stainless steel, satin finished
stainless steel, mat white, mat black

Bucatini

accessori accessories
 — cavo in acciaio e plastica/ceramica
 stainless steel cable and plastic/ceramic

○



- 1 specchio *mirror*
- 2 porta abiti *clothes hanger*
- 3 porta salviette *towel holder*
- 4 porta scopino *toilet brush holder*
- 5 porta rotolo *toilet roll holder*
- 6 porta riviste *magazine holder*
- 7 supporto dispenser *support for dispenser*
- 8 contenitore *container*
- 9 porta sapone *soap holder*
- 10 porta spazzolini *toothbrush holder*
- 11 porta rotolo per carta da cucina *kitchen roll holder*
- 12 mensola *shelf*

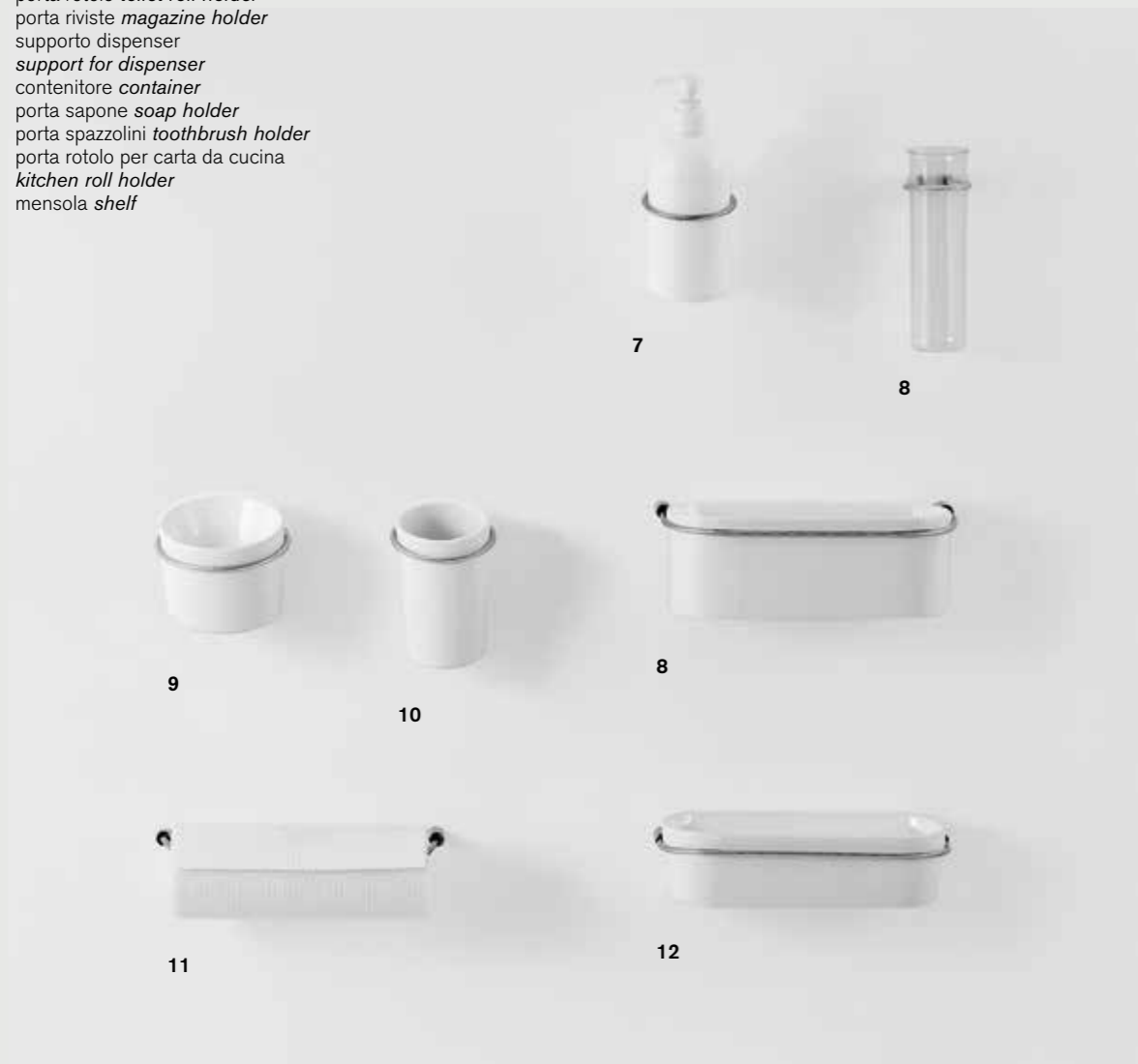

Bucatini
 accessori *accessories*
 — cavo in acciaio e plastica / ceramica
stainless steel cable and plastic / ceramic

Bucatini
 accessori *accessories*
 — cavo in acciaio e plastica / ceramica
stainless steel cable and plastic / ceramic



Dot Line

accessori *accessories*
— alluminio e legno
/ Solid surface e marmo
aluminium and wood
/ *Solid surface and marble*

Dot Line

porta rotolo *toilet roll holder*

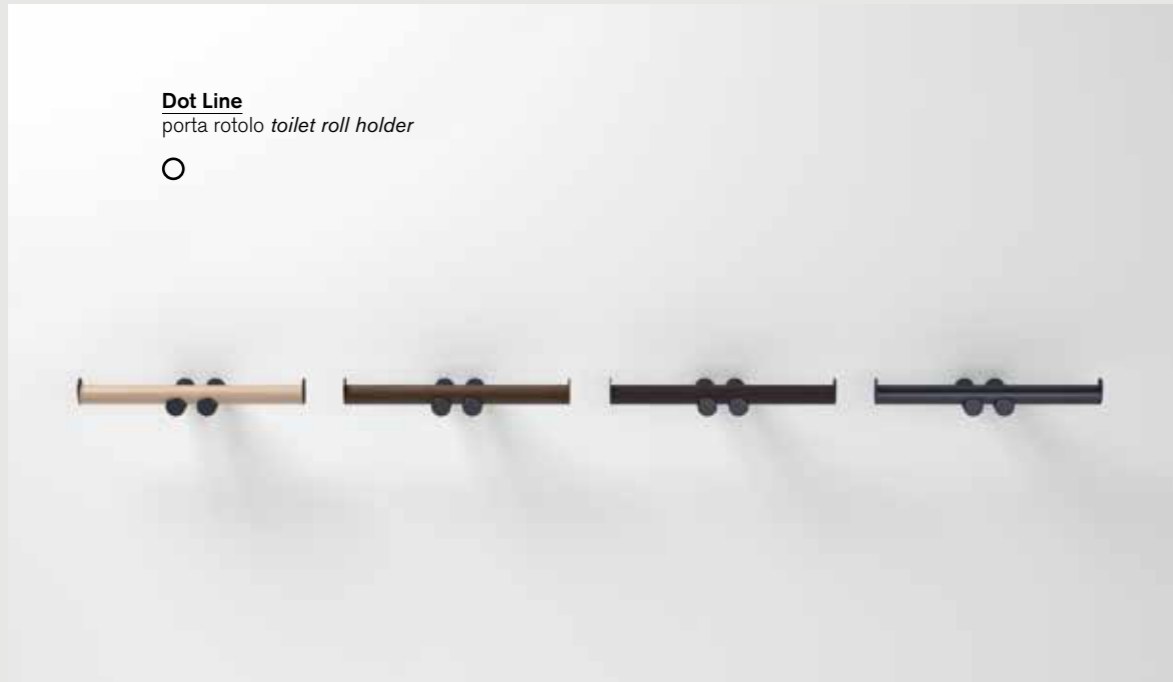

finiture disponibili *available finishes*
— rovere naturale, rovere bruno, rovere scuro,
alluminio anodizzato nero
natural oak, brown oak, dark oak, black
anodized aluminium

Dot Line

accessori *accessories*
— alluminio e legno
/ Solid surface e marmo
aluminium and wood
/ *Solid surface and marble*



- 1 specchio *mirror*
- 2 porta abiti *clothes hanger*
- 3 porta salviette o elemento accessoriabile *towel holder or basic support element*
- 4 porta rotolo *toilet roll holder*
- 5 porta scopino *toilet brush*
- 6 mensola porta sapone e porta spazzolini *shelf soap holder and toothbrush*
- 7 porta rotoli da terra *floor standing toilet paper*
- 8 porta rotolo e porta scopino da terra *floor standing toilet paper and toilet brush*
- 9 porta salviette da terra *floor standing towel holder*
- 10 porta salviette da terra con porta rotolo e porta sapone *loor standing towel holder with toilet roll holder and soap holder*

Dot Line

accessori *accessories*
 — alluminio e legno
 / Solid surface e marmo
aluminium and wood
 / Solid surface and marble



Dot Line

accessori *accessories*
 — alluminio e legno
 / Solid surface e marmo
aluminium and wood
 / Solid surface and marble

- 1 porta abiti *clothes hanger*
- 2 mensole *shelves*
- 3 porta sapone *soap holder*
- 4 porta spazzolini *toothbrush holder*



Mach 2
accessori *accessories*
— acciaio inox *stainless steel*

finiture disponibili *available finishes*
— inox lucido, inox spazzolato, nero
polished stainless steel, stainless steel satin finished, black

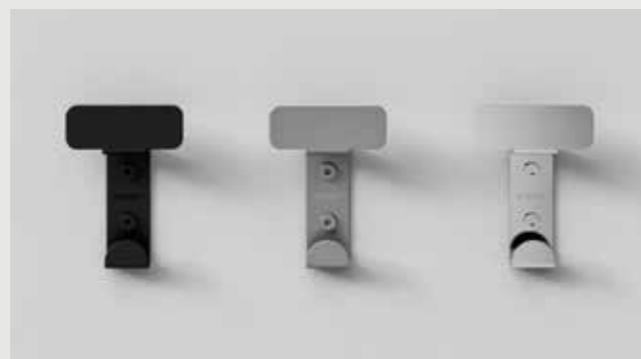

○
Mach 2
accessori *accessories*
— acciaio inox *stainless steel*
/ Solid surface
porta spazzolini,
dispenser sapone liquido
toothbrush holder,
liquid soap dispenser

- 1 porta spazzolini *toothbrush holder*
- 2 dispenser sapone liquido *liquid soap dispense*
- 3 dispenser salviette *paper towel dispenser*
- 4 porta "kleenex" *tissue box holder*
- 5 mensole *shelves*
- 6 gettacarta *wastepaper basket*
- 7 porta sacchetti igienici *sanitary bags dispenser*
- 8 porta rotolo *toilet roll holder*
- 9 porta salviette *towel holder*
- 10 porta scopino *toilet brush holder*

Mach 2
 accessori *accessories*
 — acciaio inox *stainless steel*



Memory

accessori *accessories*
 — acciaio inox *stainless steel*
 / Cristalplant®, marmo *marble*



Memory
 mensola *shelf*



finiture disponibili *available finishes*
 — brunito spazzolato, inox lucido, nero* / Cristalplant®;
 a richiesta, non in figura: ottone spazzolato, bianco,
 gun metal (PVD), copper (PVD), nickel (PVD),
brushed burnished, stainless steel polished, black /*
 Cristalplant®;
 on request, not in picture: brushed brass, white, gun
 metal (PVD), copper (PVD), nickel (PVD)

* non in figura / *not in picture*



Memory

accessori *accessories*
 — acciaio inox *stainless steel*
 / Cristalplant®, marmo *marble*

- 1 specchio *mirror*
- 2 porta abiti *clothes hanger*
- 3 mensole *shelves*
- 4 porta spazzolini *toothbrush holder*
- 5 *holder*
- 6 porta sapone *soap holder*
- 7 porta salviette *towel holder*
- 8 porta rotolo *toilet roll holder*
- 9 porta scopino *toilet brush holder*
- porta salviette da terra *floor standing towel holder*

Memory
 accessori *accessories*
 — acciaio inox *stainless steel*
 / Cristalplant®, marmo *marble*



Memory
 accessori *accessories*
 — acciaio inox *stainless steel*
 / Cristalplant®, marmo *marble*



Sen
accessori *accessories*
— alluminio *aluminium*

- 1 porta abiti *clothes hanger*
- 2 rubinetto per doccia con soffione *shower tap with shower head*
- 3 mensola *shelf*
- 4 porta salviette *towel holder*
- 5 porta rotolo *toilet roll holder*
- 6 porta scopino *toilet brush holder*

finiture disponibili *available finishes*
— anodizzato spazzolato nero;
a richiesta anodizzato spazzolato grigio
(nella foto), giallo, verde, blu, rosso, viola,
bronzo, naturale
black brushed anodised
on request gray (on the picture),
yellow, green, blue, red, purple, bronze,
natural brushed anodised

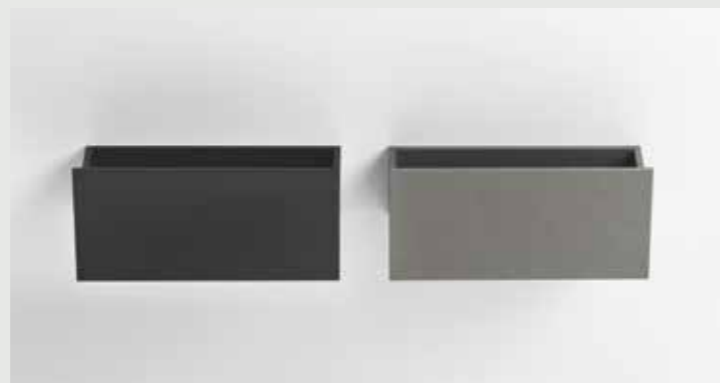

Sen
accessori *accessories*
— alluminio *aluminium*





369 ○
 elemento accessoriabile
 con porta spazzolini o porta
 sapone *basic support*
element with toothbrush
holder or soap holder

finiture disponibili *available finishes*
 — inox lucido, inox spazzolato,
polished stainless steel,
stainless steel satin finished

369
 accessori *accessories*
 — acciaio inox *stainless steel*
 / Cristalplant®



369
 accessori *accessories*
 — acciaio inox *stainless steel*
 / Cristalplant®



- 1 elemento accessoriabile con porta sapone *basic support element with soap holder*
- 2 porta spazzolini *toothbrush holder*
- 3 porta salviette *towel holder*
- 4 elemento accessoriabile con porta sapone e mensola *basic support element with soap holder and shelf*
- 5 elemento accessoriabile o porta salviette *basic support element or towel holder*
- 6 gettacarta waste *paper basket*
- 7 porta scopino, rotolo e sapone *toilet brush holder, toilet roll holder and soap holder*
- 8 dispenser per sapone liquido *dispenser for liquid soap*
- 9 porta sapone *soap holder*
- 10 porta spazzolini *toothbrush holder*
- 11 porta scopino *toilet brush holder*
- 12 porta rotolo *toilet roll holder*

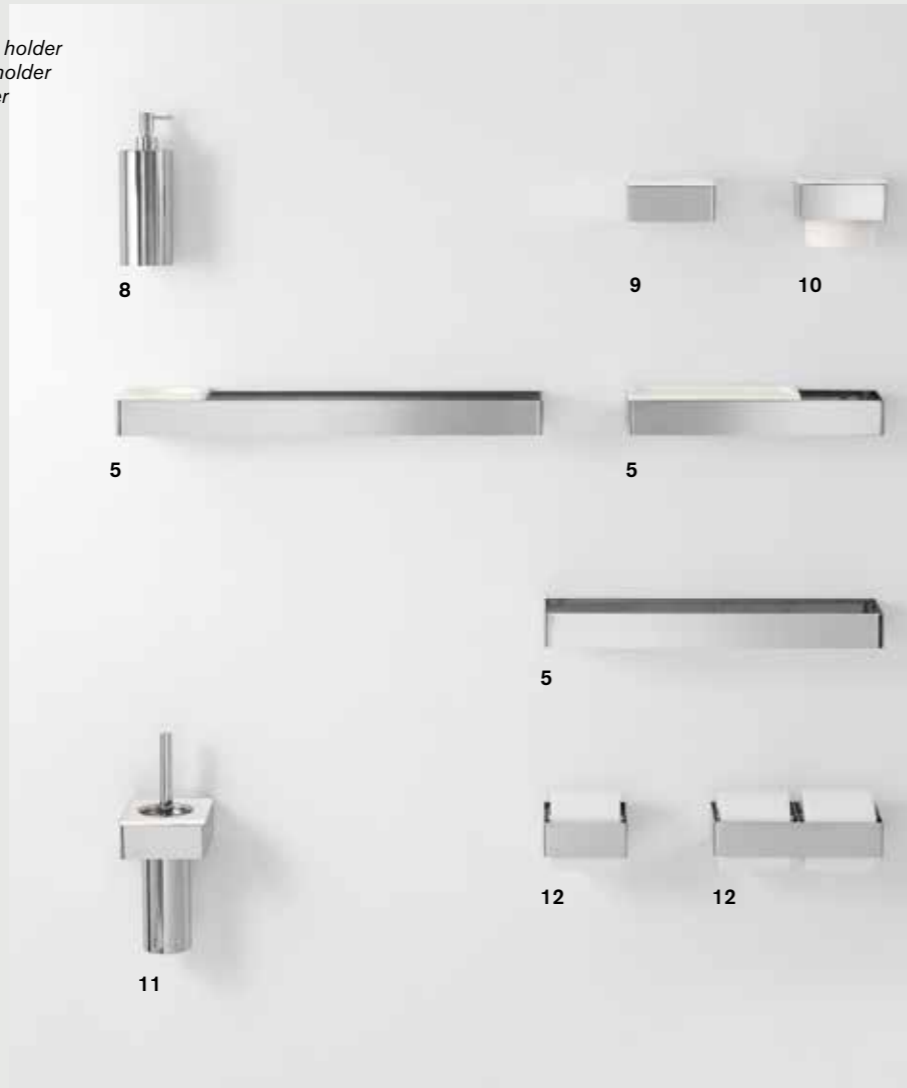

369
accessori *accessories*
— acciaio inox *stainless steel* /
Cristalplant®



369
accessori *accessories*
— acciaio inox *stainless steel* /
Cristalplant®



Surf
accessori accessories
— Cristalplant®



Surf
accessori accessories
— Cristalplant®



Finiture per accessori Agape / Finishes for Agape accessories

- di serie / standard
- a richiesta / on request

	Bucatini	Dot line	Mach 2	Memory	Sen *	369
Acciaio inox lucido Stainless steel polished finish	●		●	●		●
Acciaio inox satinato Stainless steel satin finish	●		●			●
Laccato bianco opaco White matt lacquered	●			○		
Laccato nero opaco Black matt lacquered	●		●	●		
Alluminio anodizzato nero Black anodised aluminium		●			●	
Brunito spazzolato Brushed burnished				○		
Gun metal (PVD)				○		
Copper (PVD)				○		
Nickel (PVD)				○		
Oro satinato Satin gold				○		
Ottone spazzolato Brushed brass				○		
Rovere Oak		●				

* a richiesta finiture anodizzate: grigio, giallo, verde, blu, rosso, viola, bronzo, naturale
on request anodised finishes: grey, yellow, green, blue, red, purple, bronze, natural

Basket
complementi *extras*
— legno *wood*
Ø 40 × H 48 cm



Midi Basket
complementi *extras*
— legno *wood*
Ø 25 × H 30 cm



Tapiro
complementi *extras*
— legno *wood*
L 80 - 110 × P 50 cm





Pic-nic
complementi *extras*
— legno *wood*
L 49 – 63 × P 23 × H 79 cm



Stairs
complementi *extras*
— legno *wood*
L 60 × P 34,5 × H 180 cm





○ **Constellation**
complementi *extras*
— marmo *marble*
/ ottone spazzolato
brush-finish brass



○ **Constellation**
complementi *extras*
— marmo *marble* / ottone spazzolato
brush-finish brass



○ **Immersion**
vasca *bathtub*

○ **Ascension**
complementi *extras*
— legno *wood*
L 60 x P 30 x H 30 cm

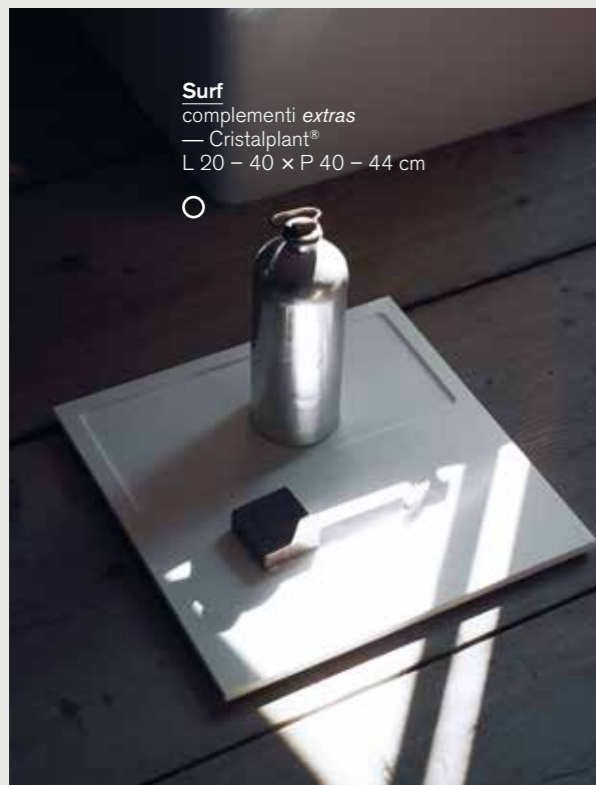

Surf
 complementi *extras*
 — Cristalplant®
 L 20 - 40 x P 40 - 44 cm



Gemma
 complementi *extras*
 — acciaio inox *stainless steel*
 / legno *wood*



Surf
 complementi *extras*
 — marmo *marble*
 L 20 - 40 x P 40 cm



Gemma
 complementi *extras*
 — acciaio inox *stainless steel*
 / legno *wood*
 Ø 34,9 x H 58 cm



Ted
 complementi *extras*
 L 40 x P 26 x H 90 cm
 — Solid surface / acciaio inox
 Solid surface / stainless steel

Valet
 complementi *extras*
 — Cristalplant® biobased / legno
 Cristalplant® biobased / wood
 L 46,6 x P 35,3 x H 77,2 cm



Spoon M
 vasca *bathtub*

Multifunzione
 complementi *extras*
 — Cristalplant® biobased
 L 50 x P 30,5 x H 73,2 cm





X
complementi *extras*
— legno *wood*
L 47,3 × P 40 × H 45,5 – 66,2 cm



Puzzle
accessori per cassetti
accessories for drawers
— legno *wood*



Vieques
vasca bathtub



Cavalletto
complementi *extras*
— legno *wood*
panca *bench*
L 106 - 209 - 312 × P 40 × H 47 cm



125 C
illuminazione *lighting*
— ceramica *ceramic*
Ø 12,5 x P 8,5 cm



369
illuminazione *lighting*
— acciaio inox *stainless steel*
L 24 x P 9 x H 15 cm



Bathrooms:
Specchi, Specchi
contenitori, Conteni-
tori/Mirrors, Mirrors
units, Storage units

	<u>Specchi/Mirrors</u>	<u>Specchi contenitori/Mirrors units</u>
	design Fabio Bortolani, Ermanno Righi	design Benedini Associati
	177 Bucatini	184 027
pag		185 4x4
	design Benedini Associati	
	177 Fusilli	
	179 Insegna	
182, 183	Memory	<u>Contenitori/Storage units</u>
172	Minuetto	design Benedini Associati
174	Narciso	186 Flat XL
180	Parabola	186 Flat V
174, 176	Spai	190 - 193 Lift
172	Spin	186 Monolith
	design UT Agape	189 O.J.C.
	180 Nudo	design Javier Lopez
	181 Nudo LED	187 Plus
	design Giuseppe Pasquali	design Luigi Lanzi
	174 Gabbiano	188 Konte
	design Diego Vencato, Marco Merendi	
170, 178	Solid	
	design Gergely Ágoston, RD Agape	
173	Eclissi	
	design García, Cumini	
179	Dot Line	
	design Studiopepe	
175	Revolving moon	



Minuetto
specchio *mirror*
L 26 x H 40 cm



Spin
specchio *mirror*
L 47 x P 5 x H 44 cm



Eclissi
specchio *mirror*
Ø 70 cm – Ø 50 cm

Bjhon 1
lavabo *washbasin*

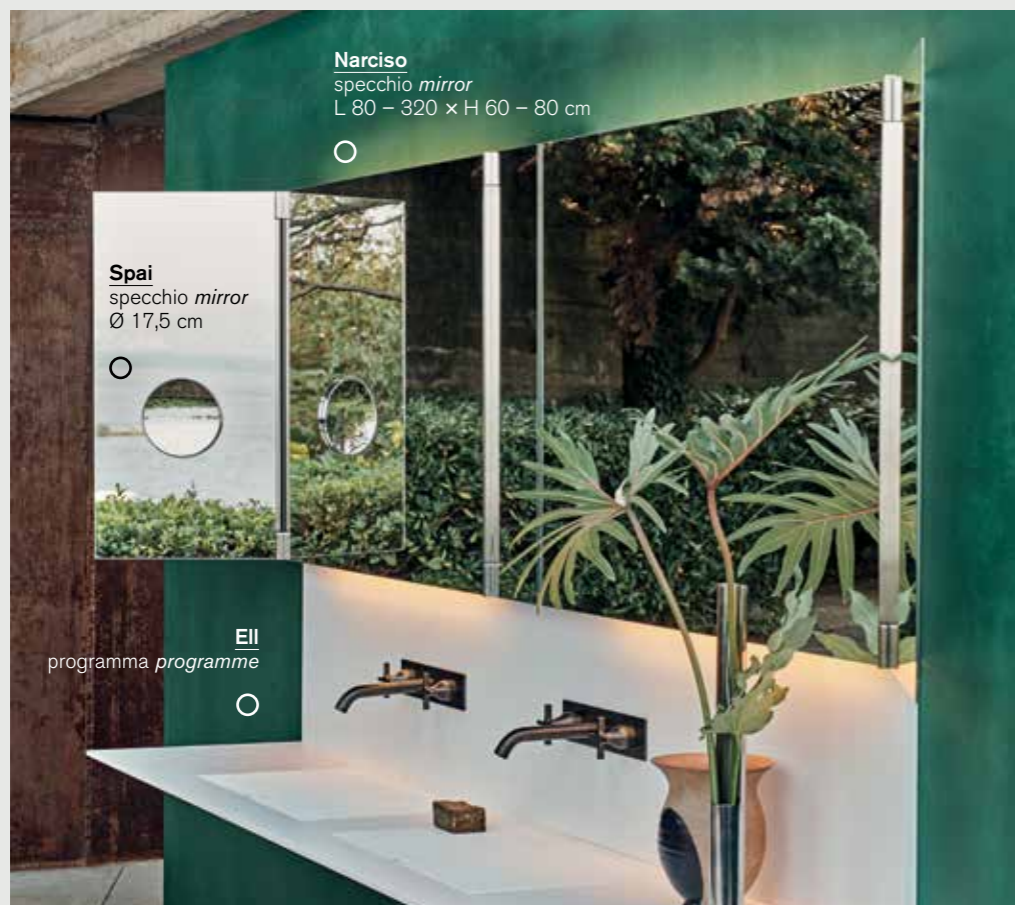



Spai
specchio *mirror*
Ø 17,5 cm



Bucatini
specchio *mirror*
Ø 50 cm



Bucatini
specchio *mirror*
Ø 50 cm



Fusilli
specchio *mirror*
Ø 21 – base *base* L 20 x 20 cm





○ **Solid**
specchio *mirror*
Ø 60,5 cm × P 12 cm

Flat XL Ottocento 001
programma *programme*



○ **Insegna**
specchio *mirror*
L 80 - 120 - 140 - 160 - 180
× H 40 cm



○ **Dot Line**
specchio *mirror*
L 45 × H 80 cm - L 65 × H 110 cm

Parabola
specchio *mirror*
L 80 - 240 x H 48 - 68 x P 6,6 cm
L 48 - 68 x H 80 - 200 x P 6,6 cm



Nudo
specchio *mirror*
L 80 - 240 x H 40 - 60 cm,
L 35 - 80 x H 80 - 120 cm

In-Out
lavabo *washbasin*

Flat XL
programma *programme*



Nudo LED
specchio *mirror*
L 80 - 240 x H 40 - 60 cm
L 35 - 80 x H 80 - 120 cm

Bjhon 1
lavabo *washbasin*

Flat XL
programma *programme*



Memory
specchio *mirror*
Ø 70 - 90 cm



Fez 2
rubinetteria *taps*



Marsiglia
lavabo *washbasin*



Memory
specchio *mirror*
L 70 x H 70 - 100 cm



Memory 2
rubinetteria *taps*



027
specchio contenitore *mirror unit*
— legno *wood*
/ acciaio inox *stainless steel*
L 120,6 – 240,6 × P 16 × H 60 cm



Flat XL
programma *programme*



4x4
specchi contenitori *mirror units*
— alluminio *aluminium*
L 40 – 60 × P 12,5
× H 40 – 60 – 80 – 120 cm



Fez 2
rubinetteria *taps*



Monolith ○
contenitore *storage unit*
— legno *wood*
L 48 × P 13,7 × H 100 cm



Flat V ○
contenitore *storage unit*
— legno *wood*
L 40 × P 25 × H 60 cm



Flat XL ○
contenitore *storage unit*
— legno *wood*
L 40 – 120 × P 42,5 – 50
× H 20 – 40 cm

Nudo ○
specchio *mirror*

Square ○
rubinetteria *taps*

815 ○
lavabo *washbasin*

Plus ○
contenitore *storage unit*
— legno *wood*
L 40 – 100 × P 50 × H 40 cm





○

Konte
contentore *storage unit*
— legno *wood*
L 66 × P 30 × H 196,2 cm



O.J.C.
contentore *storage unit*
— legno *wood*
L 33 × P 33 × H 81,6 cm

○

Contenitori / Storage units

1. Cassa / Casing

altezza / height: cm 60, 80, 100, 120
 profondità / depth: cm 18
 larghezza / length: cm 40
 finiture / finishes: rovere/oak, legno precomposto
 con finitura teak / reconstituted wood, teak finish,
 laccato/lacquered

2 Frontale / Drawer front

altezza / height: cm 60, 80, 100, 120
 larghezza / length: cm 40
 finiture / finishes: rovere / oak, legno
 precomposto con finitura teak / reconstituted
 wood, teak finish, laccato / lacquered, cuoio /
 leather, marmo / marble, specchio / mirror

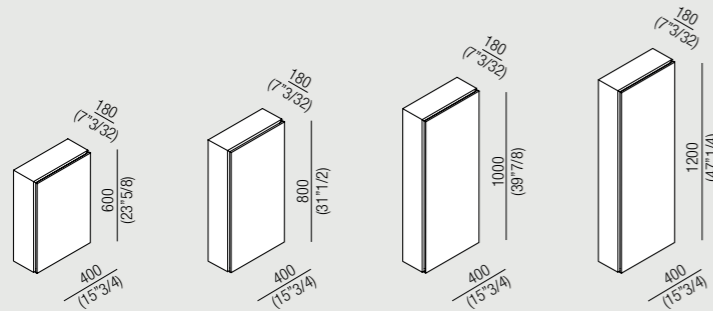

I contenitori possono essere affiancati sia
 in verticale che in orizzontale / The storage
 units can be combined both vertically and
 horizontally

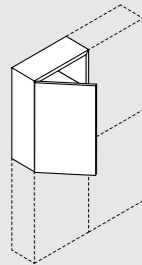

Bathrooms: Lift contenitori / storage units

Lift è un programma di contenitori
 verticali pensili e modulari.

La conformazione della cassa e dell'anta
 permette di accostare i moduli sia in
 direzione verticale che orizzontale
 offrendo una grande flessibilità
 compositiva in fase progettuale.

Il contenitore ha cerniere ammortizzate
 e ripiani interni in vetro fumé.

Con profondità di cm 18 e larghezza di
 cm 40, la cassa è disponibile in quattro
 diverse altezze (60, 80, 100 o 120 cm)
 e 6 differenti finiture.

L'anta, a battente con apertura a destra o
 a sinistra, è personalizzabile in legno,
 marmo, cuoio e vetro.

Con Lift i contenitori Agape si elevano in
 verticale. Grazie alla grande varietà di
 materiali e alla sua elevata modularità, il
 nuovo programma è l'ideale
 complemento ai sistemi Flat XL e Lato.

Lift is a programme of wall-hung and
 modular vertical storage units.

The configuration of the casing and the
 door allows the units to be positioned
 side-by-side, both horizontally and
 vertically, offering a great compositional
 flexibility during the design phase.

The container comes with damped hinges
 and internal shelves in smoked glass.

The casing, which is 18 cm deep and 40
 cm wide, is available in four different
 heights (60, 80, 100 and 120 cm) and 6
 different finishes.

The hinged door, which opens either to
 the right or to the left, is customizable in
 wood, marble, leather and glass.

With Lift, Agape storage units raise
 vertically. Thanks to its wide variety of
 finishes and high modularity, the new
 programme is the ideal complement to
 the Flat XL and Lato systems.



○
Lift
 contenitore *storage unit*
 — legno *wood*
 L 40 x P 18 x H 60 - 80 - 100 - 120 cm



○
Lift
 contenitore *storage unit*
 — legno *wood*
 L 40 x P 18 x H 60 - 80 - 100 - 120 cm



○
Lift
 contenitore *storage unit*
 — legno *wood*
 L 40 x P 18 x H 60 - 80 - 100 - 120 cm



○
In-Out
 vasca *bathtub*

○
Memory 2
 rubinetteria *taps*

Contenitori / Storage units

- Cassa / Casing**
altezza / height: cm 20 o / or cm 40
profondità / depth: cm 47,7
larghezza / length: da / from cm 80 a / to cm 200
finiture / finishes: rovere /oak, legno precomposto
con finitura teak / reconstituted wood, teak finish,
laccato / lacquered
- Cassetto / Drawer**
larghezza / length: cm 40, 60, 80, 100, 120
finiture / finishes: rovere /oak, rovere tinto teak /
oak painted teak
- Frontale / Drawer front**
larghezza / length: cm 40, 60, 80, 100, 120
finiture / finishes: rovere /oak, legno precomposto
con finitura teak / reconstituted wood, teak finish,
laccato / lacquered, cuoio / leather, marmo / marble

- Vano a giorno / Open storage unit**
larghezza / length: da / from cm 21 a / to cm 60
finiture / finishes: rovere / oak, legno precomposto
con finitura teak / reconstituted wood, teak finish
- Vano a giorno sottolavabo /
Open storage unit for countertop basin**
larghezza / length: da / from cm 21 a / to cm 60
finiture / finishes: rovere /oak, legno precomposto
con finitura teak / reconstituted wood, teak finish
- Foro per lavabo da appoggio /
Hole for over countertop washbasin**

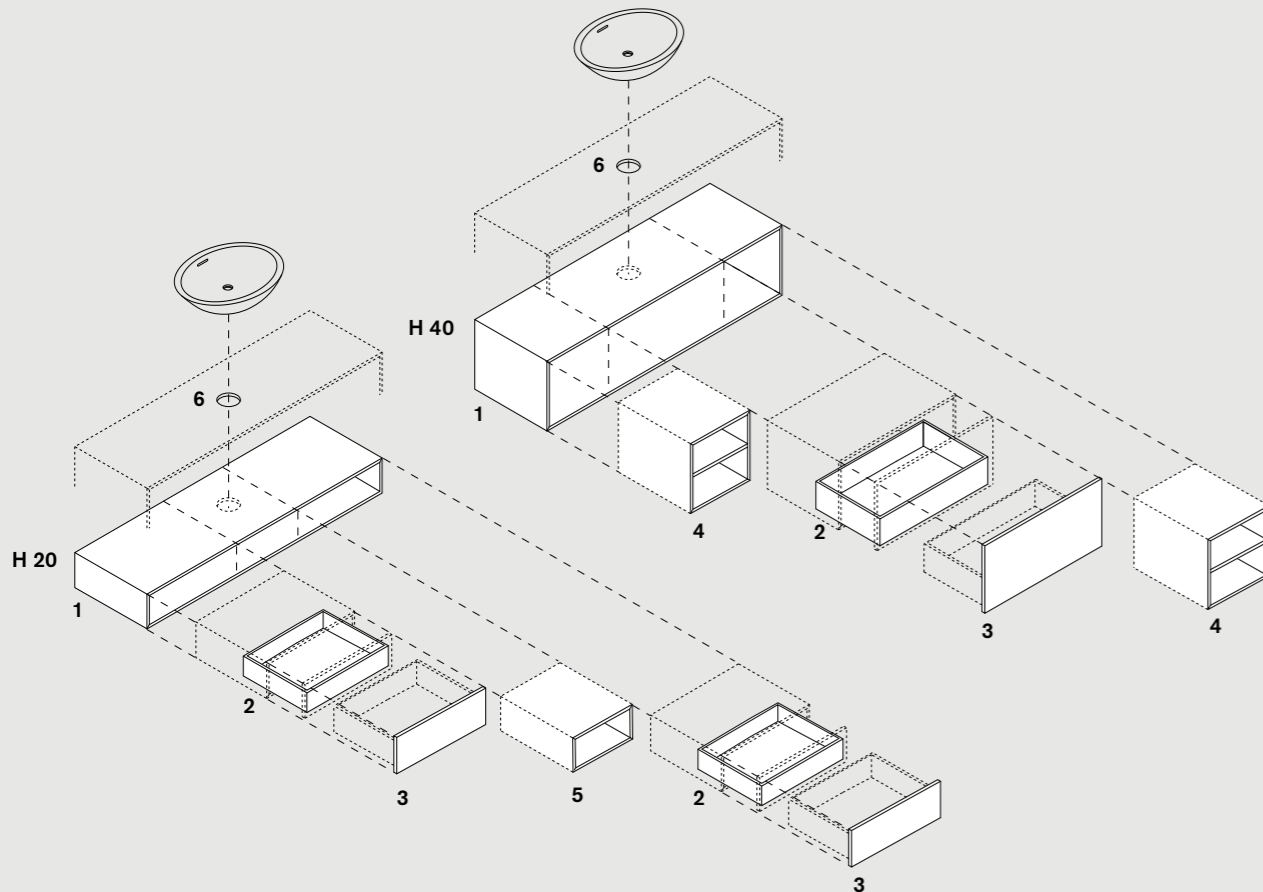

Bathrooms: Lato programma / programme

Disegnato da Benedini Associati, Lato è un programma completo di contenitori che si propone di rappresentare diverse tendenze estetiche, anche innovative o inconsuete, giocando con una molteplicità di finiture sui frontali dei cassetti: dai legni, ai marmi, al cuoio, ai colori laccati. Disponibili con larghezze personalizzabili al centimetro e in due altezze, le casse dei contenitori possono essere a loro volta rivestite in legno in diverse essenze, oppure laccate, in modo da creare una grande varietà di soluzioni. Il programma è pensato per permettere ideali abbinamenti sia con i lavabi in appoggio della collezione Agape, sia con i piani in Corian® o marmo del programma Ell. I cassetti sono dotati di sistema push-pull per l'apertura e la chiusura senza maniglia.

Designed by Benedini Associati, Lato is a complete range of cabinets versatile enough to please all tastes and trends, including the most innovative and original. Drawer fronts come in a variety of finishes: wood, marble, leather, or lacquered and coloured. Customized to the centimetre in width and available in two heights, cabinet drawers can be finished in different woods or lacquered. The system can be paired with countertop washbasins from the Agape collection as well as Corian® or marble Ell countertops. The drawers work on a push-pull system for opening and closing without handles.

Nudo LED
specchio *mirror*



Square
rubinetteria *taps*



Drop
lavabo *washbasin*



Spai
specchio *mirror*



369
accessori *accessories*



Lato
programma *programme*
L 160 x H 40 cm



Solid
specchio *mirror*



Evo - E2
piano lavabo *washbasin countertop*



Lato
programma *programme*
L 200 x H 40 cm

EII
piano lavabo *washbasin countertop*



Lato
programma *programme*
L 200 x H 20 cm





○
Lato
programma *programme*
H 20 cm



○
Lato
programma *programme*
H 20 cm

Piano lavabo Wasbasin countertop

1. Piano/lavabo in appoggio su contenitori Lato
Top/washbasin in support on the containers Lato
2. Piano/lavabo autoportante
Self-bearing top/washbasin
3. Invaso / Recess
4. Griglia / Grill
5. Lavabo / Washbasin
6. Struttura / Structure

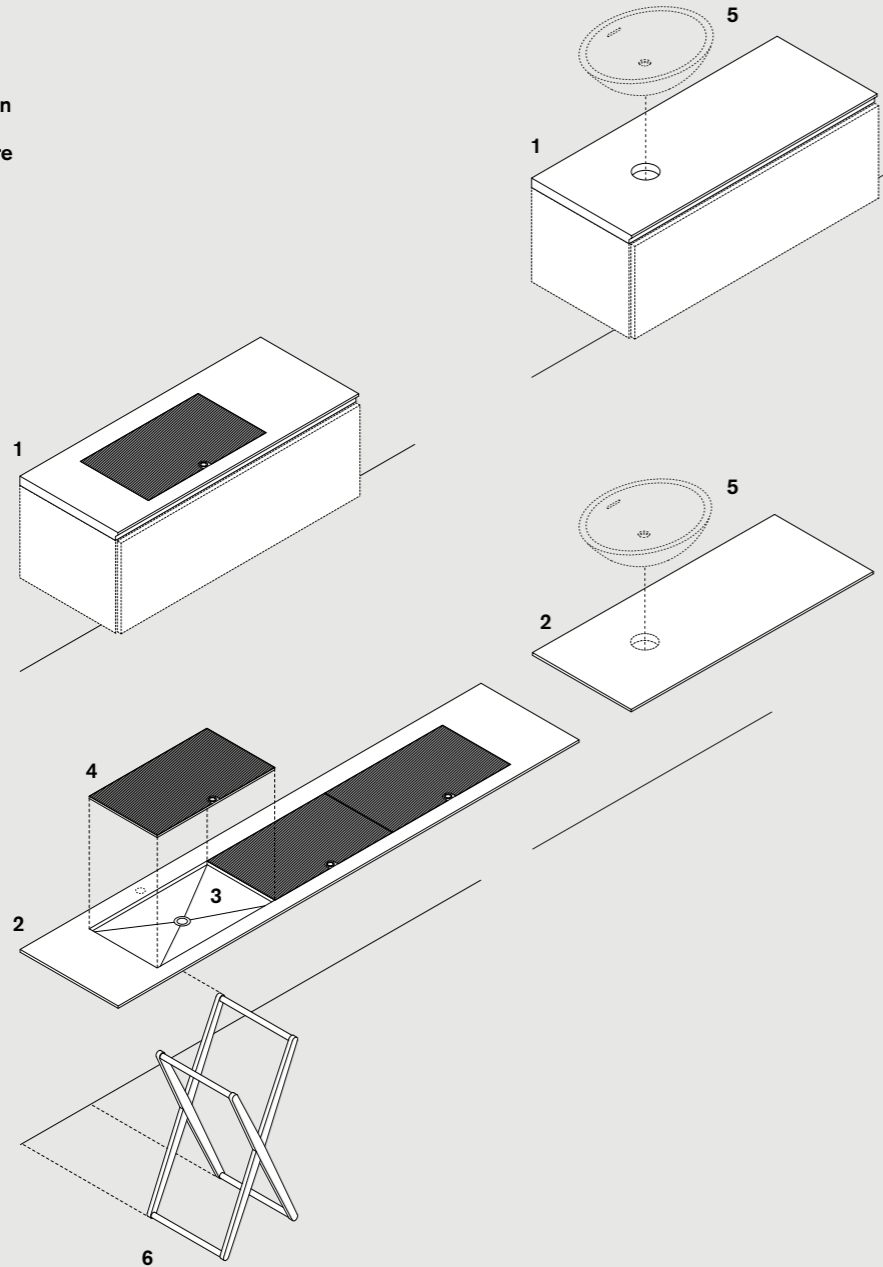

Bathrooms: EII piano lavabo / washbasin countertop

Il piano-lavabo EII, disegnato da Benedini Associati con Andrés Jost e Diego Cisi, si presenta come un segno grafico sottile, reso ancora più leggero da una rastrematura che da uno spessore di soli 38,5 mm, si assottiglia fino a diventare 10 mm ai bordi. Elevate sono le possibilità di configurazione, per dare vita a un abaco completo di soluzioni, insieme ai contenitori Lato. EII può avere invasi integrati, liberamente posizionabili in qualsiasi punto del piano, oppure può essere completato da lavabi da appoggio. Realizzato in Corian® o marmo, EII è disponibile autoportante, con staffe a parete, oppure in appoggio sui contenitori Lato. La versione autoportante può essere completata da una struttura laterale in legno massello a forma di X, con funzione di porta salviette, collocabile a piacere in prossimità del piano.

Designed by Benedini Associati with Andrés Jost and Diego Cisi, the EII washbasin-countertop looks like a slender line drawing, made even lighter by the fact that it tapers from a mere 38.5 mm to 10 mm at the edges. Its versatility means it can be adapted to a whole range of solutions and it is compatible with Lato cabinets. EII can have integrated cavities, freely placed anywhere in the counter top, or it can be completed with counter top basins. Made of Corian® or marble, EII is available in the self-supporting version, with wall brackets or placed on Lato storage units. The wall-mounted version can be completed with an X-shaped solid wood side structure, for use as a towel-holder, which can be positioned near the countertop as desired.



Square
rubinetteria taps



EII
piano lavabo washbasin countertop
– Corian®
– marmo *marble*
L 200 × P 50 cm



027
specchio contenitore *mirror unit*



Square
rubinetteria taps



EII
piano lavabo washbasin countertop
– Corian®
– marmo *marble*
L 200 × P 50 cm



X
complementi *extras*

Lato
programma *programme*





○ **Memory**
accessori *accessories*

○ **Memory 2**
rubinetteria *taps*

○ **EII**
piano lavabo *washbasin countertop*
– Corian®
– marmo *marble*
L 300 × P 50 cm



○ **Insegna**
specchio *mirror*

○ **Memory 2**
rubinetteria *taps*

○ **Lato**
programma *programme*

○ **EII**
piano lavabo *washbasin countertop*
– Corian®
– marmo *marble*
L 300 × P 50 cm

○ **X**
complementi *extras*
— legno *wood*
L 49 – 63 × P 23 × H 79 cm

Memory 2
rubinetteria taps



EII
piano lavabo washbasin countertop
- Corian®
- marmo marble
L 260 x P 50 cm

Puzzle
accessori per cassetti
accessories for drawers

Narciso
specchio mirror



Memory 2
rubinetteria taps

EII
piano lavabo washbasin countertop
- Corian®
- marmo marble
L 260 x P 50 cm

Lato
programma programme

Tre3
sedia chair
> Agapecasa



Dot Line
specchio *mirror*



Fez 2
rubinetteria *taps*



Vieques
lavabo *washbasin*



EII
piano lavabo *washbasin countertop*
– Corian®
– marmo *marble*
L 260 × P 50 cm



Eclissi
specchio *mirror*



Memory
accessori *accessories*



Memory 2
rubinetteria *taps*



Bijon 1
lavabo *washbasin*



EII
piano lavabo *washbasin countertop*
– Corian®
– marmo *marble*
L 260 × P 50 cm



Lato
programma *programme*



Piano lavabo Washbasin countertop

- Piano / Countertop**
larghezza / length: da / from cm 120 a / to cm 220
altezza / height: cm 2
profondità / depth: cm 50
finiture / finishes: marmo / marble
- Struttura / Structure**
larghezza / length: da / from cm 126 a / to cm 226
altezza / height: cm 25
profondità / depth: cm 50
finiture / finishes: ottone / brass, acciaio inox / stainless steel
- Cassa / Casing**
larghezza / length: da / from cm 120 a / to cm 220
altezza / height: cm 20
profondità / depth: cm 50
finiture / finishes: rovere / oak, legno precomposto con finitura teak / reconstituted wood, teak finish
- Frontale / Drawer front**
larghezza / length: cm 40, 60, 80, 100, 120
finiture / finishes: rovere / oak, legno precomposto con finitura teak / reconstituted wood, teak finish, cuoio / leather, marmo / marble

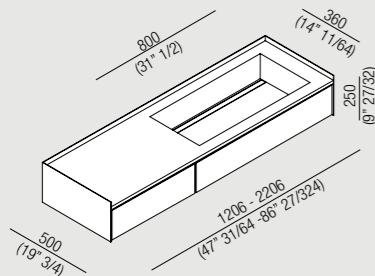

senza fori / whitout holes

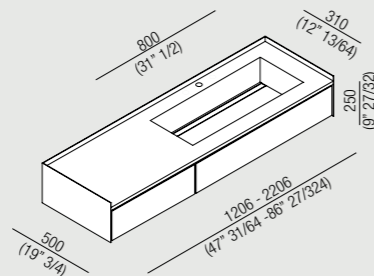

con un foro / whit one hole

Bathrooms: DR piano lavabo / washbasin countertop

Disegnato dallo StudioMK27, Marcio Kogan e Mariana Ruzante, il piano-lavabo DR è contraddistinto dalla ricercatezza e qualità dei suoi dettagli, principi alla base dei progetti architettonici dello studio brasiliano.

Il lavabo è incorniciato su tre lati da lastre di metallo.

L'invoso, integrato nel piano in marmo con lo scarico nascosto da una lastra dello stesso materiale, ha una forma rettangolare e può essere posizionato al centro, a destra o a sinistra.

Disponibile con lunghezze che vanno dai 120 ai 220 cm, per le dimensioni superiori ai 140 cm, DR prevede uno o più cassetti sottopiano collocati nella zona libera dal catino.

I frontali dei cassetti, riprendono i materiali e le finiture disponibili per il sistema Lato permettendo al lavabo di rispondere alle più diverse esigenze estetiche.

The DR washbasin top, designed by StudioMK27, Marcio Kogan and Mariana Ruzante, is distinguished by both its refinement and the quality of its details, characteristics that mark all the projects of this Brazilian architecture studio.

The washbasin is framed on three sides by metal plates.

The basin has a rectangular shaped and is integrated into the marble top with its drain hidden by a slab made of the same material. It can be placed either in the centre, to the right or to the left.

DR is available in lengths ranging from 120 to 220 cm and comes with one or more drawers placed under the top in the basin's free area for lengths exceeding 140 cm.

The front of the drawers adopts the Lato system materials and finishes to respond to the most varied aesthetic needs.



Flat D - A2
docce *showers*



Lift
contenitori *storage units*



Memory
accessori *accessories*



Memory 2
rubinetti *taps*



Nudo LED
specchio *mirror*



Memory 2
rubinetteria *taps*



DR
piano lavabo *washbasin countertop*
— marmo/ ottone/ legno
marbre/ brass/ wood
L 80,6 - 220,6 × P 50 × H 25 cm

Piani / Countertops

L 80 – 240 cm
P 50 cm

Evo – E1

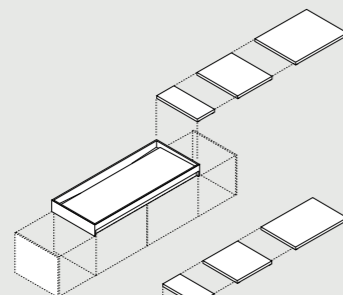

Evo – E2

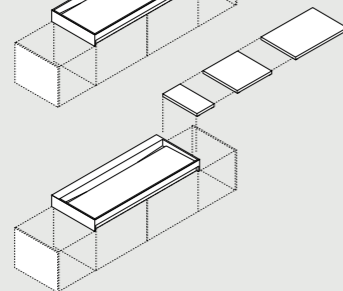

Evo – N

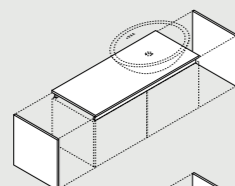

Evo – Nivis

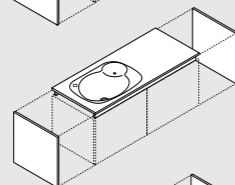

Evo – 800 001

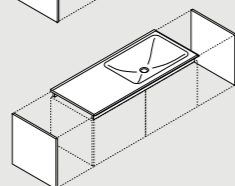

Piani porta oggetti
/ Shelves

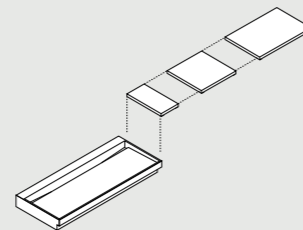

Evo – E2
Autoportante / Self-bearing

Contenitori / Storage units



Elemento di aggiustaggio
/ Buffer element

Frontale speciale
/ Customized drawer front

Bathrooms: Evoluzione programma / programme

Evoluzione è un programma di piani e contenitori per il bagno, disegnato da Benedini Associati ed introdotto nella gamma Agape nel 2010. La sua caratteristica principale è la realizzazione di composizioni integrate in un unico elemento, ma con una grande versatilità nelle dimensioni.

Il programma è composto da piani in Exmar, in Cristalplant® biobased, un materiale esclusivo di origine naturale, oppure in legno, compatibili con la maggior parte dei lavabi Agape e supportabili da contenitori. Questi ultimi sono dotati di ante sagomate che permettono l'apertura e la chiusura senza bisogno di maniglie.

Nello schema a lato sono illustrati i moduli principali che compongono il Programma Evoluzione.

Evoluzione is a collection of countertops and storage units for the bathroom, designed by Benedini Associati, and introduced into the Agape range in 2010. Its main characteristic is the creation of compositions that integrate to form a single element, but with great versatility in terms of dimensions.

The collection includes tops in wood, Exmar and Cristalplant® biobased, an exclusive material of natural origin, compatible with most Agape washbasins and mountable on the storage units. The units themselves are fitted with shaped doors, which can be opened and closed without the need for handles.

The drawings on the right show the main modules found in the Evoluzione collection.





Narciso
specchio *mirror*



Spai
specchio *mirror*



Evoluzione
programma *programme*
Evo-Nivis
L 200 × P 50 cm



Basket
complementi *extras*



Nudo LED
specchio *mirror*



Surf
accessori *accessories*



369
accessori *accessories*



Evoluzione
programma *programme*
Evo-E1
L 140 × P 50 cm



125 C
illuminazione *lighting*



Nudo
specchio *mirror*



Memory 2
rubinetteria *taps*



In-Out
lavabo *washbasin*



Evoluzione
programma *programme*
Evo-N
L 100 x P 50 cm



Memory 2
rubinetteria *taps*



In-Out
lavabo *washbasin*



Evoluzione
programma *programme*
Evo-N
L 100 x P 50 cm

Parabola
specchio *mirror*



Sen
rubinetteria *taps* / accessori
accessories



Evoluzione
programma *programme*
Evo-E1
L 240 x P 50 cm



Tre3
sedia *chair*
> Agapecasa



Parabola
specchio *mirror*



Square
rubinetteria *taps*



Evoluzione
programma *programme*
Evo-E1
L 240 x P 50 cm



Cartesio W
vasca *bathtub*





Memory
specchio *mirror*



Club 44
sedia *chair*
> Agapecasa



Spoon XL
lavabo *washbasin*



Evoluzione
programma *programme*
Evo-N
L 200 x P 50 cm



Narciso
specchio *mirror*



Spai
specchio *mirror*



Pic-nic
complementi *extras*



Evoluzione
programma *programme*
Evo-Ottocento 001
L 240 x P 50 cm



Piani / Countertops

L 80 - 240 cm

P 50 cm

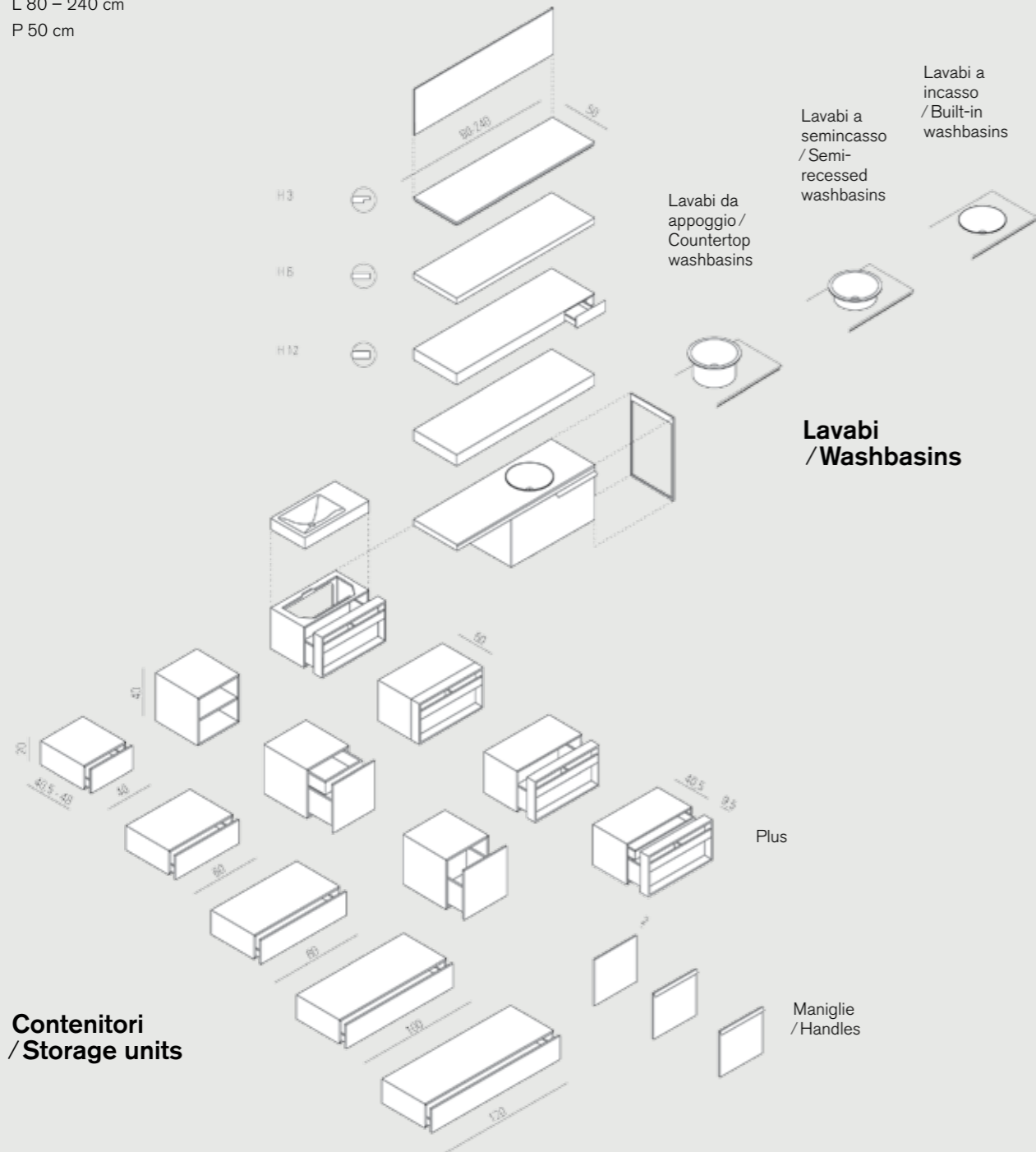

Contenitori / Storage units

Lavabi / Washbasins

Bathrooms: Flat XL programma / programme

Un vastissimo programma di elementi modulari, disegnato da Benedini Associati a partire dal 2002: piani in tre spessori (3 - 6 - 12 cm), strutture e contenitori che si integrano con i lavabi Agape, per arredare il bagno realizzando infinite composizioni, adattabili a qualsiasi situazione progettuale ed architettonica.

Un sistema che permette a ciascuno di trovare una soluzione ideale in ogni senso: nell'estetica, nei materiali, nell'utilizzo dello spazio, con totale facilità d'installazione, perfetta coerenza stilistica e accogliente funzionalità.

Nello schema a lato sono illustrati i moduli principali che compongono il Programma Flat XL.

A huge collection of modular elements, designed by Benedini Associati from 2002 onwards: countertops in three different thicknesses (3 - 6 - 12 cm), and support frames and storage units that integrate with Agape washbasins, decorating the bathroom with an endless range of compositions suitable for any shape, size or style of room.

A system that enables everyone to find the ideal solution from all points of view: aesthetics, materials, use of space, ease of installation, coherence of style and convenient functions and features.

The drawings on the right show the main modules found in the Flat XL collection.

Narciso
specchio *mirror*



Spai
specchio *mirror*



Surf
accessori *accessories*



Flat XL
programma *programme*
piano *top*
L 240 x P 50 x H 12 cm
contenitori *storage units*
L 60 x P 50 x H 20 cm
L 100 x P 50 x H 20 cm

Normal
vasca *bathtub*



Parabola
illuminazione *lighting*



Spoon XL
lavabo *washbasin*



Flat XL
programma *programme*
piano *top*
L 200 × P 50 × H 3 cm
contenitori *storage units*
L 100 × P 50 × H 40 cm

Spoon XL
vasca *bathub*



Memory
specchio *mirror*



Memory 2
rubinetteria *taps*



Flat XL-Ottocento 001
programma *programme*
piano *top*
L 240 x P 50 x H 6 cm



Flat XL
programma *programme*
contenitori *storage units*
L 100 x P 50 x H 20 cm
L 60 x P 50 x H 20 cm



Memory 2
rubinetteria *taps*



Ottocento
vasca *bathub*



027
specchio contenitore *mirror unit*



Ottocento 002
lavabo *washbasin*



Flat XL
programma *programme*
piano *top*
L 400 x P 50 x H 6 cm
contenitori *storage units*
L 60 x P 50 x H 40 cm
L 80 x P 50 x H 40 cm
L 100 x P 50 x H 40 cm



In-Out
vasca *bathub*





Bjoh 1
lavabo washbasin

Flat XL
programma *programme*
piano *top*
L 180 x P 50 x H 3 cm
contenitori *storage units*
L 80 x P 42,5 x H 40 cm Plus
L 100 x P 50 x H 40 cm



Memory
specchio *mirror*

Surf
complementi *extras*

Nivis
lavabo *washbasin*

Memory 2
rubinetteria *taps*

Flat XL
programma *programme*
piano *top*
L 200 x P 50 x H 12 cm

Fusilli
specchio *mirror*



Square
rubinetteria *taps*



○ **Nudo LED**
specchio *mirror*

○ **815**
lavabo *washbasin*

X
complementi *extras*



Flat XL
programma *programme*
contenitori *storage units*
L 80 x P 42,5 x H 40 cm Plus



Narciso
specchio *mirror*



Spai
specchio *mirror*



Memory 2
rubinetteria *taps*



Nivis
lavabo *washbasin*



Bucatini
accessori *accessories*



Memory
accessori *accessories*



Flat XL
programma *programme*
piano *top*
L 240 × P 50 × H 6 cm
contenitore *storage unit*
L 100 × P 50 × H 40 cm







○ Dot Line
specchio *mirror*

○ Square
rubinetteria *taps*

○ Dot Line
accessori *accessories*

○ Flat XL-Ottocento 002
programma *programme*
piano *top*
L 200 × P 50 × H 12 cm

○ Lato
programma *programme*

Programma / Programme

1. Struttura / Structure

larghezza / length: da / from cm 120 a / to cm 180 con 2 supporti / supports
da / from cm 200 a / to cm 300 con 3 supporti / supports
altezza / height: cm 15
profondità / depth: cm 33,5
finiture / finishes: alluminio / aluminium

2. Piano / Countertop

larghezza / length: cm 120
altezza / height: cm 2
profondità / depth: cm 47
finiture / finishes: marmo / marble

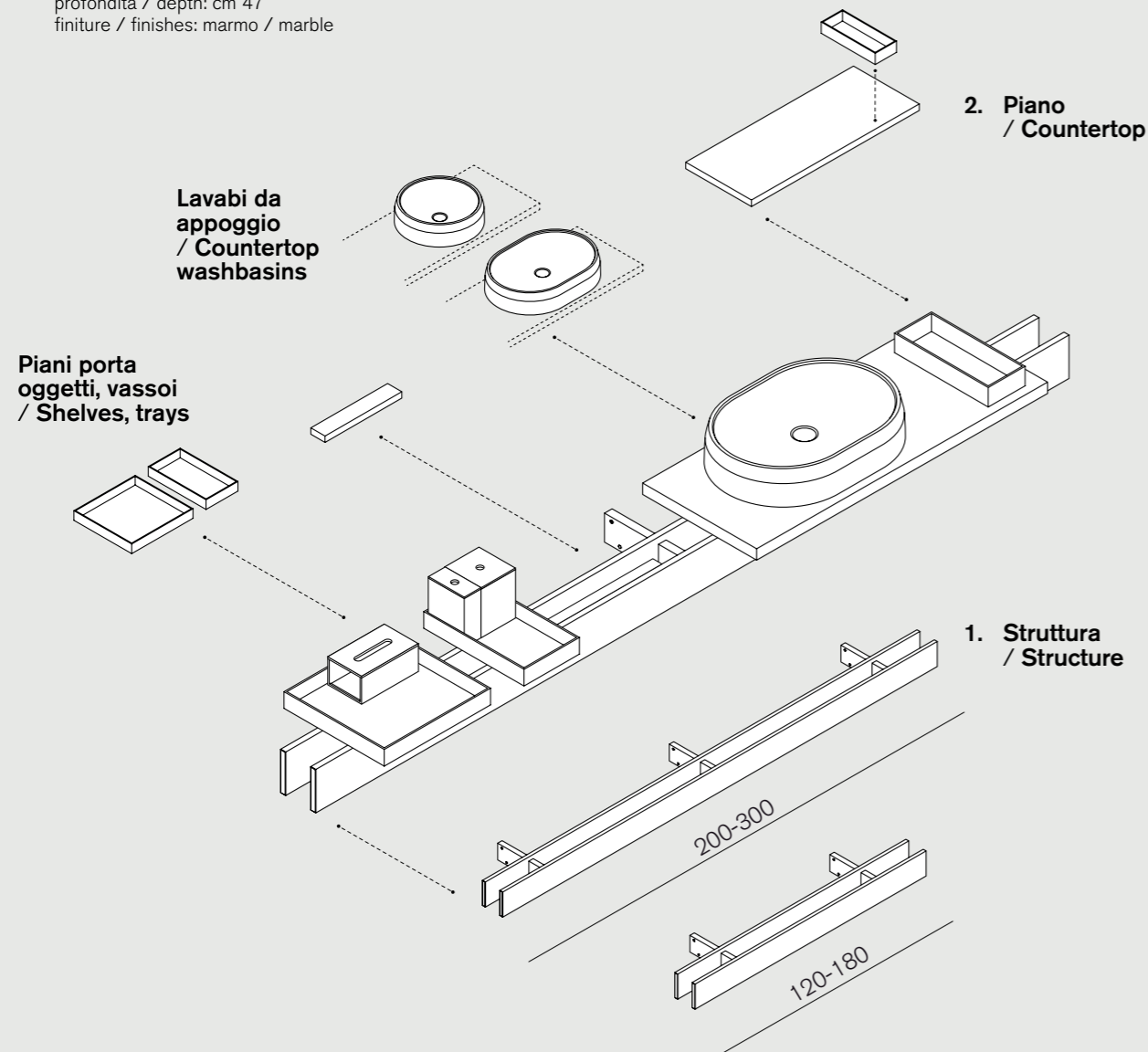

Bathrooms: Rigo programma / programme

Patricia Urquiola rinnova l'intensa collaborazione con Agape che dal 2004 ha dato vita ad alcuni dei nostri prodotti più iconici come la famiglia Vieques e Lariana.

Rigo è un sistema di arredo bagno di forte ispirazione architettonica. Due travi parallele corrono lungo il muro e definiscono uno spazio di appoggio lineare su cui vengono disposti lavabo e accessori.

Una serie dettagliata di vassoi e contenitori consentono molteplici configurazioni del sistema, dalle più semplici a quelle più articolate. L'accostamento di marmo, legno e alluminio anodizzato conferisce ricercatezza estetica e materica. Rigo è una traduzione minimale, una sintesi contemporanea dell'ambiente bagno tradizionale.

Patricia Urquiola renews its intense collaboration with Agape, which since 2004 has created some of our most iconic products such as the Vieques and Lariana family.

Rigo is a bathroom furniture system closely inspired by architecture. Two parallel beams run across the wall to create a linear opportunity to lay the washbasin and its accessories on.

A detailed set of trays and containers allow the system to take on miscellaneous configurations from the simplest to the most elaborate. Combining marble, wood and anodised aluminium adds aesthetic and material richness.

Rigo's minimal design becomes a modern-day synthesis of the conventional bathroom environment

Rigo
programma *programme*
- alluminio *aluminium*
L 120 - 300 x P 33,5 cm



Eclissi
specchio *mirror*



Sen
rubinetteria, accessori *taps, accessories*



Lariana
lavabo *washbasin*



Sen
rubinetteria *taps*



Lato
programma *programme*



Lariana
vasca *bathtub*





Fez
rubinetteria *taps*



Lariana
lavabo *washbasin*



Lato
programma *programme*



Rigo
programma *programme*
– alluminio *aluminium*
L 120 - 300 x P 33,5 cm



Memory
specchio *mirror*



Fez
rubinetteria *taps*



Lariana
lavabo *washbasin*



Rigo
programma *programme*
vassoi *trays*
– legno *wood*
L 41,2 x P 44,1/22,8 x H 6 cm



Glossario materiali

1) **Legno**
Il patrimonio tecnologico della cantieristica navale è un dato fondamentale nella progettazione di elementi in legno per il bagno. L'invecchiamento esalta le naturali doti estetiche del legno aumentando le prestazioni tecnologiche. Esteticamente ciò che più affascina del legno è il suo ciclo di vita, l'aspetto cangiante legato al passare del tempo e delle stagioni misurato attraverso il lento mutare della superficie, delle venature e del colore.

2) **Cristalplant®Biobased**
Cristalplant® è un materiale eco-sostenibile derivante da materie prime resinose di origine vegetale miscelate a materiali inerti naturali di estrema purezza. La superficie, con effetto "soft-touch" ha un aspetto simile alla pietra naturale che lo rende particolarmente indicato per l'utilizzo nell'ambiente bagno. Il materiale è omogeneo in tutto il suo spessore e può facilmente essere ripristinato.

3) **Exmar**
Materiale ottenuto dalla composizione di resina e polvere di quarzo. La superficie, con finitura satinata bianca, è setosa, calda e piacevole al tatto. L'applicazione dell'Exmar nella realizzazione di vasche da bagno è ideale poiché il materiale possiede la capacità di trattenere a lungo il calore dell'acqua.

4) **Solid surface**
Materiale compatto e non poroso, composto in modo omogeneo da 1/3 di resina acrilica e da 2/3 di idrossido di alluminio, un minerale naturale con il quale molte persone si trovano quotidianamente a contatto, poiché costituisce, ad esempio, un componente importante dei dentifrici. Completamente atossico e riciclabile. La superficie si presenta omogenea, setosa al tatto, durevole e facile da pulire.

5) **Ceramilux®**
Materiale composito realizzato con cariche minerali naturali (carbonati di calcio e idrati di

alluminio) miscelate a resina poliestere; rivestimento con gelcoat a base poliestere isoneopentilica. Ceramilux® è un materiale non assorbente, resistente agli sbalzi di temperatura, ai graffi e all'abrasione.

6) **Exacril**
Exacril è un metacrilato di rivestimento con superficie lucida (100 gloss a specchio) nato come alternativo al laccato lucido. Il forte spessore, 1,4 mm, consente incollaggi anche sui bordi con difettosità infinitesimali e lo rende ripristinabile ad eventuali graffi. La superficie lucida e resistente nel tempo, non perde brillantezza e non si deforma, resiste al calore, e impermeabile e non assorbente. È un prodotto atossico ed ecologico.

7) **Gomma siliconica**
La gomma siliconica è un polimero elastomero contenente atomi di silicio e di ossigeno. Il composto è stabile ed irreversibile, le proprietà meccaniche ed elastiche del materiale non subiscono variazioni in intervalli di temperature elevate. Le caratteristiche peculiari della gomma siliconica sono la morbidezza, la totale atossicità e la colorazione pura; qualità che permettono un'applicazione ideale laddove il materiale entra a contatto diretto con il corpo e con l'acqua. La flessibilità permette di rimuovere facilmente il calcare che si deposita durante l'utilizzo del prodotto.

8) **Ceramica**
Impasto di sostanze argillose a struttura compatta modellato e quindi consolidato mediante processi di cottura che ne garantiscono i processi di vetrificazione della superficie, di notevole resistenza meccanica ed elettrica.

9) **Marmo**
Roccia calcarea cristallizzata e compatta. La produzione Agape utilizza attualmente marmo bianco di Carrara con finitura satinata. I lavabi sono realizzati con lastre unite

tramite incollaggio o scavati direttamente su blocco.

10) **Acciaio Inox**
Il termine acciaio inossidabile (o inox) indica genericamente gli acciai ad alta lega contenenti cromo ed altri leganti che aumentano la resistenza alla corrosione. Materiale con doti di resistenza, durezza ed elasticità molto maggiori di quelle del ferro semplice. I prodotti Agape in acciaio inox subiscono trattamenti superficiali di lucidatura o di satinatura.

11) **Alluminio**
L'alluminio è un metallo morbido e leggero con un colore argenteo vivo, dovuto ad uno strato sottile di ossidazione che si forma rapidamente quando è esposto all'aria. È estremamente resistente alla corrosione atmosferica: per tale ragione non richiede nessuna verniciatura di protezione, ma può essere ugualmente trattato con un'ampia gamma di rivestimenti, dalle verniciature alle anodizzazioni colorate. L'alluminio è non magnetico, non tossico e non infiammabile.

12) **Ottone**
Col nome di ottone si indica una lega di rame e zinco, compresa nella più ampia famiglia del bronzo. È un metallo molto utile, grazie alla sua resistenza e lavorabilità. I prodotti Agape in ottone subiscono trattamenti superficiali di cromatura lucida o di cromatura satinata.

13) **Cristallo**
Costituito essenzialmente da silicati è ottenuto per fusione di sabbia silicea con ossidi e carbonati. Grazie alla perfetta trasparenza, all'inalterabilità e alla capacità di reagire alla luce in forma mutevole, il cristallo trova particolare applicazione negli accostamenti con gli altri materiali che compongono la produzione Agape. Le giunzioni tra le parti sono realizzate con speciali collanti che garantiscono la perfetta trasparenza e continuità del materiale.

Glossary of materials

1) **Wood**
The technological know-how gained in the ship-building industry is an essential factor when designing wooden components for the bathroom. Ageing enhances the natural appearance of wood, increasing its technological performance. Aesthetically, the most fascinating thing about wood is its life cycle, its changing appearance as time and seasons go by, evidenced by slow alteration of the surface, grain and colour.

2) **Cristalplant®Biobased**
Cristalplant® is an environmentally safe material deriving from resinous raw materials of vegetable origin mixed to natural aggregates of extreme purity. The "soft touch" surface looks like natural stone, which makes it particularly suitable for use in the bathroom. The material has a uniform structure throughout and can easily be touched up to restore the original finish.

3) **Exmar**
A composite material formed by a mix of resin and quartz powders. Its white, satin-finish surface is silky, warm and pleasant to the touch. It is ideal for use in the production of bathtubs as it is able to retain the heat of the water for a long time.

4) **Solid surface**
A compact, non-porous material which is a homogeneous mix of 1/3 resin and 2/3 aluminium hydroxide, a natural mineral with which many people are in daily contact as it constitutes, for example, an important ingredient of toothpaste. Completely non-toxic and recyclable. The surface is smooth, silky to the touch, durable and easy to clean.

5) **Ceramilux®**
Composite material made with natural mineral content (calcium carbonates and aluminium hydrates) mixed with polyester resins; coated with polyester-based iso-neopentyllic gelcoat. Ceramilux® is a non absorbent

material, resistant to changes in temperature, scratches and abrasion.

6) **Exacril**
Exacril is a methacrylate used for coating with glossy surface (100 gloss units), developed as an alternative to the high-gloss paint finish. Its greater thickness, 1,4 mm, even allows bonding of the edges with highest resistance and durability and enables to repair possible scratches. Its glossy surface is long lasting, retains its original brightness and does not deform; it is heat resistant, waterproof and not absorbent. A non-toxic and ecological product.

7) **Silicone rubber**
Silicone rubber is an elastomer polymer containing atoms of silicone and oxygen. The compound is stable and irreversible and its mechanical and elastic properties are not subject to alteration at higher temperatures. The specific characteristics of silicone rubber are softness, total non-toxicity and purity of colour. These qualities make it ideal for use where the material comes into direct contact with the body and water. Its flexibility allows easy removal of any lime scale deposited during use of the product.

8) **Ceramic**
A mixture of clayey substances with a compact structure that is moulded and then hardened by firing, which causes the surface to vitrify and acquire great mechanical and electrical resistance.

9) **Marble**
Marble is a compact, crystallized, calcareous rock. Agape currently uses white Carrara marble with satin-finish for its products. Washbasins are made from slabs joined together by gluing or carved directly out of the block.

10) **Stainless steel**
Stainless steel is the generic term for high alloy steels

containing chromium and other alloying elements that increase resistance to corrosion. A material that is much stronger, harder and more resilient than plain iron. Agape stainless steel products are surface-treated to give a polished or satin finish.

11) **Aluminium**
Aluminium is a soft, light metal, with a bright silver colour due to the thin oxide layer which quickly forms when it is exposed to the air. It is extremely resistant to atmospheric corrosion and therefore does not require any protective varnish, although it can take a wide range of finishes, from varnish coating to coloured anodising treatments. Aluminium is neither magnetic, nor toxic, nor flammable.

12) **Brass**
Brass is an alloy of copper and zinc and forms part of the wider bronze family. It is a very useful metal because it is tough yet easy to work. Agape brass products are chromium-plated with a polished or satin finish.

13) **Crystal glass**
Consisting mainly of silicates, it is obtained by fusing siliceous sand with oxides and carbonates. Because of its perfect transparency, inalterability and its ability to react to light in different ways, crystal glass is particularly suitable for juxtaposition with the other materials used by Agape for its product ranges. Parts are joined using special adhesives that ensure perfect transparency and continuity of the material.

Agape factory



La cultura del progetto

Agape viene fondata nel 1973 dalla famiglia Benedini. 40 anni di attività nel settore bagno durante i quali due fratelli, entrambi architetti, si sono succeduti alla guida dell'azienda. Giampaolo, designer di molti dei prodotti di maggior successo, è una figura chiave per l'innovativa interpretazione della stanza da bagno: da luogo funzionale a spazio fondamentale dell'abitare contemporaneo. Emanuele, dagli anni '90 alla direzione, è riuscito a mantenere coerente nel tempo l'estetica delle collezioni, continuando a dare spazio ai prodotti disegnati dal fratello e selezionando progettisti internazionali tra i più interessanti ed importanti. Ha inoltre guidato l'azienda verso l'internazionalizzazione portando Agape in tutto il mondo con un fatturato export intorno al 70% del fatturato totale. Agape per prima ha proposto una gamma completa di prodotti e accessori per arredare la stanza da bagno, intesa come spazio architettonico.

Design culture

Agape was founded in 1973 by the Benedini family. During these 40 years of experience in the bathroom sector the two brothers, both architects, have taken turns in running the business. Designer of many of the company's most successful products, Giampaolo has played a key role in creating new concept of bathroom: from indispensable room to fundamental part of contemporary living. Since the 1990s Emanuele has been responsible for running the company, successfully keeping the beauty of the collections constant; giving space to the products designed by his brother as well as individuating some of the most interesting designers currently on the international scene. He has given the company international status, producing an export turnover of approximately 70% of the total. Agape was the first to offer a complete range of products and accessories for the bathroom, conceived as an architectural space.



L'innovazione Made in Italy

Per risolvere al meglio le esigenze e le caratteristiche dei suoi progetti Agape, grazie anche alla sua posizione strategica, seleziona in Italia i migliori fornitori, i materiali più adatti e i processi produttivi più efficaci per offrire un livello di qualità più elevato rispetto agli standard del mercato. Per questo motivo Agape privilegia rapporti di partnership con aziende e artigiani con i quali è possibile condividere la passione per la ricerca e l'innovazione. In questo modo raggiunge soluzioni esclusive dalla forte identità, che nel tempo sono divenute icone del design. Made in Italy reale, unione di talento creativo e qualità.

Lo spazio del benessere

Mantova, sede dell'azienda, è città baricentrica tra Milano, capitale della moda e del design, l'Emilia, regione italiana da secoli luogo dei piaceri e qualità della vita ed il Veneto, espressione dell'innovazione ed efficienza produttiva del made in Italy. Agape rappresenta la sintesi perfetta tra questi tre mondi. Dalla somma di estetica, passione e innovazione nascono nuove interpretazioni del benessere legate alla lettura del tempo come rottura di una routine, come intervallo misurato e consacrato alla cura di sé stessi.

Innovation Made in Italy

To address the needs and characteristics of its projects Agape, helped by its strategic location, selects the best suppliers in Italy, the most suitable materials and the most effective production processes to provide a quality level that surpasses the market standard. Agape favours partnerships with companies and artisans who share its passion for research and innovation, thereby enabling it to achieve unique solutions with a strong identity that through time have become design icons. Real Made in Italy, the union between creative talent and quality.

A space for wellbeing

Mantua, where the company headquarters are located, sits in the middle between Milan, capital of fashion and design, and the Emilia region, a place where pleasures and quality of life have been consolidated over the centuries, and the Veneto region, which embodies the innovation and efficient manufacturing that characterises the Made in Italy brand. Agape is a perfect combination of these three worlds. From the formula aesthetics + passion + innovation springs a new interpretation of well-being, whereby time is seen as a break in routine, as a studied pause consecrated to moments uniquely for us.



Sede operativa Agape / Agape headquarters building

Agape Design Service

Per offrire al progettista e ai partners commerciali una consulenza commerciale Agape introduce Agape Design Service. Il servizio si avvale dell'esperienza e delle strutture di Agape Retail e del suo team di interior designer, da anni attivi nella progettazione di soluzioni per i punti vendita, per il settore contract e per i clienti privati. Agape Design Service supporta l'attività dei progettisti e dei rivenditori sviluppando proposte progettuali per l'ambiente bagno.

Maggiori informazioni sul sito
www.agapedesign.it/designservice

Concept store Agape 12

Agape12 è un concept store nel cuore del Brera Design District che integra il negozio di arredamento e complementi con gli spazi dedicati alla progettazione. È un luogo dove i clienti di Agape possono trovare ispirazione e idee oltre che consulenza professionale e assistenza in ogni fase di realizzazione di un progetto. 850 mq di spazi espositivi su quattro livelli, svelano un'offerta esclusiva per i diversi ambienti della casa voluta e selezionata da Agape. Agape12 propone, attraverso una costante attività di scouting, le migliori realtà dell'arredo e delle finiture d'interni presentando unicamente complementi architettonici, prodotti e accessori che siano espressione di una reale qualità, misurabile per valore estetico-funzionale e durabilità nel tempo. Marchi importanti mescolati con realtà emergenti, italiane e internazionali, industriali e artigiane, dalle finiture d'interni agli oggetti semplici per la vita di ogni giorno.

Maggiori informazioni sul sito
www.agape12.it



Concept store Agape 12

Agape Design Service

Agape Design Service offers designers and business partners a personalized consulting service. The experience and facilities of the Agape Retail team have for many years been put to the service of retail stores, the Contract division and private clients. Agape Design Service supports designers and retailers, developing design solutions for bathrooms.

For more info
www.agapedesign.it/designservice

Concept store Agape 12

Agape12 is a concept store in the heart of the Brera Design District that integrates the furniture and accessory store with the spaces dedicated to planning. It is a space for Agape clients to find inspirations and ideas beyond the professional advice and assistance in any step of realization. 850mq of exhibition space on four levels reveal an exclusive selection for the different spaces of the house wanted and chosen by Agape. Agape12 suggests, thanks to a constant activity of scouting, the best realities of furnishing and interior design presenting exclusively architectonic complements, products and accessories that are expression of a real quality, measurable by aesthetic-functional value and durability. Important brands mixed with ascending realities, Italian and international, industrial and manual, from interior design to the simple objects for every day life.

Maggiori informazioni sul sito
www.agape12.it

Sostenibilità

Da sempre attenta a ogni singola fase del processo produttivo, dal confronto con il progettista all'industrializzazione, dalla gestione logistica del prodotto finito alla messa in opera, Agape studia proposte progettuali complete, frutto della meticolosa ricerca di codici espressivi durevoli nel tempo per qualità estetiche, materiche e funzionali. Un approccio sostenibile che rispetta i principi fondamentali della sostenibilità: durabilità tecnica ed estetica, impegno nella gestione delle risorse energetiche e materiali, ricerca sui materiali e sulle soluzioni che garantiscano il minor impatto ambientale possibile nel totale rispetto per le persone e il territorio. In questa prospettiva Agape, con la collaborazione di Habitech e TÜV Italia, ha effettuato la mappatura dei suoi prodotti secondo lo standard di certificazione LEED®, anticipando l'utilizzo di nuovi materiali eco-sostenibili certificati. Oltre a quelli tradizionalmente utilizzati, tutti di alto livello qualitativo e prodotti in Italia, Agape ha per prima inserito a catalogo numerosi prodotti realizzati in Cristalplant biobased, innovativo Solid surface ecologico per composizione e caratteristiche tecniche, performante, facilmente ripristinabile e riciclabile.

Maggiori informazioni sul sito
www.agapedesign.it/sostenibilita

Certifications

I prodotti Agape contribuiscono a soddisfare i requisiti dei crediti LEED®

Agape è socio Green Building Council Italia



UNI EN ISO
9001:2008



(USA, Canada)



(Europa)



Water efficiency
(Singapore)



Sustainability

Attentive to each stage of the production process, Agape studies complete design proposals, from consultation with the designer right through to production, logistics of the finished product and installation. All of these are the result of a meticulous research for codes of expression whose aesthetic appearance, material and functional quality will all last well into the future.

Ours is a sustainable approach that respects the principles of sustainability: technical and aesthetic durability, committed management of energy and material resources, research into materials and solutions to ensure the lowest environmental impact possible for people and the environment. In this perspective Agape, in collaboration with Habitech and TÜV Italy, mapped its products according to the standards of LEED® certification, anticipating the use of new eco-certified sustainable materials. In addition to those traditionally used, all of high quality and produced in Italy, Agape was the first to include in its catalogue numerous products made of Cristalplant biobased. This®ecological Solid surface is innovative in its composition, technical characteristics and performance and has an added plus: it can be easily restored and recycled.

For more info
www.agapedesign.it/sustainability

Certifications

Agape products contribute to the allocation of LEED® credits

Agape is member of the Italian Green Building Council

Designed by:

- | | |
|--|-------------------------------------|
| 1 Benedini Associati | 15 Patricia Urquiola |
| 2 Fabio Bortolani | 16 UT Agape |
| 3 Ermanno Righi | 17 Andres Jost |
| 4 Daniele Dalla Pellegrina | 18 Studioepepe |
| 5 Alessandro Farnetti | 19 Diego Cisi |
| 6 Giulio Gianturco | 20 Garcia/ Cumini |
| 7 Konstantin Grcic | 21 Lucidi/ Pevere |
| 8 Gwenael Nicolas/ Curiosity | 22 Mario Tessarollo |
| 9 Luigi Lanzi | 23 Sebastian Herkner |
| 10 Gergely Ágoston/ RD Agape | 24 Marco Merendi |
| 11 Angelo Mangiarotti | 25 Diego Vencato |
| 12 Studio MK27/ Marcio Kogan/
Mariana Ruzante | 26 Neri & Hu |
| 13 Giuseppe Pasquali | 27 Shiro Studio/
Andrea Morgante |
| 14 Javier Lòpez | |





Sede operativa Agape / Agape headquarters building



Graphic design: Designwork
Copywriting: Agape, Daniele Varelli
Translation: Isobel Butters
Photography: Andrea Ferrari,
Filippo Bamberghi,
ContrattiCompany, F2,
Federica Bottoli, Andrea Gnesato,
Luca Marri, Patricia Parinejad,
Giorgio Possenti, Leo Torri,
Daici Ano, Studio Haas,
Marzio Bondavalli, Juan Rodriguez,
Mads Mogensen
Colour separation: Lucegroup, CD cromo
Printed by:

©Agape srl 03.2019



Agape srl
via A. Pitentino, 6 / 46037 Governolo
Roncoferraro (MN), Italy
T +39 0376 250311 / F +39 0376 250330
info@agapedesign.it
www.agapedesign.it

CATBATHROOMS1903

Agape bathrooms:

Lavabi / Washbasins, Sanitari / Sanitary ware,
Vasche / Bathtubs, Docce / Showers, Rubinetti
/ Taps, Accessori / Accessories, Complementi /
Extras, Illuminazione / Lighting, Specchi / Mirrors,
Specchi contenitori / Mirror units, Contenitori /
Storage units, Programma / Programme.

Agape srl

via A. Pitentino, 6 / 46037 Governolo
Roncoferraro (MN), Italy
T +39 0376 250311 / F +39 0376 250330
e-mail: info@agapedesign.it
www.agapedesign.it