

**POCKET**

**0 1 8**

**antoniolupi**

bagnarsi ad arte\_bathing with art



**POCKET**  
**0 1 8**

4 - 19	BESPOKE
20 - 29	ATELIER
30 - 41	PANTA REI
42 - 51	PIANA
52 - 55	PIANETA
56 - 61	LUNARIA
62 - 69	GESTO
70 - 79	GRAFFIO
80 - 85	SIMPLO
86 - 95	ILBAGNO
96 - 111	SANITARI / SANITARY-WARE
112 - 119	CRISTALMOOD
120 - 173	TOP / TOPS
174 - 259	LAVABI / SINKS
260 - 299	VASCHE / TUBS
300 - 321	PIATTI E BOX DOCCIA / <i>TRAYS AND SHOWER ENCLOSURES</i>
322 - 365	SOFFIONI / <i>OVERHEAD SHOWERS</i>
366 - 407	RUBINETTERIA / <i>TAPS</i>
408 - 419	TERMOARREDI / <i>DESIGNER RADIATORS</i>
420 - 435	COLLAGE
436 - 487	ILLUMINAZIONE E SPECCHIERE / <i>LIGHTING AND MIRRORS</i>
488 - 535	COMPLEMENTI E ACCESSORI / <i>FURNISHINGS AND ACCESSORIES</i>
536	INFORMAZIONI ENERGETICHE / <i>ENERGETIC INFORMATION</i>
537 - 551	AZIENDA / <i>COMPANY</i>

INDICE / INDEX

**antoniolupi**

bagnarsi ad arte\_bathing with art











BESPOKE







BESPOKE













BESPOKE







BESPOKE







BESPOKE







BESPOKE









SISTEMA ATELIER

ATELIER SYSTEM

L'anta è composta da un profilo in alluminio con frontale in legno che a seconda di come viene posizionato all'interno del profilo crea una gola o maniglia donando un segno grafico alla composizione. La gola può essere posta in orizzontale totalmente o parzialmente rispetto allo sviluppo del mobile, ma anche collocata lungo i lati verticali o addirittura "incorniciare" i quattro lati, permette di personalizzare questa microarchitettura domestica conferendo profondità alla superficie.

The door is composed of an aluminum profile with a wooden front which, depending on how it is positioned it creates a groove or handle donating a graphic sign to the composition.

The handle can be placed horizontally, totally or partially, with respect to the rest of the furniture, but also placed along the vertical sides or even "frame" the four sides allowing you to customize a domestic micro-architecture and giving depth to the surface.

È necessario scegliere la finitura dei frontali identificata dai numeri 3 e 4, la tipologia di maniglia identificata dalle lettere A-B-C-D-E-F-G-H e la finitura del telaio in alluminio bronzo-titanio-zirconio-champagne. La struttura è in finitura skin cenere.

It is necessary to choose the finish of the fronts identified by numbers 3 and 4, the type of handle identified by the letters A-B-C-D-E-F-G-H and the finish of the aluminum frame in bronzo-titanio-zirconio-champagne. The structure is in skin cenere.

MANIGLIE / HANDLES

ESEMPI DI COMPOSIZIONI / COMPOSITION EXMPLES

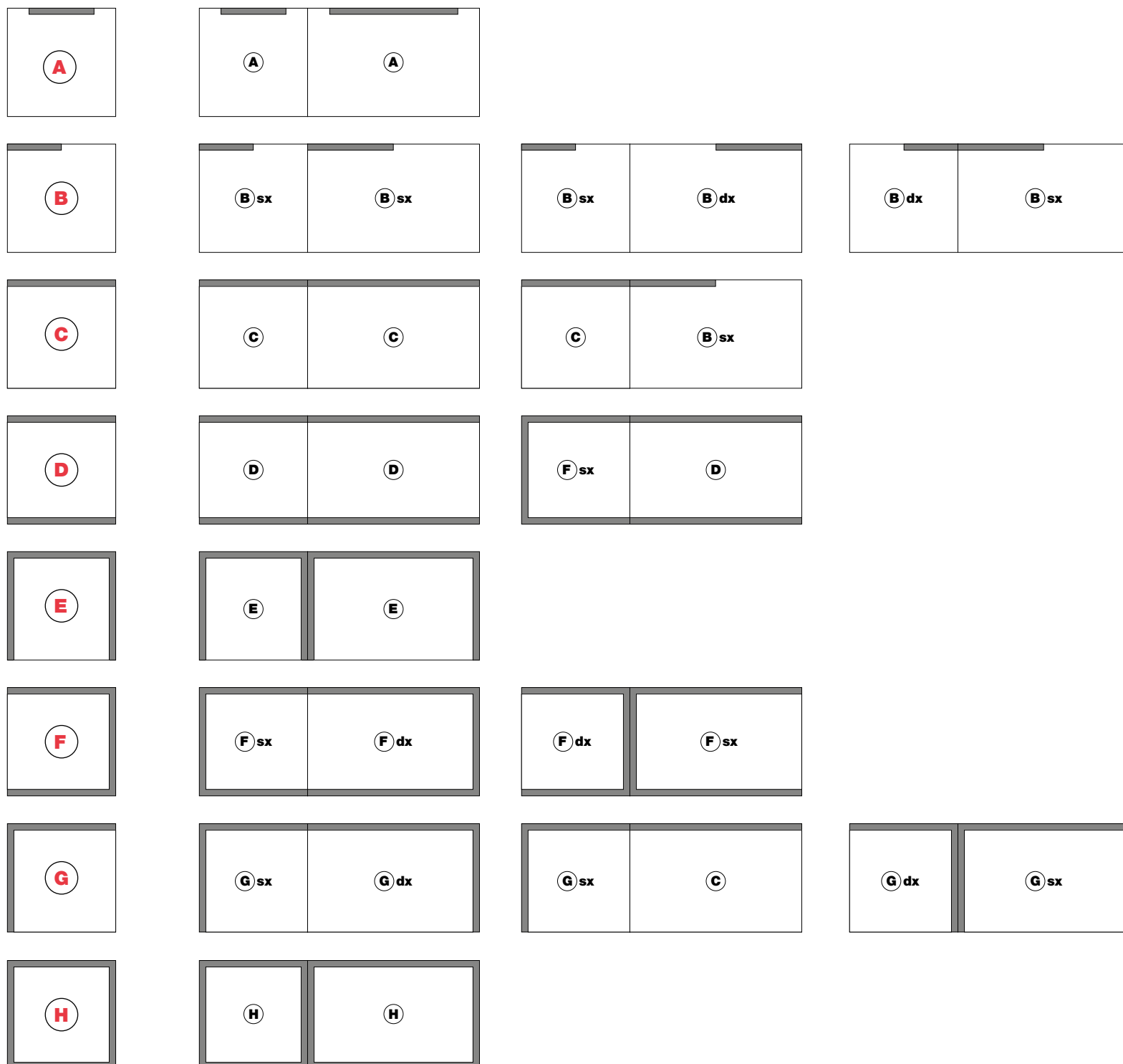





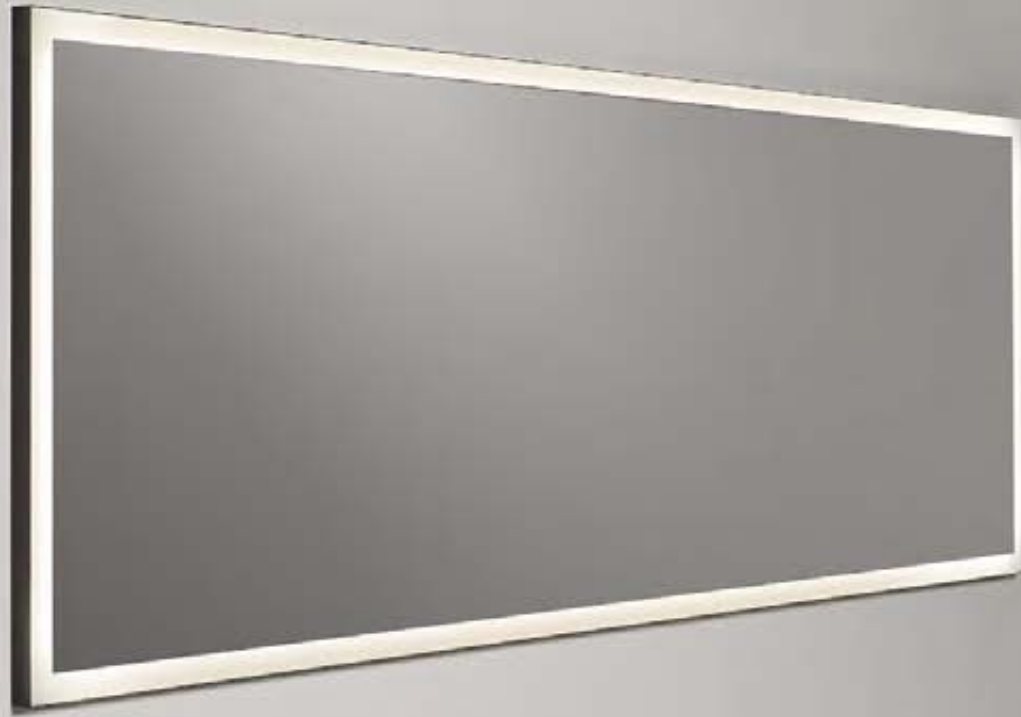





















PANTA REI





























PIANA design Nevio Tellatin







PIANA







PIANA







PIANA







PIANA























LUNARIA







LUNARIA









## GEST054 + GSTKI154

H	P	L	art.
13	40	54	GEST054

Lavabo rettangolare sopraiano o da parete in Ceramilux lucido o opaco, completo di piletta con scarico libero e raccordo per sifone.

*Rectangular top mount or wall mount glossy or matt Ceramilux sink, complete with drain pipe fitting and open plug.*

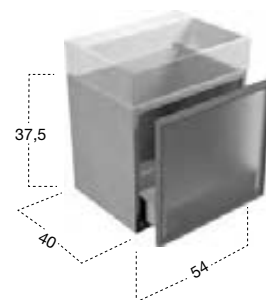

H	P	L	art.
37,5	40	54	GSTKI154

Porta lavabo con 1 cassetto Art. SLIM, abbinabile solo con lavabo Art. GEST054.

*Sink unit with 1 drawer Art. SLIM to be combined with Art. GEST054.*

H	P	L	art.
13	50	63	GEST063

Lavabo rettangolare sopraiano o da parete in Ceramilux lucido o opaco completo di piletta con scarico libero e raccordo per sifone.

*Rectangular top mount or wall mount glossy or matt Ceramilux sink complete with drain pipe fitting and open plug.*

## GEST063 + GSTKI163 / GSTKA163

H	P	L	art.
37,5	50	63	GSTKI163
50	50	63	GSTKA163

Porta lavabo con 1 cassetto Art. SLIM, abbinabile solo con lavabo Art. GEST063.

*Sink unit with 1 drawer Art. SLIM to be combined with Art. GEST063.*

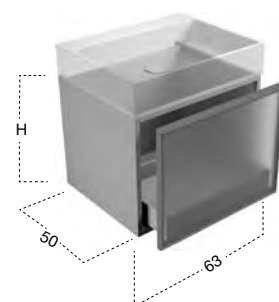

H	P	L	art.
13	50	90	GEST090

Lavabo rettangolare sopraiano o da parete in Ceramilux lucido o opaco completo di piletta con scarico libero e raccordo per sifone.

*Rectangular top mount or wall mount glossy or matt Ceramilux sink complete with drain pipe fitting and open plug.*

## GEST090 + GSTKI190 / GSTKA190

H	P	L	art.
37,5	50	90	GSTKI190
50	50	90	GSTKA190

Porta lavabo con 1 cassetto Art. SLIM, abbinabile solo con lavabo Art. GEST090.

*Sink unit with 1 drawer Art. SLIM to be combined with Art. GEST090.*

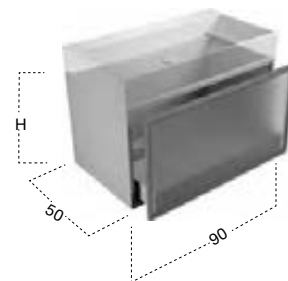

H	P	L	art.
13	50	126	GEST0126

Lavabo rettangolare sopraiano o da parete in Ceramilux lucido o opaco completo di piletta con scarico libero e raccordo per sifone.

*Rectangular top mount or wall mount glossy or matt Ceramilux sink complete with drain pipe fitting and open plug.*

## GEST0126 + GSTKI1126 / GSTKA1126

H	P	L	art.
37,5	50	126	GSTKI1126
50	50	126	GSTKA1126

Porta lavabo con 1 cassetto Art. SLIM, abbinabile solo con lavabo Art. GEST0126.

*Sink unit with 1 drawer Art. SLIM to be combined with Art. GEST0126.*

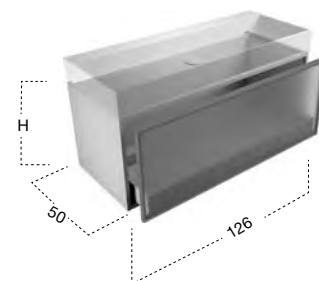

GESTO







art. ELETTRA / ELETTRACH ( per Svizzera / for Switzerland)

N° 2 prese di corrente opzionali per cassetti.

*N° 2 optional sockets for drawers.*

H	P	L	art.
13	40	54	GEST054

Lavabo rettangolare sopra piano o da parete in Ceramilux lucido o opaco, completo di piletta con scarico libero e raccordo per sifone.

*Rectangular top mount or wall mount glossy or matt Ceramilux sink, complete with drain pipe fitting and open plug.*

H	P	L	art.
37,5	40	54	GEST012454

Portalavabo con 1 cassetto Art. SLIM, abbinabile solo con lavabo Art. GEST054.

*Sink unit with 1 drawer Art. SLIM to be combined with Art. GEST054 sink.*

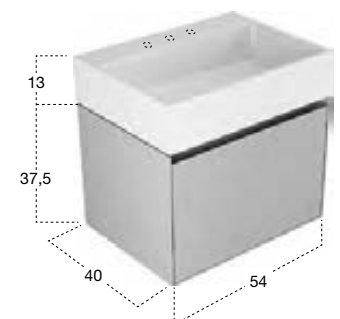

GESTO



## GEST063 + GEST012563 / GEST013563

H	P	L	art.
13	50	63	GEST063

Lavabo rettangolare sopraiano o da parete in Ceramilux lucido o opaco completo di piletta con scarico libero e raccordo per sifone.

*Rectangular top mount or wall mount glossy or matt Ceramilux sink complete with drain pipe fitting and open plug.*

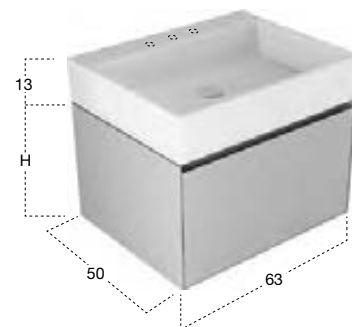

H	P	L	art.
37,5	50	63	GEST012563
50	50	63	GEST013563

Porta lavabo con 1 cassetto Art. SLIM, abbinabile solo con lavabo Art. GEST063.

*Sink unit with a Art. SLIM drawer to be combined with sink Art. GEST063.*

## GEST090 + GEST012590 / GEST013590

H	P	L	art.
13	50	90	GEST090

Lavabo rettangolare sopraiano o da parete in Ceramilux lucido o opaco completo di piletta con scarico libero e raccordo per sifone.

*Rectangular top mount or wall mount glossy or matt Ceramilux sink complete with drain pipe fitting and open plug.*

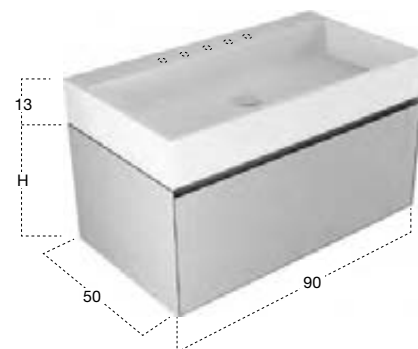

H	P	L	art.
37,5	50	90	GEST012590
50	50	90	GEST013590

Porta lavabo con 1 cassetto Art. SLIM, abbinabile solo con lavabo Art. GEST090.

*Sink unit with a Art. SLIM drawer to be combined with sink Art. GEST090.*

## GEST0126 + GEST0125126 / GEST0135126

H	P	L	art.
13	50	126	GEST0126

Lavabo rettangolare sopraiano o da parete in Ceramilux lucido o opaco completo di piletta con scarico libero e raccordo per sifone.

*Rectangular top mount or wall mount glossy or matt Ceramilux sink complete with drain pipe fitting and open plug.*



H	P	L	art.
37,5	50	126	GEST0125126
50	50	126	GEST0135126

Porta lavabo con 1 cassetto Art. SLIM, abbinabile solo con lavabo Art. GEST0126.

*Sink unit with a Art. SLIM drawer to be combined with sink Art. GEST0126*





## GEST063 + GEST033563

H	P	L	art.
13	50	63	GEST063

Lavabo rettangolare sopra piano o da parete in Ceramilux lucido o opaco completo di piletta con scarico libero e raccordo per sifone.

*Rectangular top mount or wall mount glossy or matt Ceramilux sink complete with drain pipe fitting and open plug.*

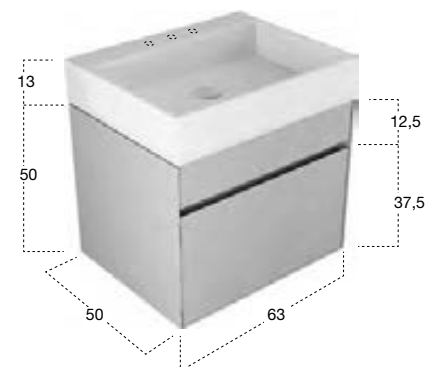

H	P	L	art.
50	50	63	GEST033563

Porta lavabo con 2 cassetti Art. SLIM di cui 1 sagomato internamente per sifone, abbinabile solo con lavabo Art. GEST063.

*Sink unit with 2 drawers Art. SLIM, one of which internally shaped for siphon, to be combined with sink Art. GEST063.*

## GEST090 + GEST033590

H	P	L	art.
13	50	90	GEST090

Lavabo rettangolare sopra piano o da parete in Ceramilux lucido o opaco completo di piletta con scarico libero e raccordo per sifone.

*Rectangular top mount or wall mount glossy or matt Ceramilux sink complete with drain pipe fitting and open plug.*

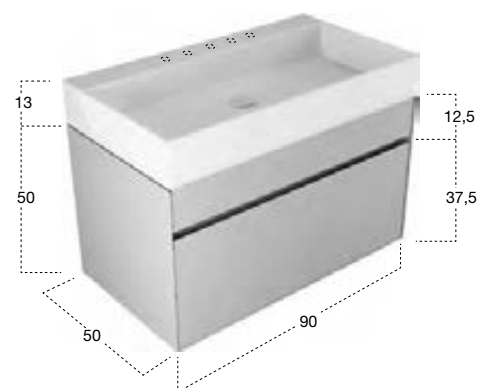

H	P	L	art.
50	50	90	GEST033590

Porta lavabo con 2 cassetti Art. SLIM di cui 1 sagomato internamente per sifone, abbinabile solo con lavabo Art. GEST090.

*Sink unit with 2 drawers Art. SLIM, one of which internally shaped for siphon, to be combined with sink Art. GEST090.*

## GEST0126 + GEST0335126

H	P	L	art.
13	50	126	GEST0126

Lavabo rettangolare sopra piano o da parete in Ceramilux lucido o opaco completo di piletta con scarico libero e raccordo per sifone.

*Rectangular top mount or wall mount glossy or matt Ceramilux sink complete with drain pipe fitting and open plug.*



H	P	L	art.
50	50	126	GEST0335126

Porta lavabo con 2 cassetti Art. SLIM di cui 1 sagomato internamente per sifone, abbinabile solo con lavabo Art. GEST0126.

*Sink unit with 2 drawers Art. SLIM, one of which internally shaped for siphon, to be combined with sink Art. GEST0126.*







GRAFFIO



## GRAFFIO54 + GRFKI154 / GRFKA154

H	P	L	art.
12	50	54	GRAFFIO54

Lavabo rettangolare sopra piano o da parete in Ceramilux con ripiano, completo di piletta con scarico libero e raccordo per sifone.

*Rectangular top mount or wall mount Ceramilux sink with shelf, complete with drain pipe fitting and open plug.*

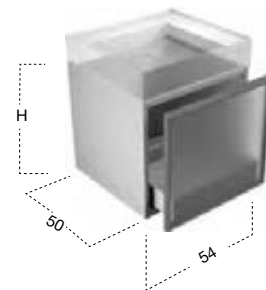

H	P	L	art.
37,5	50	54	GRFKI154
50	50	54	GRFKA154

Porta lavabo con 1 cassetto Art. SLIM, abbinabile solo con lavabo Art. GRAFFIO54.

*Sink unit with 1 drawer Art. SLIM to be combined with Art. GRAFFIO54.*

## GRAFFIO90 + GRFKI190 / GRFKA190

H	P	L	art.
12	50	90	GRAFFIO90

Lavabo rettangolare sopra piano o da parete in Ceramilux con ripiano, completo di piletta con scarico libero e raccordo per sifone.

*Rectangular top mount or wall mount Ceramilux sink with shelf, complete with drain pipe fitting and open plug.*

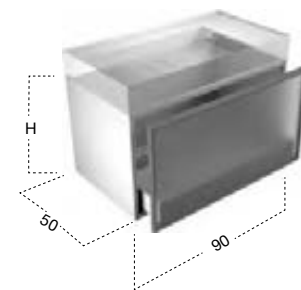

H	P	L	art.
37,5	50	90	GRFKI190
50	50	90	GRFKA190

Porta lavabo con 1 cassetto Art. SLIM, abbinabile solo con lavabo Art. GRAFFIO90.

*Sink unit with 1 drawer Art. SLIM to be combined with Art. GRAFFIO90.*

## GRAFFIO108 + GRFKI1108 / GRFKA1108

H	P	L	art.
12	50	108	GRAFFIO108

Lavabo rettangolare sopra piano o da parete in Ceramilux con ripiano, completo di piletta con scarico libero e raccordo per sifone.

*Rectangular top mount or wall mount Ceramilux sink with shelf, complete with drain pipe fitting and open plug.*

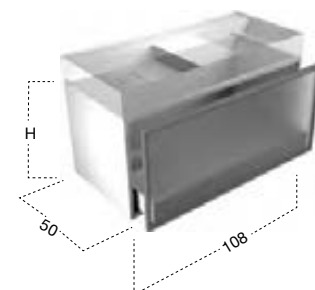

H	P	L	art.
37,5	50	108	GRFKI1108
50	50	108	GRFKA1108

Porta lavabo con 1 cassetto Art. SLIM, abbinabile solo con lavabo Art. GRAFFIO108.

*Sink unit with 1 drawer Art. SLIM to be combined with Art. GRAFFIO108.*



GRAFFIO



## GRAFFIO54

H	P	L	art.
12	50	54	GRAFFIO54

Lavabo rettangolare sopra piano o da parete in Ceramilux con ripiano, completo di piletta con scarico libero e raccordo per sifone.

*Rectangular top mount or wall mount Ceramilux sink with shelf, complete with drain pipe fitting and open plug.*

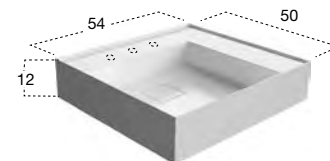

## GRAFFIO12554

H	P	L	art.
37,5	50	54	GRAFFIO12554

PortLavabo con 1 cassetto Art. SLIM, abbinabile solo con lavabo Art. GRAFFIO54.

*Sink unit with 1 drawer Art. SLIM, to be combined with Art. GRAFFIO54.*

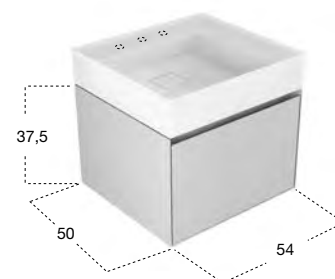

## GRAFFIO13554

H	P	L	art.
50	50	54	GRAFFIO13554

PortLavabo con 1 cassetto Art. SLIM, abbinabile solo con lavabo Art. GRAFFIO54.

*Sink unit with 1 drawer Art. SLIM, to be combined with Art. GRAFFIO54.*

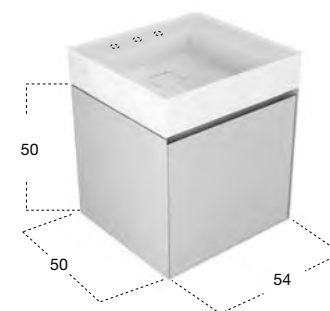

## GRAFFIO33554

H	P	L	art.
50	50	54	GRAFFIO33554

PortLavabo con 2 cassetti Art. SLIM di cui uno sagomato internamente per sifone, abbinabile solo con lavabo Art. GRAFFIO54.

*Sink unit with 2 drawers Art. SLIM, one of which internally shaped for siphon, to be combined with Art. GRAFFIO54.*

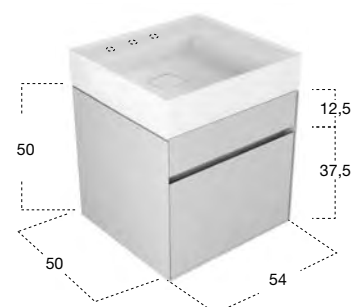

GRAFFIO



## GRAFFIO90

H	P	L	art.
12	50	90	GRAFFIO90

Lavabo rettangolare sopra piano o da parete in Ceramilux con ripiano, completo di piletta con scarico libero e raccordo per sifone.

*Rectangular top mount or wall mount Ceramilux sink with shelf, complete with drain pipe fitting and open plug.*

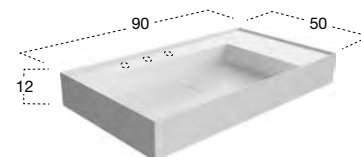

## GRAFFIO12590

H	P	L	art.
37,5	50	90	GRAFFIO12590

Porta lavabo con 1 cassetto Art. SLIM, abbinabile solo con lavabo Art. GRAFFIO90.

*Sink unit with 1 drawer Art. SLIM, to be combined with Art. GRAFFIO90.*

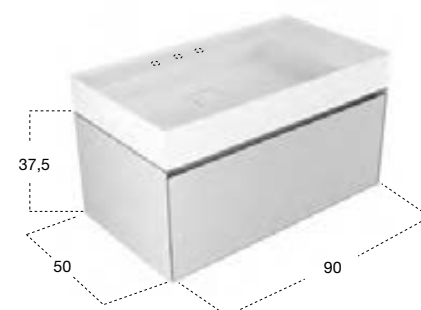

## GRAFFIO13590

H	P	L	art.
50	50	90	GRAFFIO13590

Porta lavabo con 1 cassetto Art. SLIM, abbinabile solo con lavabo Art. GRAFFIO90.

*Sink unit with 1 drawer Art. SLIM, to be combined with Art. GRAFFIO90.*

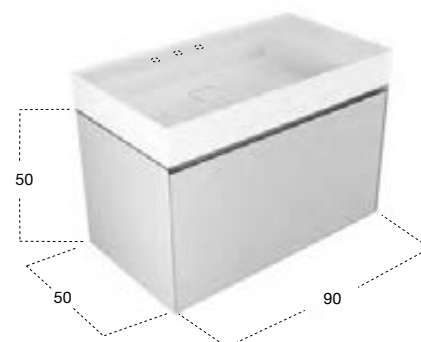

## GRAFFIO33590

H	P	L	art.
50	50	90	GRAFFIO33590

Porta lavabo con 2 cassetti Art. SLIM di cui uno sagomato internamente per sifone, abbinabile solo con lavabo Art. GRAFFIO90.

*Sink unit with 2 drawers Art. SLIM, one of which internally shaped for siphon, to be combined with Art. GRAFFIO90.*

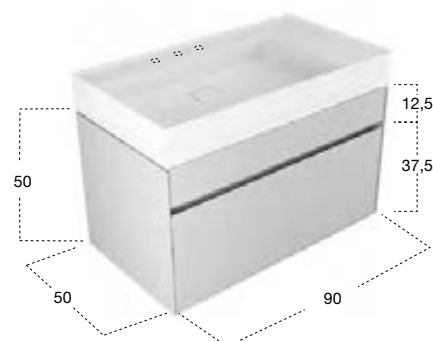



GRAFFIO



## GRAFFIO108

H	P	L	art.
12	50	108	GRAFFIO108

Lavabo rettangolare sopra piano o da parete in Ceramilux con ripiano, completo di piletta con scarico libero e raccordo per sifone.

*Rectangular top mount or wall mount Ceramilux sink with shelf, complete with drain pipe fitting and open plug.*

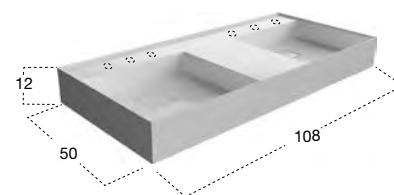

## GRAFFIO125108

H	P	L	art.
37,5	50	108	GRAFFIO125108

Porta lavabo con 1 cassetto Art. SLIM, abbinabile solo con lavabo Art. GRAFFIO108.

*Sink unit with 1 drawer Art. SLIM, to be combined with Art. GRAFFIO108.*

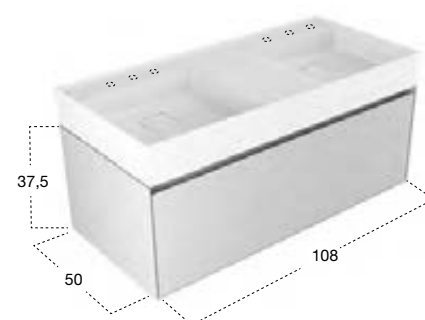

## GRAFFIO135108

H	P	L	art.
50	50	108	GRAFFIO135108

Porta lavabo con 1 cassetto Art. SLIM, abbinabile solo con lavabo Art. GRAFFIO108.

*Sink unit with 1 drawer Art. SLIM, to be combined with Art. GRAFFIO108.*

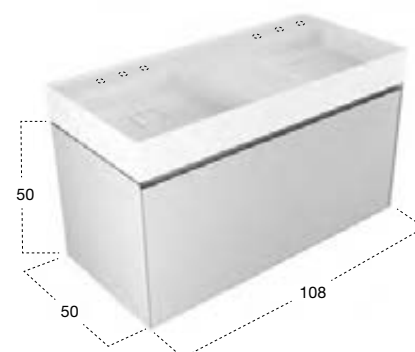

## GRAFFIO335108

H	P	L	art.
50	50	108	GRAFFIO335108

Porta lavabo con 2 cassette Art. SLIM di cui uno sagomato internamente per sifone, abbinabile solo con lavabo Art. GRAFFIO108.

*Sink unit with 2 drawers Art. SLIM, one of which internally shaped for siphon, to be combined with Art. GRAFFIO108.*

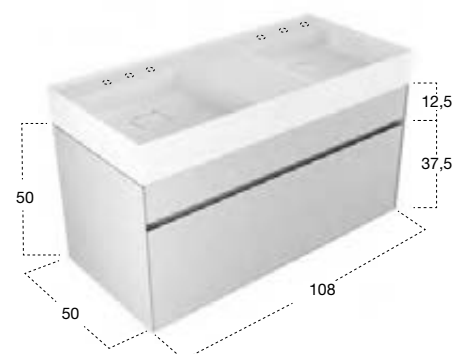







SIMPLO

SIMPLO108 + SMP11108





## SIMPL042 + SMPI5142

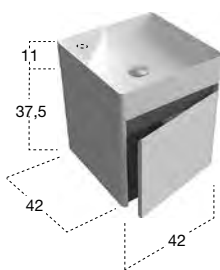

\* Verniciabile esternamente in tutti i colori del nostro campionario  
Can be externally lacquered in all colors of our collection

H	P	L	art.
11	42	42	SIMPL042 *

Lavabo quadrato sopra piano dx o sx in Flumood completo di piletta con scarico libero e raccordo per sifone.

*Right or left hand square top mount Flumood sink complete with drain pipe fitting and open plug.*

H	P	L	art.
37,5	42	42	SMPI5142

Porta lavabo dx o sx con 1 anta, abbinabile solo con lavabo Art. SIMPL042.

*Right or left single door sink unit to be combined with Art. SIMPL042*

## SIMPL054 + SMPI154

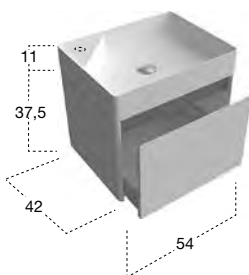

H	P	L	art.
11	42	54	SIMPL054 *

Lavabo rettangolare sopra piano in Flumood completo di piletta con scarico libero e raccordo per sifone.

*Rectangular top mount Flumood sink complete with drain pipe fitting and open plug.*

H	P	L	art.
37,5	42	54	SMPI154

Porta lavabo con 1 cassetto Art. SLIM, abbinabile solo con lavabo Art. SIMPL054.

*Sink unit with 1 drawer Art. SLIM to be combined with Art. SIMPL054.*

## SIMPL063 + SMPI163

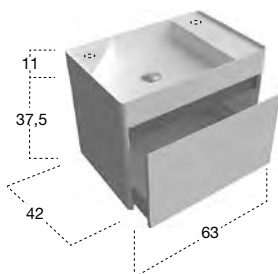

H	P	L	art.
11	42	63	SIMPL063 *

Lavabo rettangolare sopra piano in Flumood completo di piletta con scarico libero e raccordo per sifone.

*Rectangular top mount Flumood sink complete with drain pipe fitting and open plug.*

H	P	L	art.
37,5	42	63	SMPI163

Porta lavabo con 1 cassetto Art. SLIM, abbinabile solo con lavabo Art. SIMPL063.

*Sink unit with 1 drawer Art. SLIM to be combined with Art. SIMPL063.*

## SIMPL0108 + SMPI1108

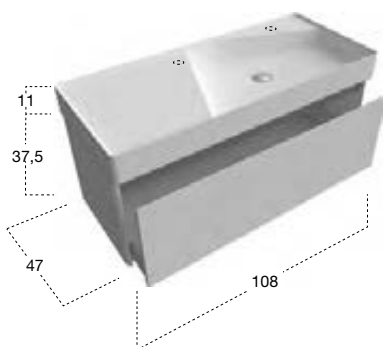

H	P	L	art.
11	47	108	SIMPL0108 *

Lavabo rettangolare sopra piano in Flumood completo di piletta con scarico libero e raccordo per sifone.

*Rectangular top mount Flumood sink complete with drain pipe fitting and open plug.*

H	P	L	art.
37,5	47	108	SMPI1108

Porta lavabo con 1 cassetto Art. SLIM, abbinabile solo con lavabo Art. SIMPL0108.

*Sink unit with 1 drawer Art. SLIM to be combined with Art. SIMPL0108.*



H	P	L	art.
11	25	45	SIMPLOMANI

Lavabo rettangolare sopra piano o da parete in Flumood, completo di piletta con scarico libero e raccordo per sifone.

*Rectangular top mount or wall mount Flumood sink, complete with drain pipe fitting and open plug.*

H	P	L	art.
50	25	45	SIMPAMANI

Porta lavabo dx o sx con 1 anta e 1 ripiano interno, abbinabile solo con lavabo Art. SIMPLOMANI versione A e C.

*Right or left single door sink unit with 1 internal shelf to be combined with Art. SIMPLOMANI in version A and C.*

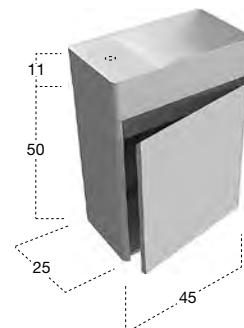







































H	P	L	art.	
26	54	36	KOMODO1	Ceramica Lucida / High gloss Ceramic
26	54	36	KOMODO3	Ceramica Satinata / Satin Ceramic

Vaso in ceramica lucida o satinata, sospeso con scarico a parete, completo di sedile avvolgente FLAT con sistema di sganciamento rapido, realizzato in resina termoindurente con chiusura rallentata "soft-close".

*High gloss or satin suspended ceramic water closet with wall drain, complete with seat and cover FLAT made of thermosetting resin, quick release system and soft closing hinges.*

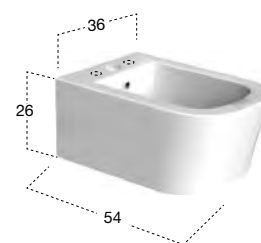

H	P	L	art.	
26	54	36	KOMODO2	Ceramica Lucida / High gloss Ceramic
26	54	36	KOMODO4	Ceramica Satinata / Satin Ceramic

Bidet monoforo in ceramica lucida o satinata, sospeso con scarico a parete.

*High gloss or satin suspended ceramic bidet with wall drainage and single tap hole.*



SISTEMA "LESS\_RING" / "LESS\_RING" FLUSHING SYSTEM



Il vaso in ceramica della collezione Cabo, utilizza il sistema LESS\_RING che oltre a garantire una perfetta pulizia del volume interno e massima capacità di sciacquo, dona all'insieme un'immagine finale gradevole. Il movimento circolare consente di lavare in modo preciso e senza spruzzi tutta la superficie, contrariamente a quanto avveniva con i normali vasi con la brida, per un'igiene del 100%.

*The ceramic water closet, from the Cabo collection, uses the LESS\_RING system that ensures perfect internal cleaning and a maximum ability to rinse. The circular movement allows to wash in a precise manner and without splashing, contrary to what happens with standard water closets with a rim, to assure 100% hygiene.*

H	P	L	art.	
26	54	36,6	CABO1	Ceramica Lucida / High gloss Ceramic
26	54	36,6	CABO3	Ceramica Satinata / Satin Ceramic

Vaso in ceramica lucida o satinata, sospeso con scarico a parete e sistema senza brida, completo di sedile avvolgente FLAT con sistema di sganciamento rapido, realizzato in resina termoindurente con chiusura rallentata "soft-close".

*High gloss or satin suspended ceramic water closet with wall drain and washdown rimless flushing, complete with seat and cover FLAT made of thermosetting resin, quick release system and soft closing hinges.*

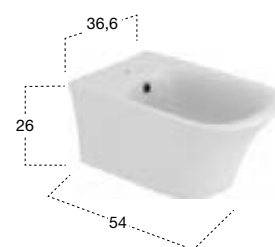

H	P	L	art.	
26	54	36,6	CABO2	Ceramica Lucida / High gloss Ceramic
26	54	36,6	CABO4	Ceramica Satinata / Satin Ceramic

Bidet monoforo in ceramica lucida o satinata, sospeso con scarico a parete.

*High gloss or satin suspended ceramic bidet with wall drainage and single tap hole.*



# CABO



SISTEMA "LESS\_RING" / "LESS\_RING" FLUSHING SYSTEM



H	P	L	art.	
42	54	36,6	CAB021	Ceramica Lucida / High gloss Ceramic
42	54	36,6	CAB023	Ceramica Satinata / Satin Ceramic

Vaso in ceramica lucida o satinata, da terra con scarico a pavimento o a parete e sistema senza brida, completo di sedile avvolgente FLAT con sistema di sganciamento rapido, realizzato in resina termoindurente con chiusura rallentata "soft-close".

*High gloss or satin freestanding ceramic water closet with floor or wall drain and washdown rimless flushing, complete with seat and cover FLAT made of thermosetting resin, quick release system and soft closing hinges.*

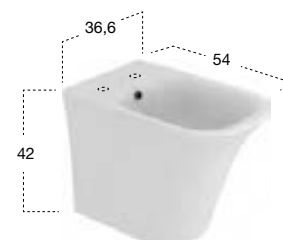

H	P	L	art.	
42	54	36,6	CAB022	Ceramica Lucida / High gloss Ceramic
42	54	36,6	CAB024	Ceramica Satinata / Satin Ceramic

Bidet monoforo in ceramica lucida o satinata, da terra con scarico a parete.

*High gloss or satin freestanding ceramic bidet with wall drainage and single center tap hole.*



Sedile con sistema di sganciamento rapido.

*Seat and cover with quick release system.*



Sedile con chiusura rallentata "soft-close".

*Seat and cover with soft closing hinges.*



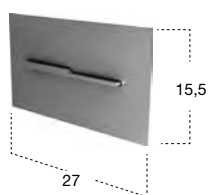

H	L	art.
15,5	27	ONDA

Placca di comando per cassetta wc a tasto unico basculante per il risciacquo a due quantità in acciaio inox AISI 304 satinato, lucido e grafite, completa di kit adattatore di montaggio.

*Mechanical dual flush plate for toilet cisterns in satin, polished stainless or graphite steel AISI 304 complete with installation adapter kit.*

## CARTATENSO design GI-RA

Modello e design registrato, brevetto depositato  
Registered model and design, patent pending



H	P	L	art.
50	8	34	CARTATENSO

Porta carta e idroscopino da incasso in acciaio inox satinato o lucido con doppio sistema di apertura e chiusura acqua e flessibile di 85 cm ad alta pressione.

*Encased hydrobrush cleaner and paper roll holder in satin or polished stainless steel with double opening and closing water system and high pressure flexible hose 85 cm.*

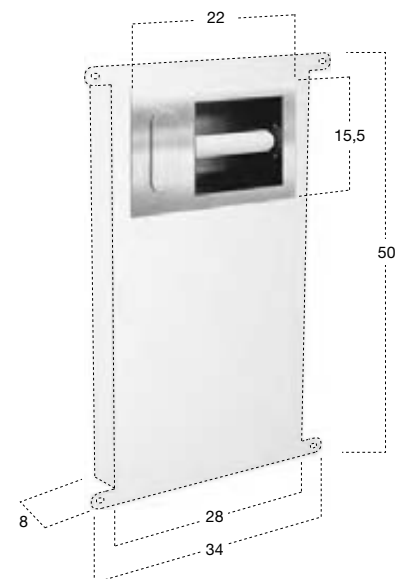

TENSO design GI-RA

Modello e design registrato, brevetto depositato  
*Registered model and design, patent pending*





H	P	L	art.
50	8	34	TENSO

Idroscopino da incasso in acciaio inox satinato o lucido con doppio sistema di apertura e chiusura acqua e flessibile 85 cm ad alta pressione.

*Encased hydrobrush cleaner in satin or polished stainless steel with double opening and closing water system and high pressure flexible hose 85 cm.*

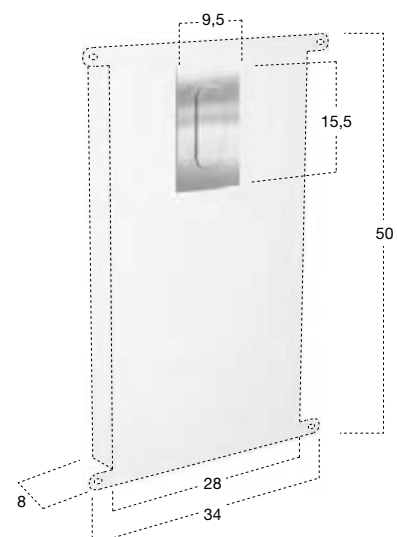



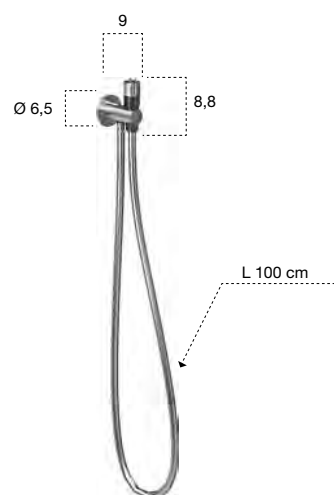

H	P	L	art.
8,8	9	6,5	GIRO_SCHIZZO

Idroscopino in acciaio inox satinato AISI 316/L con presa d'acqua e chiusura integrata al supporto a parete, completo di flessibile 100 cm ad alta pressione.

*Wall mounted hydrobrush in satin stainless steel AISI 316/L complete with support and water outlet, high pressure flexible hose 100 cm.*



## CRISTALMOOD

Un nuovo materiale frutto della ricerca antoniolupi, si aggiunge al Flumood e al Quarzomood.

Battezzato Cristalmood per le sue caratteristiche di trasparenza e lucentezza, è una resina di nuova generazione, colorabile, resistente, versatile. Nato per produrre lavabi abbinabili ai più diversi materiali, creando raffinati abbinamenti cromatici, come nel caso dei lavabi freestanding Albume di Carlo Colombo, Cristalmood, date le sue straordinarie caratteristiche, è già stato utilizzato anche in scala più grande per realizzare Reflex, la nuova vasca design AL Studio.

Cristalmood è una resina colorata, trasparente, a finitura lucida, composta da resina poliestere di alta qualità e pigmenti coloranti; ha superato i test anticorrosione (nebbia salina) e può essere pulito con tutti i detergenti più comuni, resistendo anche ad alcool denaturato, acetone, olii, benzene o gasolio.

Grazie alla loro composizione, gli oggetti in Cristalmood hanno un peso inferiore di circa il 30% rispetto a quelli realizzati con i solid surface come ad esempio il nostro Flumood.

## CRISTALMOOD

*A new material, result of the antoniolupi research, is added to Flumood and Quarzomood. Baptized Cristalmood due to its transparency and sheen, a new generation colored resin, resistant and versatile. Created to produce sinks combined with the most diverse materials, achieving refined color combinations, as in the case of Carlo Colombo's freestanding sinks Albume. Cristalmood, given its extraordinary characteristics, has already been used on a larger scale to make Reflex, the new bathtub by AL Studio design.*

*Cristalmood is a colored resin, transparent with a glossy finish, composed of high quality polyester resin and coloring pigments; has passed the anti-corrosion tests (salt spray) and can be cleaned with all the most common detergents, also resisting to rubbing alcohol, acetone, oils, gasoline or diesel fuel.*

*Thanks to the composition, objects made from Cristalmood weigh about 30% less than those made with solid surfaces such as our own Flumood.*











Colonna / Pedestal  
Cristalmood

Art. ALBUME10



+

Art. ALBUME20



H	Ø	L	art.
20,5	48	60	ALBUME10

Lavabo tondo in Cristalmood, disponibile in diversi colori come da nostro campionario, sopraiano o abbinabile con colonna art. ALBUME20 e ALBUME21, completo di piletta con scarico libero e raccordo per sifone.

Round sink in Cristalmood, avialbe in various colors, top mount or to be combined with pedestal art. ALBUME20 and ALBUME21 complete with drain pipe fitting and open plug.

H	Ø	art.
65,5	28	ALBUME20

Colonna da terra in Cristalmood o in resina verniciata, disponibile in diversi colori come da nostro campionario, con scarico a pavimento, sifone e tubo flessibile.

Pedestal in stone or Cristalmood available in various colors with floor drainage, siphon and flexible hose.



Colonna / Pedestal  
Nero Marquinia

H	Ø	L	art.
20,5	48	60	ALBUME11

Lavabo tondo in Cristalmood, disponibile in diversi colori come da nostro campionario, sopraiano o abbinabile con colonna art. ALBUME20 e ALBUME21, completo di piletta con scarico libero e raccordo per sifone.

*Round sink in Cristalmood, available in various colors, top mount or to be combined with pedestal Art. ALBUME20 and ALBUME21 complete with drain pipe fitting and open plug.*

H	Ø	art.
65,5	28	ALBUME21

Colonna da terra in in pietra, disponibile in diversi colori come da nostro campionario, con scarico a pavimento, sifone e tubo flessibile

*Pedestal in stone available in various colors with floor drainage, siphon and flexible hose.*

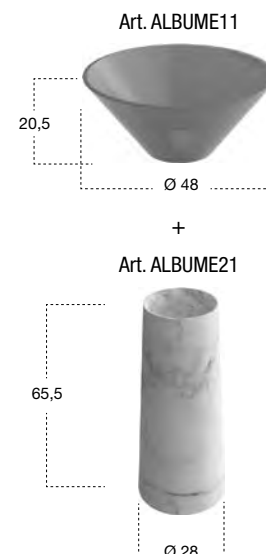

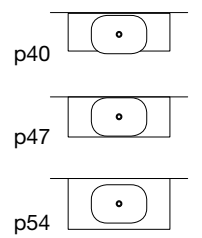

H	P	L	art.
15	40	60	SENSOC

Lavabo rettangolare sopra piano in Cristalmoood, disponibile in diversi colori come da nostro campionario, completo di piletta con scarico libero e raccordo per sifone.

*Rectangular top mount sink in Cristalmoood, available in various colors complete with drain pipe fitting and open plug.*



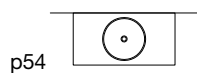
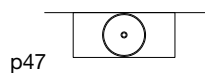

H	Ø	art.
15	43	CATINO43C

Lavabo tondo sopra piano in Cristalmoood, disponibile in diversi colori come da nostro campionario completo di piletta con scarico libero e raccordo per sifone.

*Round top mount sink in Cristalmoood, available in various colors complete with drain pipe fitting and open plug.*

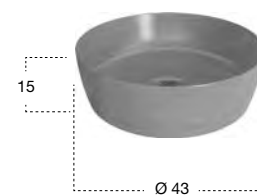



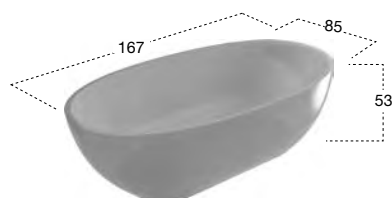

H	P	L	art.
53	85	167	REFLEX

Vasca da bagno ovale in Cristalmood disponibile in diversi colori come da nostro campionario, completa di piletta con sistema di scarico a pressione klik klak, sifone e tubo flessibile.  
 Peso vasca: 150 kg.  
 Capacità: 350 L.

*Oval Cristalmood bathtub available in various colors complete with drain and pressure plug, siphon and flexible hose.  
 Weight: 150 kg.  
 Capacity: 350 L.*





## QUARZOMOOD

Insieme al Flumood, l'innovativo materiale composto per la maggior parte da idrossido di alluminio e resine sintetiche, frutto della ricerca antoniolupi, l'azienda propone dopo due anni di sperimentazioni il Quarzomood che oltre alla grandissima resistenza dovuta all'aggiunta di quarzo, consente nuove cromie. L'azienda ne ha sviluppate tre, denominate Serena, Terra e Seta che permettono ricercati accostamenti dei piani e dei lavabi integrati, sia con le nuove finiture dei mobili, sia con le versioni laccate e uniformi.

Resistentissimo, facile da pulire, ripristinabile agevolmente in caso di graffi, bruciature o dall'usura dell'impiego quotidiano, Quarzomood mantiene inalterate le sue caratteristiche nel tempo e costituisce un altro passo verso quella ricerca della perfezione che caratterizza tutti i prodotti dell'azienda.

*Together with Flumood, the innovative material composed mostly of aluminum hydroxide and synthetic resins a result of the antoniolupi research, the company proposes after two years of experimentation, Quarzomood. The great resistance, due to the addition of quartz, allows for new colors. The company has developed three different colors, Serena, Terra and Seta, which allow refined combinations of integrated surfaces and sinks, both with the new furniture finishes and with the lacquered and uniform versions.*

*Extremely resistant, easy to clean, easily restored in case of scratches, burns or wear and tear of everyday use, Quarzomood maintains its characteristics unchanged over time and represents another step towards the search for perfection that characterizes all the company's products.*



TOP / TOPS



Top in Quarzomood Serena

*Top in Quarzomood Serena*



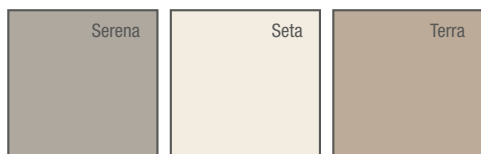

Per collezione / For collection

ATELIER - BESPOKE - PIANA - LUNARIA

H	P	L	art.
1,2	40	da / from 72 a / to 218,4	QM140
	47		QM147
	54		QM154

Per collezione / For collection

PANTA REI

H	P	L	art.
1,2	40	da / from 72 a / to 216	QM240
	47		QM247
	54		QM254

Per collezione / For collection

PLANETA

H	P	L	art.
1,2	40	da / from 72 a / to 216	QM340
	47		QM347
	54		QM354

Top in Quarzomood, spessore 12 mm.

Top in Quarzomood, 12 mm thick.

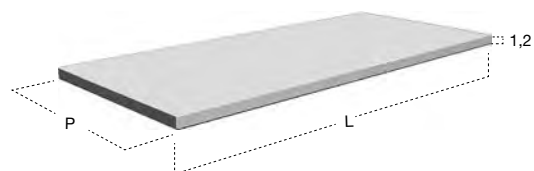



Top in Quarzomood Seta

Top in Quarzomood Seta

# NIDOQ

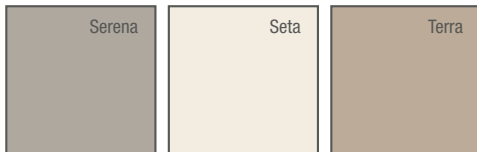

OPTIONAL NIDOQ  
Pianetto copripiletta  
Cover plate

Art. PIANETTOQ1

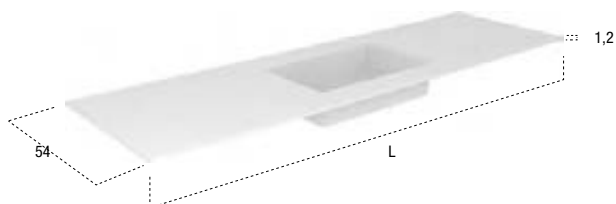
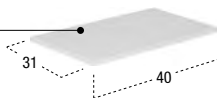

Per collezione / For collection

ATELIER - BESPOKE - PIANA - LUNARIA

art.

H	P	L
1,2	54	da / from 72 a / to 218,4

NIDOQ172

Per collezione / For collection

PANTA REI

art.

H	P	L
1,2	54	da / from 72 a / to 216

NIDOQ272

Per collezione / For collection

PLANETA

art.

H	P	L
1,2	54	da / from 72 a / to 216

NIDOQ372

Top con lavabo integrato in Quarzomood completo di piletta con scarico libero e raccordo per sifone, disponibile in diversi colori come da nostro campionario  
N.B. solo per porta lavabi H 37,5 e H 50 cm. Nei porta lavabi H 37,5 è possibile inserire solo sifone art. MICRO.

*Top with integrated sink in Quarzomood complete with drain pipe fitting and plug, in various colours as per our samples  
P.S. only for sink units cm 37,5 and 50 H. In sink units cm 37,5 H it is only possible to use siphon art. MICRO.*



Top in Quarzomood Terra

*Top in Quarzomood Terra*



# NUVOLAQ

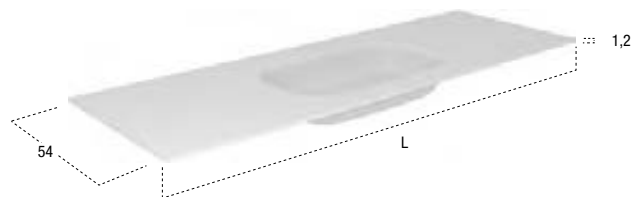
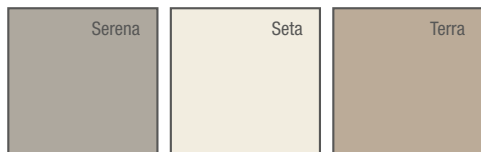

Per collezione / For collection

ATELIER - BESPOKE - PIANA - LUNARIA

H	P	L
1,2	54	da / from 90 a / to 218,4

art.

NUVQ190

Per collezione / For collection

PANTA REI

H	P	L
1,2	54	da / from 90 a / to 216

art.

NUVQ290

Per collezione / For collection

PLANETA

H	P	L
1,2	54	da / from 90 a / to 216

art.

NUVQ390

Top con lavabo integrato in Quarzomood completo di piletta con scarico libero e raccordo per sifone, disponibile in diversi colori come da nostro campionario  
 N.B. solo per porta lavabi H 37,5 e H 50 cm. Nei porta lavabi H 37,5 è possibile inserire solo sifone art. MICRO.

*Top with integrated sink in Quarzomood complete with drain pipe fitting and plug, in various colours as per our samples  
 P.S. only for sink units cm 37,5 and 50 H. In sink units cm 37,5 H it is only possible to use siphon art. MICRO.*



Top in Quarzomood Terra

Top in Quarzomood Terra

## FLUMOOD

Corian nel 2001, il Cristalplant nel 2004 e poi ancora il Ceramilux... ora il Flumood, un materiale di nuova generazione brevetto e proprietà di antoniolupi. Dalla ricerca dell'azienda è nato Flumood, un nuovo materiale brevettato e di proprietà, ecologico, compatto, non poroso e atossico, con una superficie facilmente pulibile con i comuni detergenti per la pulizia domestica e ripristinabile in caso di graffi o segni derivanti dall'uso quotidiano. Perfetto per l'ambiente bagno Flumood è in grado di associare alla notevole resistenza una presenza estetica di notevole impatto ma anche un'estrema piacevolezza al tatto, che lo fanno preferire sia per la realizzazione di lavabi ma anche per piani d'appoggio di qualsiasi dimensione e forma. Proprio l'aspetto materico è una delle sue caratteristiche vincenti. Può essere infatti proposto sia nella finitura Satin che in quella Texture, caratterizzata da un effetto "raw" simile a quello di una pietra a spacco. Oggi il nuovo materiale viene proposto su alcune nuove collezioni ma la sua diffusione nell'ambito della gamma di proposte è rapida e concreta. A partire da Simplo disegnato da Mario Ferrarini, sia nella versione freestanding che da appoggio, per proseguire con Fusto di Nevio Tellatin ma anche con le proposte, sempre dedicate al mondo del lavabo, Calco e Senso. La versatilità del Flumood permette di realizzare qualsiasi forma, di esplorare nuovi territori, di interpretare esigenze diverse.



## FLUMOOD

*Corian in 2001, Cristalplant in 2004 and then Ceramilux... now Flumood, a next-generation material and patent owned by antoniolupi. From company research Flumood was born, a new patented and owned material, eco-friendly, compact, non-porous and non-toxic, with an easily cleanable surface and recoverable in case of scratches or marks derived from daily use.*

*Flumood is perfect for the bathroom environment with a considerable resistance and strong aesthetic impact, extremely pleasant to the touch referred for the construction of basins but also for tops of any size and shape. Just the material aspect is one of its winning features. It can be in fact proposed in both the Satin or Texture finish, characterized by a "raw" effect similar to that of a split stone. Today, this new material is offered on new collections but diffused within the proposed range. From Simplo designed by Mario Ferrarini, both the freestanding version and the top mounted sink, followed by Fusto, Nevio Tellatin and sinks, Calco and Senso. The versatility of Flumood allows to create any form, to break new ground, to interpret different needs.*

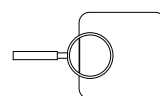

ANTIBATTERICO  
ATOSSICO  
ANTIBACTERIAL  
NON TOXIC

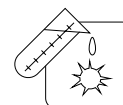

RESISTENTE ALLE  
SOSTANZE CHIMICHE  
RESISTANT TO  
CHEMICALS



IGNIFUGO  
FIREPROOF



VERNICIABILE  
PAINTABLE

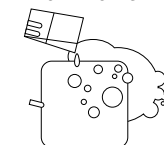

IDROREPELLENTE  
WATER REPELLENT

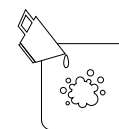

ANTIMACCHIA  
STAIN RESISTANT

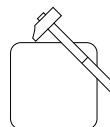

SOLIDO  
SOLID



ECOLOGICO  
ECOLOGICAL

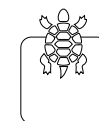

LUNGA DURATA  
LONG LIFE

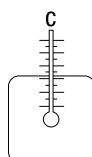

RESISTENTE ALLE  
VARIAZIONI DI TEMPERATURA  
RESISTANT TO VARIATIONS  
IN TEMPERATURE

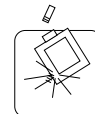

OTTIMA RESISTENZA AI GRAFFI  
E ALLE ABRASIONI  
EXCELLENT RESISTANCE TO  
SCRATCHES AND ABRASIONS



CARTEGGIABILE  
COME IL LEGNO  
SAND LIKE WOOD







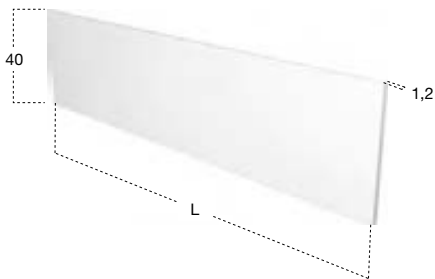

H	P	L	art.
40	1,2	da / from 54 a / to 272,4	BC140

Alzatina in Flumood in finitura Satin o Texture.

*Flumood backsplash in Satin or Texture finish.*



Per collezione / For collection

ATELIER - BESPOKE - PIANA - LUNARIA

H	P	L	art.
1,2	40	da / from 54 a / to 272,4	BC140
	47		BC147
	54		BC154

Per collezione / For collection

PANTA REI

H	P	L	art.
1,2	40	da / from 54 a / to 216	BC240
	47		BC247
	54		BC254

Per collezione / For collection

PLANETA

H	P	L	art.
1,2	40	da / from 54 a / to 216	BC340
	47		BC347
	54		BC354

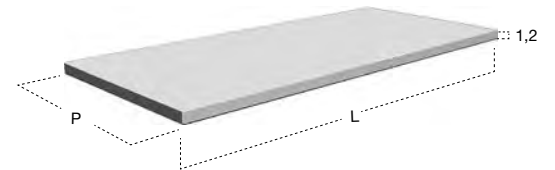

Top in Flumood finitura Satin o Texture, spessore 12 mm.

Top in Flumood Satin or Texture finish, 12 mm thick.





Per collezione / For collection				
ATELIER - BESPOKE - PIANA - LUNARIA				
H	P	L	art.	
1,2	47	da / from 72	a / to 272,4	BC147 + BASIC047
	54			BC154 + BASIC054

Per collezione / For collection				
PANTA REI				
H	P	L	art.	
1,2	47	da / from 72	a / to 216	BC247 + BASIC047
	54			BC254 + BASIC054

Per collezione / For collection				
PLANETA				
H	P	L	art.	
1,2	47	da / from 72	a / to 216	BC347 + BASIC047
	54			BC354 + BASIC054

Top con lavabo integrato in Flumood in finitura Satin, spessore 12 mm completo di piletta con scarico libero e raccordo per sifone.

N.B. solo per porta lavabi H 37,5 e H 50 cm. Nei porta lavabi H 37,5 è possibile inserire solo sifone art. MICRO.

*Top with integrated sink in Flumood Satin finish, 12 mm thick, complete with drain pipe fitting and open plug.*

*P.S. only for sink units cm 37,5 and 50 H. In sink units cm 37,5 H it is only possible to use siphon art. MICRO.*

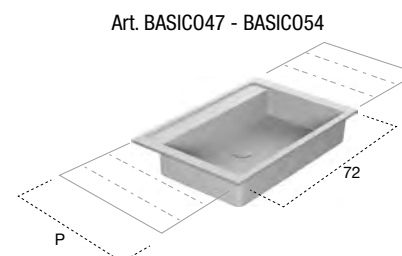

Art. BASIC047 - BASIC054

+

Art. BC147 - BC247 - BC347  
Art. BC154 - BC254 - BC354

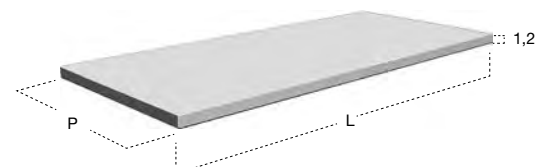







Per collezione / For collection				
ATELIER - BESPOKE - PIANA - LUNARIA				
H	P	L	art.	
1,2	47	da / from 144	a / to 272,4	BC147 + n° 2 BASIC047
	54			BC154 + n° 2 BASIC054

Per collezione / For collection				
PANTA REI				
H	P	L	art.	
1,2	47	da / from 144	a / to 216	BC247 + n° 2 BASIC047
	54			BC254 + n° 2 BASIC054

Per collezione / For collection				
PLANETA				
H	P	L	art.	
1,2	47	da / from 144	a / to 216	BC347 + n° 2 BASIC047
	54			BC354 + n° 2 BASIC054

Top con doppio lavabo integrato in Flumood finitura Satin, spessore 12 mm, completo di piletta con scarico libero e raccordo per sifone.

N.B. solo per porta lavabi H 37,5 e H 50 cm. Nei porta lavabi H 37,5 è possibile inserire solo sifone art. MICRO.

*Top with double integrated sink in Flumood Satin finish, 12 mm thick, with drain pipe fitting and open plug.*

*P.S. only for sink units cm 37,5 and 50 H. In sink units cm 37,5 H it is only possible to use siphon art. MICRO.*

Art. BASIC047 - BASIC054

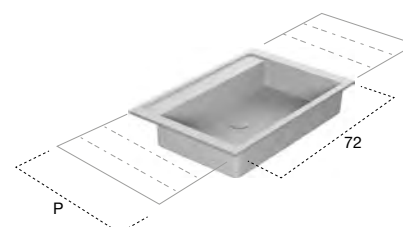

+

Art. BC147 - BC247 - BC347  
Art. BC154 - BC254 - BC354

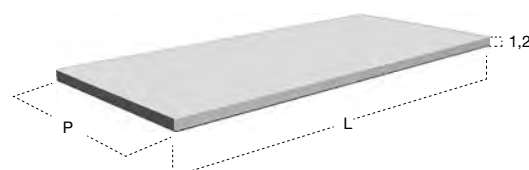





Per collezione / For collection

**ATELIER - BESPOKE - PIANA - LUNARIA**

art.

H	P	L			art.
1,2	54	da / from 54	a / to 272,4		BC154 + NIDO54
	54	da / from 108	a / to 272,4		BC154 + n° 2 NIDO54

Per collezione / For collection

**PANTA REI**

art.

H	P	L			art.
1,2	54	da / from 54	a / to 216		BC254 + NIDO54
	54	da / from 108	a / to 216		BC254 + n° 2 NIDO54

Per collezione / For collection

**PLANETA**

art.

H	P	L			art.
1,2	54	da / from 54	a / to 216		BC354 + NIDO54
	54	da / from 108	a / to 216		BC354 + n° 2 NIDO54

Top con singolo o doppio lavabo integrato in Flumood spessore 12 mm finitura Satin, completo di piletta con scarico libero e raccordo per sifone.

N.B. solo per porta lavabi H 37,5 e H 50 cm. Nei porta lavabi H 37,5 è possibile inserire solo sifone art. MICRO.

Top with single or double integrated sink in Flumood Satin finish 12 mm thick, with drain pipe fitting and open plug.

P.S. only for sink units cm 37,5 and 50 H. In sink units cm 37,5 H it is only possible to use siphon art. MICRO.

OPTIONAL NIDO54  
Pianetto copripiletta  
Cover plate

Art. PIANETTO1

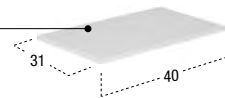

Art. NIDO54

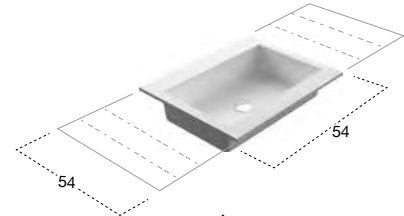

Art. BC154 - BC254 - BC354

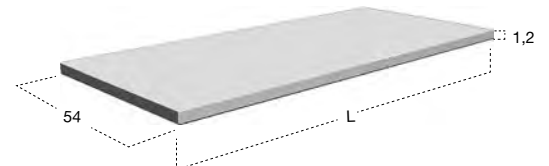





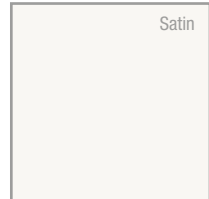

Per collezione / For collection

**ATELIER - BESPOKE - PIANA - LUNARIA**

art.

H	P	L			art.
1,2	54	da / from 72	a / to 272,4		BC154 + NIDO
	54	da / from 144	a / to 272,4		BC154 + n° 2 NIDO

Per collezione / For collection

**PANTA REI**

art.

H	P	L			art.
1,2	54	da / from 72	a / to 216		BC254 + NIDO
	54	da / from 144	a / to 216		BC254 + n° 2 NIDO

Per collezione / For collection

**PLANETA**

art.

H	P	L			art.
1,2	54	da / from 72	a / to 216		BC354 + NIDO
	54	da / from 144	a / to 216		BC354 + n° 2 NIDO

Top con singolo o doppio lavabo integrato in Flumood spessore 12 mm finitura Satin, completo di piletta con scarico libero e raccordo per sifone.

N.B. solo per porta lavabi H 37,5 e H 50 cm. Nei porta lavabi H 37,5 è possibile inserire solo sifone art. MICRO.

Top with single or double integrated sink in Flumood Satin finish 12 mm thick, with drain pipe fitting and open plug.

P.S. only for sink units cm 37,5 and 50 H. In sink units cm 37,5 H it is only possible to use siphon art. MICRO.

OPTIONAL NIDO  
Pianetto copripiletta  
Cover plate

Art. PIANETTO2

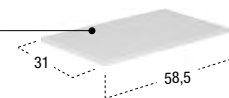

Art. NIDO

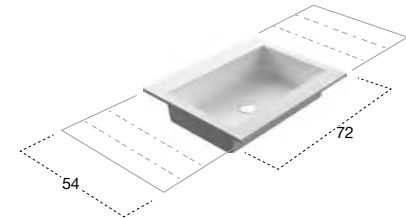

+

Art. BC154 - BC254 - BC354

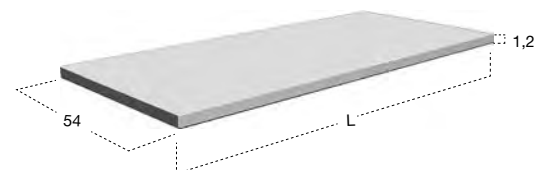

NUVOLA design Nevio Tellatin





Per collezione / For collection

**ATELIER - BESPOKE - PIANA - LUNARIA**

art.

H	P	L			art.
1,2	54	da / from 72	a / to 272,4		BC154 + NUVOLA
	54	da / from 144	a / to 272,4		BC154 + n° 2 NUVOLA

Per collezione / For collection

**PANTA REI**

art.

H	P	L			art.
1,2	54	da / from 72	a / to 216		BC254 + NUVOLA
	54	da / from 144	a / to 216		BC254 + n° 2 NUVOLA

Per collezione / For collection

**PLANETA**

art.

H	P	L			art.
1,2	54	da / from 72	a / to 216		BC354 + NUVOLA
	54	da / from 144	a / to 216		BC354 + n° 2 NUVOLA

Top con singolo o doppio lavabo integrato in Flumood spessore 12 mm finitura Satin, completo di piletta con scarico libero e raccordo per sifone.

N.B. solo per porta lavabi H 37,5 e H 50 cm. Nei porta lavabi H 37,5 è possibile inserire solo sifone art. MICRO.

*Top with single or double integrated sink in Flumood Satin finish 12 mm thick, with drain pipe fitting and open plug.*

*P.S. only for sink units cm 37,5 and 50 H. In sink units cm 37,5 H it is only possible to use siphon art. MICRO.*

Art. NUVOLA

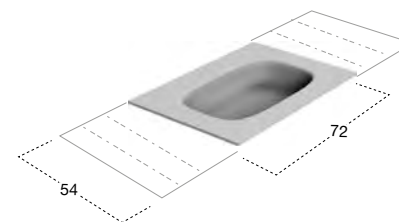

+

Art. BC154 - BC254 - BC354

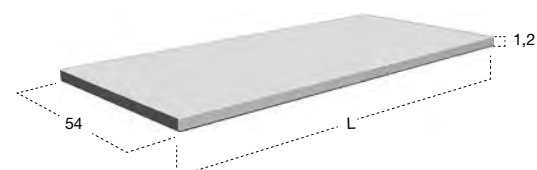



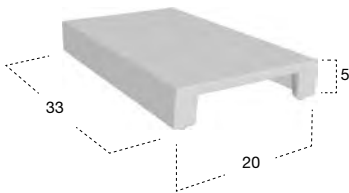

H	P	L	art.
5	33	20	PIANETTO

Pianetto optional copripiletta in Flumood finitura Satin.

*Optional Flumood drain cover in satin finish.*



Per collezione / For collection					
ATELIER - BESPOKE - PIANA - LUNARIA					
H	P	L	art.		
1,2	54	da / from 108	a / to 272,4	BC154 + PODIO	

Per collezione / For collection					
PANTA REI					
H	P	L	art.		
1,2	54	da / from 108	a / to 216	BC254 + PODIO	

Per collezione / For collection					
PLANETA					
H	P	L	art.		
1,2	54	da / from 108	a / to 216	BC354 + PODIO	

Top con lavabo integrato in Flumood finitura Satin o Texture, spessore 12 mm completo di piletta con scarico libero e raccordo per sifone.

N.B. solo per porta lavabi H 37,5 e H 50 cm. Nei porta lavabi H 37,5 è possibile inserire solo sifone art. MICRO.

*Top with integrated sink in Flumood Satin or Texture finish, 12 mm thick, complete with drain pipe fitting and open plug.*

*P.S. only for sink units cm 37,5 and 50 H. In sink units cm 37,5 H it is only possible to use siphon art. MICRO.*

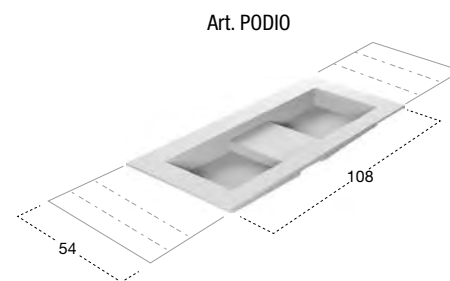

+

Art. BC154 - BC254 - BC354

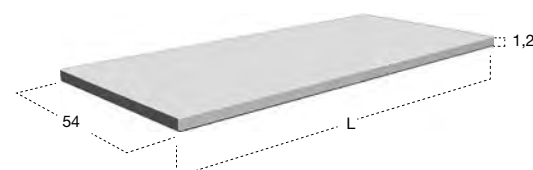





H	P	L	art.	
12,5	40	da / from 72	a / to 272,4	BCS40
	47			BCS47
	54			BCS54

Top scatolare in Flumood in finitura Satin o Texture, spessore 125 mm.

*Suspended Flumood top in Satin or Texture finish, 125 mm thick.*

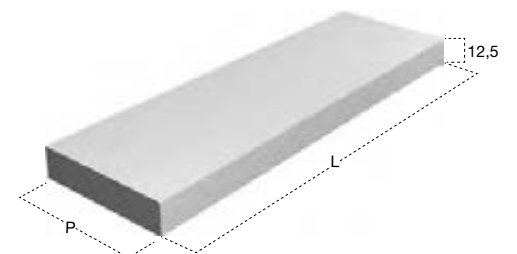



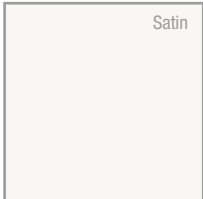

Art. BASIC047 - BASIC054

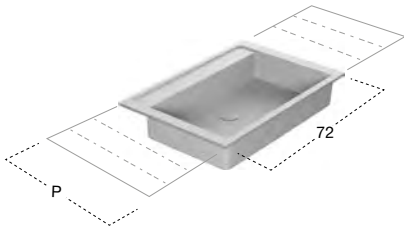

+

Art. BCS47 - BCS54

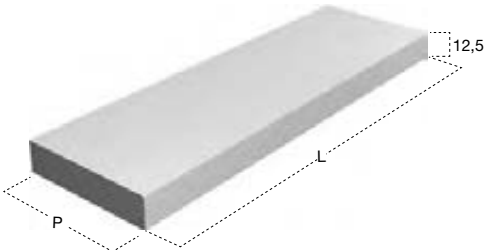

H	P	L	art.	
12,5	47	da / from 72	a / to 272,4	BCS47 + BASIC047
	54			BCS54 + BASIC054

Top con lavabo integrato in Flumood finitura Satin, spessore 125 mm, completo di piletta con scarico libero e raccordo per sifone.

Top with integrated sink in Flumood Satin finish 125 mm thick, complete with drain pipe fitting and open plug.



Art. BASIC047 - BASIC054

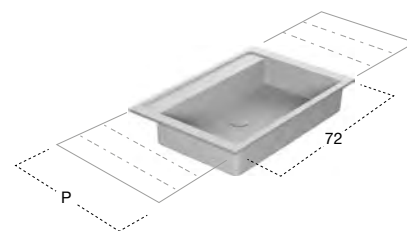

+

Art. BCS47 - BCS54

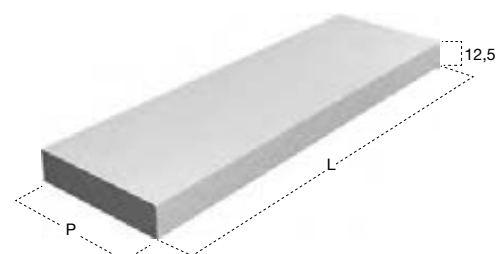

H	P	L	art.	
12,5	47	da / from 144	a / to 272,4	BCS47 + n° 2 BASIC047
	54			BCS54 + n° 2 BASIC054

Top con doppio lavabo integrato in Flumood finitura Satin spessore 125 mm, completo di piletta con scarico libero e raccordo per sifone.

*Top with double integrated sink in Flumood Satin finish 125 mm thick, complete with drain pipe fitting and open plug.*

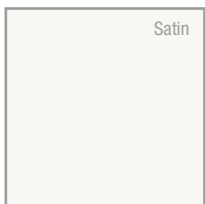

Art. NID054

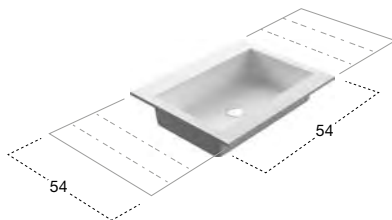

+

Art. BCS54

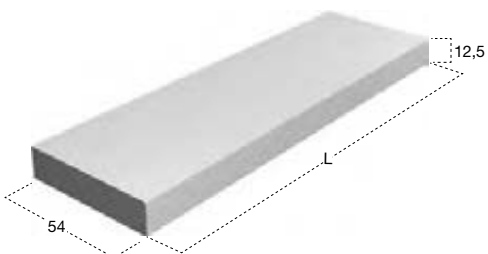

OPTIONAL NID054  
Pianetto copripiletta  
Cover plate

Art. PIANETTO1

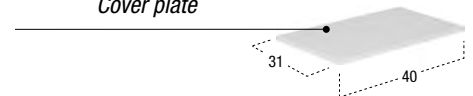

H	P	L			art.
12,5	54	da / from 54	a / to 272,4		BCS54 + NID054
		54	da / from 108	a / to 272,4	BCS54 + n° 2 NID054

Top con singolo o doppio lavabo integrato in Flumood finitura Satin spessore 125 mm, completo di piletta con scarico libero e raccordo per sifone.

Top with single or double integrated sink in Flumood Satin finish 125 mm thick, complete with drain pipe fitting and open plug.

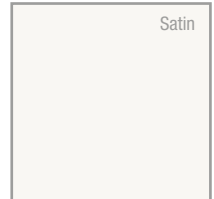

OPTIONAL NIDO  
Pianetto copripiletta  
Cover plate

Art. PIANETTO2

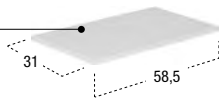

Art. NIDO

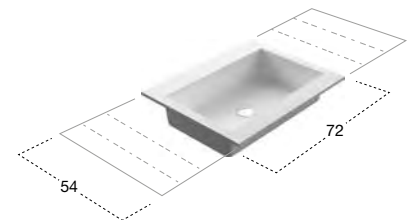

+

Art. BCS54

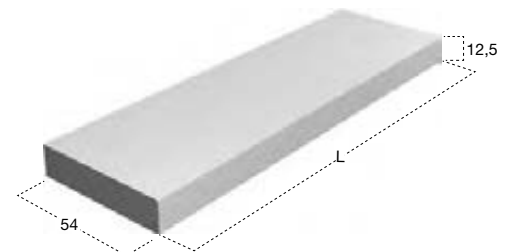

H	P	L	art.	
12,5	54	da / from 72	a / to 272,4	BCS54 + NIDO
	54	da / from 144	a / to 272,4	BCS54 + n° 2 NIDO

Top con singolo o doppio lavabo integrato in Flumood finitura Satin spessore 125 mm, completo di piletta con scarico libero e raccordo per sifone.

Top with single or double integrated sink in Flumood Satin finish 125 mm thick, complete with drain pipe fitting and open plug.









Art. NUVOLA

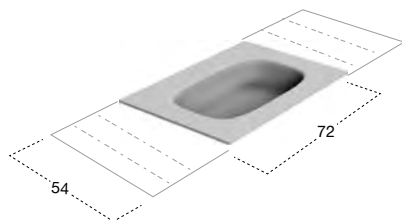

+

Art. BCS54

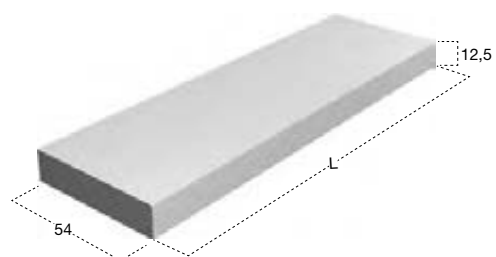

H	P	L			art.
12,5	54	da / from 72	a / to 272,4		BCS54 + NUVOLA
	54	da / from 144	a / to 272,4		BCS54 + n° 2 NUVOLA

Top con singolo o doppio lavabo integrato in Flumood finitura Satin spessore 125 mm, completo di pileta con scarico libero e raccordo per sifone.

Top with single or double integrated sink in Flumood Satin finish 125 mm thick, complete with drain pipe fitting and open plug.



H	P	L	art.
5	33	20	PIANETTO

Pianetto optional copripiletta in Flumood finitura Satin.

*Optional Flumood drain cover in satin finish.*

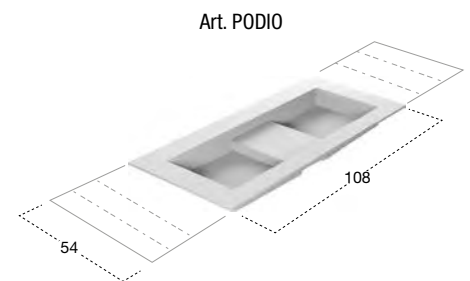
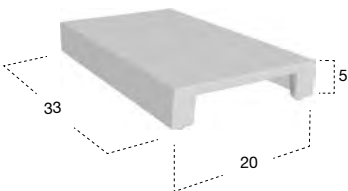

+

Art. BCS54

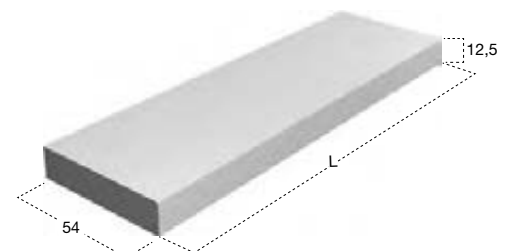

H	P	L	art.
12,5	54	da / from 108 a / to 272,4	BCS54 + PODIO

Top con lavabo integrato in Flumood finitura Satin o Texture, spessore 125 mm, completo di piletta con scarico libero e raccordo per sifone.

*Top with integrated sink in Flumood Satin or Texture finish, 125 mm thick complete with drain pipe fitting and open plug which may be wall mounted or used on furniture.*







Per collezione / For collection

ATELIER - BESPOKE - PIANA - LUNARIA

art.

H	P	L		art.
1,2	54	da / from 72	a / to 299,4	CR154 + OPENSLOT72
	54	da / from 90	a / to 299,4	CR154 + OPENSLOT90
	54	da / from 108	a / to 299,4	CR154 + OPENSLOT108

Per collezione / For collection

PANTA REI

art.

H	P	L		art.
1,2	54	da / from 72	a / to 216	CR254 + OPENSLOT72
	54	da / from 90	a / to 216	CR254 + OPENSLOT90
	54	da / from 108	a / to 216	CR254 + OPENSLOT108

Per collezione / For collection

PLANETA

art.

H	P	L		art.
1,2	54	da / from 72	a / to 216	CR354 + OPENSLOT72
	54	da / from 90	a / to 216	CR354 + OPENSLOT90
	54	da / from 108	a / to 216	CR354 + OPENSLOT108

Top con lavabo integrato in Corian spessore 12 mm, completo di piletta con scarico libero e raccordo per sifone.

N.B. solo per porta lavabi H 37,5 e H 50 cm. Nei porta lavabi H 37,5 è possibile inserire solo sifone art. MICRO. Solo per rubinetteria a parete.

Top with integrated sink completely in Corian 12 mm thick, with drain pipe fitting and open plug.  
P.S. only for sink units cm 37,5 and 50 H. In sink units cm 37,5 H it is only possible to use siphon art. MICRO. Only for wall mount tap.

Art. OPENSLOT72 - OPENSLOT90 - OPENSLOT108

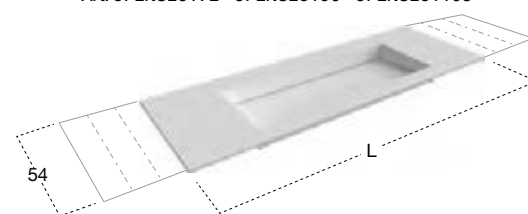

+

Art. CR154 - CR254 - CR354

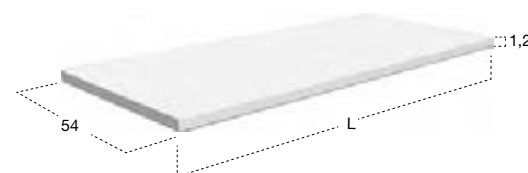



Per collezione / For collection

ATELIER - BESPOKE - PIANA - LUNARIA

H	P	L		art.
1,2	40	da / from 27	a / to 299,4	CR140
	54			CR154

Per collezione / For collection

PANTA REI

H	P	L		art.
1,2	40	da / from 36	a / to 216	CR240
	54			CR254

Per collezione / For collection

PLANETA

H	P	L		art.
1,2	40	da / from 27	a / to 216	CR340
	54			CR354

Top o alzatina in Corian spessore 12 mm.

Top or backsplash in Corian 12 mm thick.

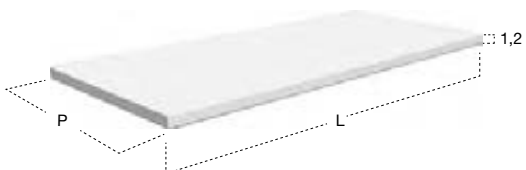



Per collezione / For collection				
PIANA - LUNARIA				
H	P	L		art.
1,2	40	da / from 72	a / to 299,4	CR140 + MYSLOT472
	40	da / from 90	a / to 299,4	CR140 + MYSLOT490
Per collezione / For collection				
PANTA REI				
H	P	L		art.
1,2	40	da / from 72	a / to 216	CR240 + MYSLOT472
	40	da / from 90	a / to 216	CR240 + MYSLOT490
Per collezione / For collection				
PLANETA				
H	P	L		art.
1,2	40	da / from 72	a / to 216	CR340 + MYSLOT472
	40	da / from 90	a / to 216	CR340 + MYSLOT490

Top con lavabo integrato in Corian spessore 12 mm, con sistema di scarico predisposto per sifone.  
 N.B. solo per porta lavabi H 37,5 e H 50 cm. Nei porta lavabi H 37,5 è possibile inserire solo sifone art.  
 MICRO. Solo per rubinetteria a parete.

*Top with integrated sink completely in Corian 12 mm thick, with drain prepared for siphon.  
 N.B. only for sink units cm 37,5 and 50 H. In sink units cm 37,5 H it is only possible to use siphon art.  
 MICRO. Only for wall mount tap.*

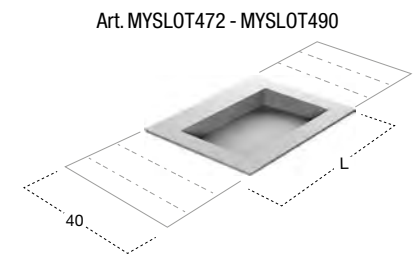

+

Art. CR140 - CR240 - CR340

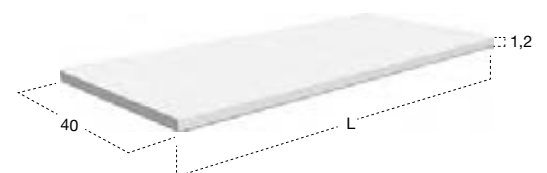





Art. MYSLOT72 - MYSLOT90

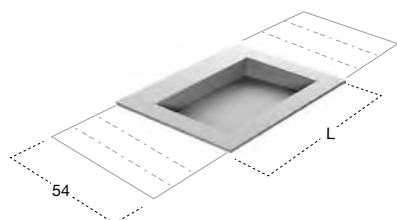

+

Art. CR154 - CR254 - CR354

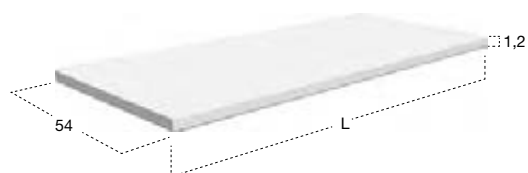

Per collezione / For collection

ATELIER - BESPOKE - PIANA - LUNARIA

H	P	L		art.
1,2	54	da / from 72	a / to 299,4	CR154 + MYSLOT72
	54	da / from 90	a / to 299,4	CR154 + MYSLOT90

Per collezione / For collection

PANTA REI

H	P	L		art.
1,2	54	da / from 72	a / to 216	CR254 + MYSLOT72
	54	da / from 90	a / to 216	CR254 + MYSLOT90

Per collezione / For collection

PLANETA

H	P	L		art.
1,2	54	da / from 72	a / to 216	CR354 + MYSLOT72
	54	da / from 90	a / to 216	CR354 + MYSLOT90

Top con lavabo integrato in Corian spessore 12 mm, con sistema di scarico predisposto per sifone.  
N.B. solo per porta lavabi H 37,5 e H 50 cm. Nei porta lavabi H 37,5 è possibile inserire solo sifone art. MICRO.

*Top with integrated sink completely in Corian 12 mm thick, with drain prepared for siphon.  
P.S. only for sink units cm 37,5 and 50 H. In sink units cm 37,5 H it is only possible to use siphon art. MICRO.*



Per collezione / For collection				
ATELIER - BESPOKE - PIANA - LUNARIA				
H	P	L	art.	
1,2	54	da / from 144	a / to 299,4	CR154 + n° 2 MY SLOT72

Per collezione / For collection				
PANTA REI				
H	P	L	art.	
1,2	54	da / from 144	a / to 216	CR254 + n° 2 MY SLOT72

Per collezione / For collection				
PLANETA				
H	P	L	art.	
1,2	54	da / from 144	a / to 216	CR354 + n° 2 MY SLOT72

Top con doppio lavabo integrato in Corian spessore 12 mm, con sistema di scarico predisposto per sifone.

N.B. solo per porta lavabi H 37,5 e H 50 cm. Nei porta lavabi H 37,5 è possibile inserire solo sifone art. MICRO.

*Top with double integrated sink completely in Corian 12 mm thick, with drain prepared for siphon.  
P.S. only for sink units cm 37,5 and 50 H. In sink units cm 37,5 H it is only possible to use siphon art. MICRO.*

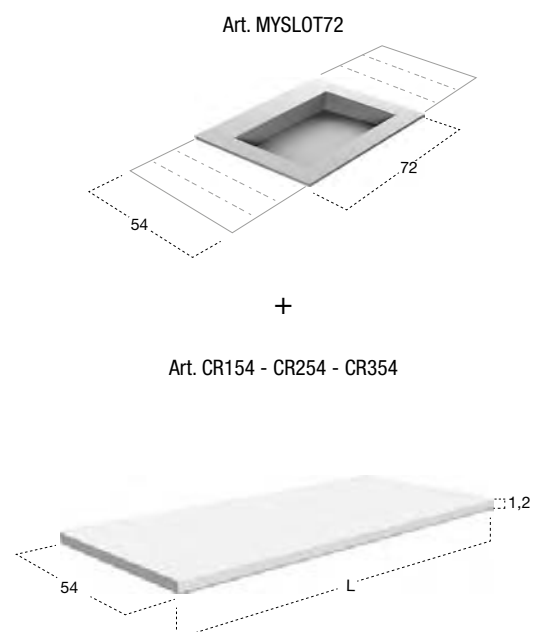



Art. SEGNO72 - SEGNO90

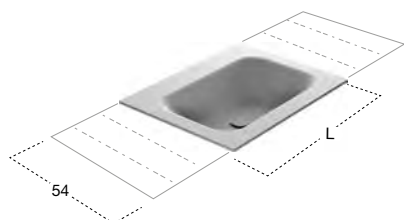

+

Art. CR154 - CR254 - CR354

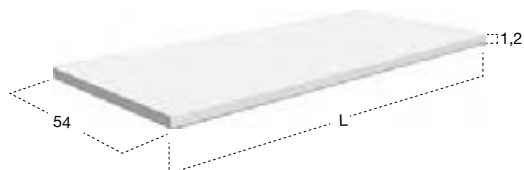

Per collezione / For collection

ATELIER - BESPOKE - PIANA - LUNARIA

art.

H	P	L			
1,2	54	da / from 72	a / to 299,4	CR154 + SEGNO72	
	54	da / from 90	a / to 299,4	CR154 + SEGNO90	

Per collezione / For collection

PANTA REI

art.

H	P	L			
1,2	54	da / from 72	a / to 216	CR254 + SEGNO72	
	54	da / from 90	a / to 216	CR254 + SEGNO90	

Per collezione / For collection

PLANETA

art.

H	P	L			
1,2	54	da / from 72	a / to 216	CR354 + SEGNO72	
	54	da / from 90	a / to 216	CR354 + SEGNO90	

Top con lavabo integrato in Corian spessore 12 mm, completo di piletta con scarico libero e raccordo per sifone.  
N.B. solo per porta lavabi H 37,5 e H 50 cm. Nei porta lavabi H 37,5 è possibile inserire solo sifone art. MICRO.

*Top with integrated sink completely in Corian 12 mm thick, with drain pipe fitting and open plug.  
P.S. only for sink units cm 37,5 and 50 H. In sink units cm 37,5 H it is only possible to use siphon art. MICRO.*



Per collezione / For collection					
ATELIER - BESPOKE - PIANA - LUNARIA					
H	P	L	art.		
1,2	54	da / from 144	a / to 299,4	CR154 + n° 2 SEGNO72	

Per collezione / For collection					
PANTA REI					
H	P	L	art.		
1,2	54	da / from 144	a / to 216	CR254 + n° 2 SEGNO72	

Per collezione / For collection					
PLANETA					
H	P	L	art.		
1,2	54	da / from 144	a / to 216	CR354 + n° 2 SEGNO72	

Top con doppio lavabo integrato in Corian spessore 12 mm, completo di piletta con scarico libero e raccordo per sifone.  
 N.B. solo per porta lavabi H 37,5 e H 50 cm. Nei porta lavabi H 37,5 è possibile inserire solo sifone art. MICRO.

*Top with double integrated sink completely in Corian 12 mm thick, with drain pipe fitting and open plug.  
 P.S. only for sink units cm 37,5 and 50 H. In sink units cm 37,5 H it is only possible to use siphon art. MICRO.*

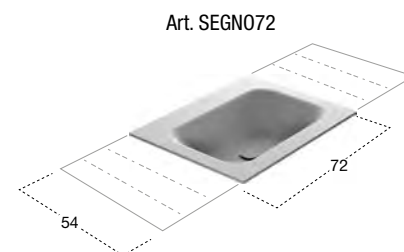

+

Art. CR154 - CR254 - CR354

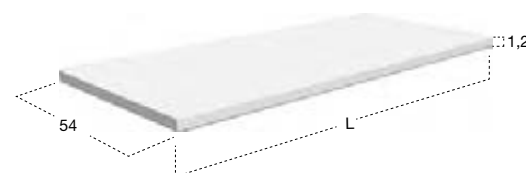







Art. OPENSLOT72 - OPENSLOT90 - OPENSLOT108

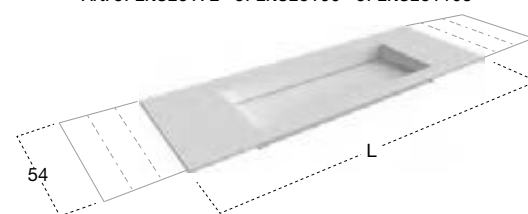

+

Art. CRS54

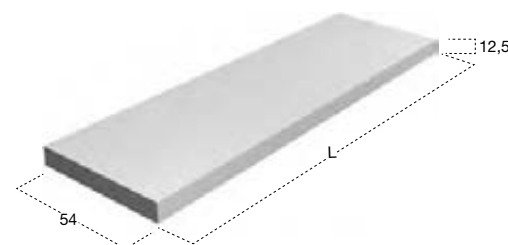

H	P	L			art.
12,5	54	da / from 72	a / to 299,4		CRS54 + OPENSLOT72
	54	da / from 90	a / to 299,4		CRS54 + OPENSLOT90
	54	da / from 108	a / to 299,4		CRS54 + OPENSLOT108

Top con lavabo integrato in Corian spessore 125 mm, completo di piletta con scarico libero e raccordo per sifone.

N.B. solo per rubinetteria a parete.

*Top with integrated sink completely in Corian 125 mm thick complete with drain pipe fitting and open plug which may be wall mounted or used on furniture.*

*P.S. only for wall mount tap.*



Art. MYSLOT472 - MYSLOT490 - MYSLOT72 - MYSLOT90

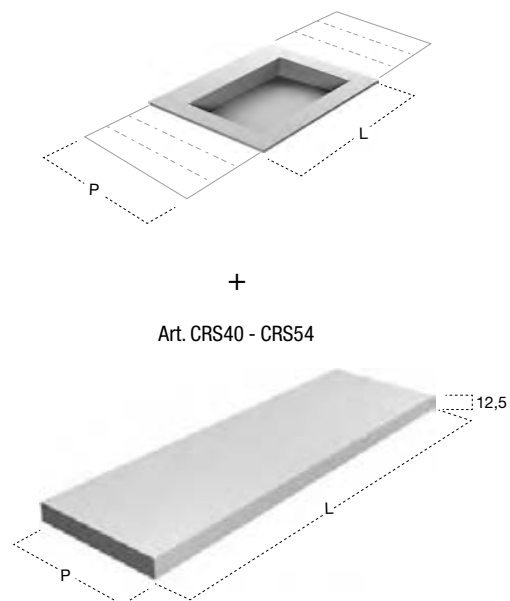

H	P	L			art.
12,5	40	da / from 72	a / to 299,4		CRS40 + MYSLOT472
	40	da / from 90	a / to 299,4		CRS40 + MYSLOT490
H	P	L			art.
12,5	54	da / from 72	a / to 299,4		CRS54 + MYSLOT72
	54	da / from 90	a / to 299,4		CRS54 + MYSLOT90

Top con lavabo integrato in Corian, spess. 125 mm con sistema di scarico predisposto per sifone.

*Top with integrated sink completely in Corian 125 mm thick with drain prepared for siphon that can be wall mounted or used on furniture.*



Art. MYSL0T72

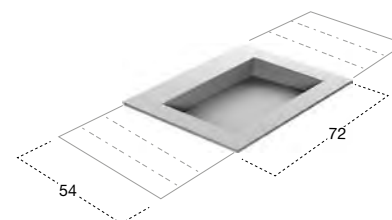

+

Art. CRS54

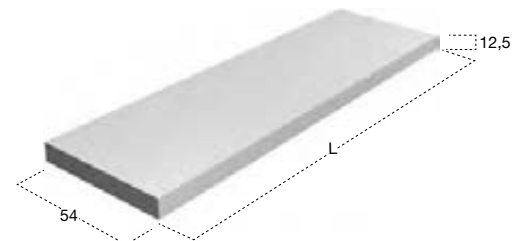

H	P	L	art.	
12,5	54	da / from 144	a / to 299,4	CRS54 + n° 2 MYSL0T72

Top con doppio lavabo integrato in Corian, spess. 125 mm con sistema di scarico predisposto per sifone.

Top with double integrated sinks completely in Corian 125 mm thick with drain prepared for siphon that can be wall mounted or used on furniture.





Art. SEGN072 - SEGN090

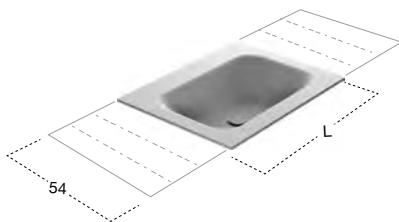

+

Art. CRS54

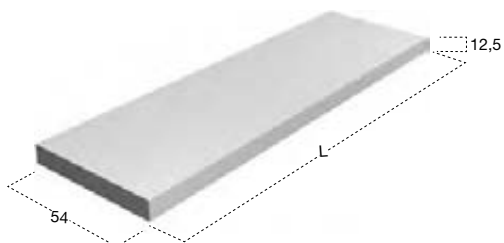

H	P	L			art.
12,5	54	da / from 72	a / to 299,4		CRS54 + SEGN072
	54	da / from 90	a / to 299,4		CRS54 + SEGN090

Top con lavabo integrato in Corian spessore 125 mm, completo di piletta con scarico libero e raccordo per sifone.

Top with integrated sink completely in Corian 125 mm thick complete with drain pipe fitting and open plug which may be wall mounted or used on furniture.



Art. SEGN072 - SEGN090

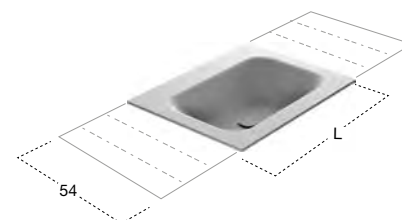

+

Art. CRS54

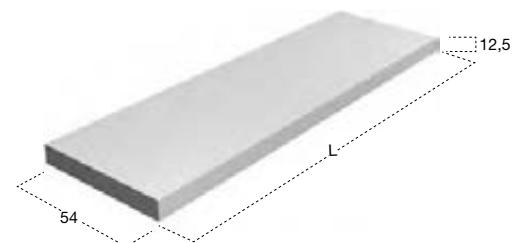

H	P	L			art.
12,5	54	da / from 144	a / to 299,4		CRS54 + n° 2 SEGN072
	54	da / from 180	a / to 299,4		CRS54 + n° 2 SEGN090

Top con doppio lavabo integrato in Corian spessore 125 mm, completo di piletta con scarico libero e raccordo per sifone.

Top with double integrated sink completely in Corian 125 mm thick complete with drain pipe fitting and open plug which may be wall mounted or used on furniture.





rovere thermo

I top scatolati sono realizzati con multistrato di betulla finlandese ad incollaggio fenolico con impiallacciatura in Rovere Evaporato spazzolato 4 mm e in Rovere Thermo o Noce Canaletto in 6 decimi.

*Boxy tops are made of Finnish Birch plywood with phenolic adhesives veneered with 4 mm Rovere Evaporato and 6-tenths Rovere Thermo or Noce Canaletto.*

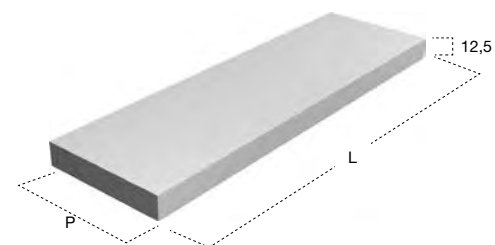

H	P	L	art.
12,5	40	da / from 54 a / to 299,4	BANCO140
	47		BANCO147
	54		BANCO154

Top scatolare in legno spessore 125 mm.

*Suspended wood top, 125 mm thick.*



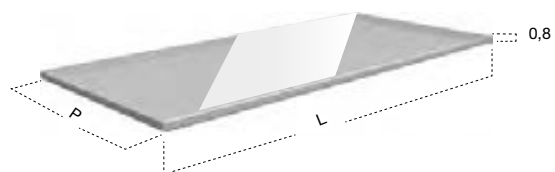

Per collezione / For collection

ATELIER - BESPOKE - PANTA REI - PLANETA - LUNARIA

H	P	L	art.
0,8	40	da / from 27 a / to 218,4	PT3
	47		PT8
	54		PT4

Per collezione / For collection

PIANA

H	P	L	art.
0,8	40	da / from 38,4 a / to 218,4	IT1
	47		IT5
	54		IT2

Top in vetro spessore 8 mm, verniciabile in tutti i colori del nostro campionario.

Glass top 8 mm thick, can be lacquered in all colors of our collection.



Per collezione / For collection				
ATELIER - BESPOKE - PIANA - LUNARIA				
H	P	L		art.
1,2	40	da / from 27	a / to 218,4	919
	47			947
	54			910

Per collezione / For collection				
PANTA REI				
H	P	L		art.
1,2	40	da / from 36	a / to 216	PT1
	47			PT9
	54			PT2

Per collezione / For collection				
PLANETA				
H	P	L		art.
1,2	40	da / from 27	a / to 216	LT1
	47			LT3
	54			LT2

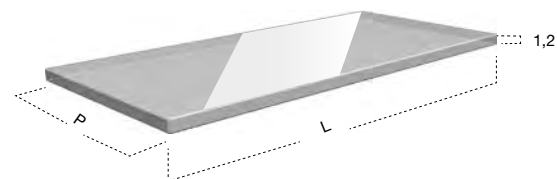

Top in vetro spessore 12 mm, verniciabile in tutti i colori del nostro campionario.

Glass top 12 mm thick, can be lacquered in all colors of our collection



Per collezione / For collection				
ATELIER - BESPOKE - PIANA - LUNARIA				
H	P	L	art.	
1,2	47	da / from 72	a / to	218,4
947 + SOAP4772				

Per collezione / For collection				
PANTA REI				
H	P	L	art.	
1,2	47	da / from 72	a / to	216
PT9 + SOAP4772				

Per collezione / For collection				
PLANETA				
H	P	L	art.	
1,2	47	da / from 72	a / to	216
LT3 + SOAP4772				

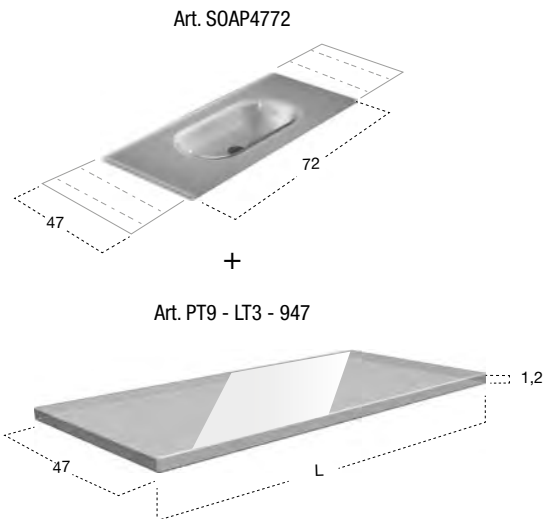

Per collezione / For collection				
ATELIER - BESPOKE - PIANA - LUNARIA				
H	P	L	art.	
1,2	54	da / from 72	a / to	218,4
910 + SOAP72				

Per collezione / For collection				
PANTA REI				
H	P	L	art.	
1,2	54	da / from 72	a / to	216
PT2 + SOAP72				

Per collezione / For collection				
PLANETA				
H	P	L	art.	
1,2	54	da / from 72	a / to	216
LT2 + SOAP72				

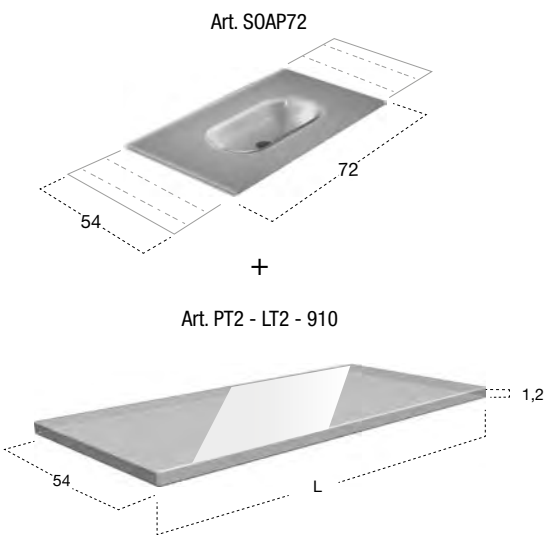

Per collezione / For collection				
ATELIER - BESPOKE - PIANA - LUNARIA				
H	P	L	art.	
1,2	54	da / from 90	a / to	218,4
910 + SOAP90				

Per collezione / For collection				
PANTA REI				
H	P	L	art.	
1,2	54	da / from 90	a / to	216
PT2 + SOAP90				

Per collezione / For collection				
PLANETA				
H	P	L	art.	
1,2	54	da / from 90	a / to	216
LT2 + SOAP90				

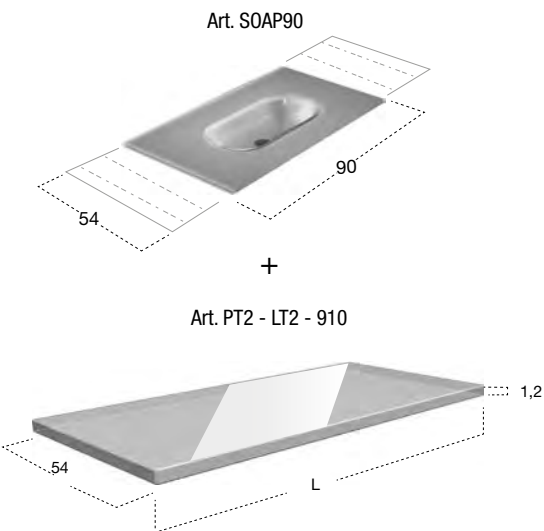

Top con lavabo integrato in VETRO spessore 12 mm, completo di piletta con scarico libero e raccordo per sifone. Verniciabile in tutti i colori del nostro campionario.

Top with integrated sink completely in glass 12 mm thick complete with drain pipe fitting and open plug. Can be lacquered in all colors of our collection.



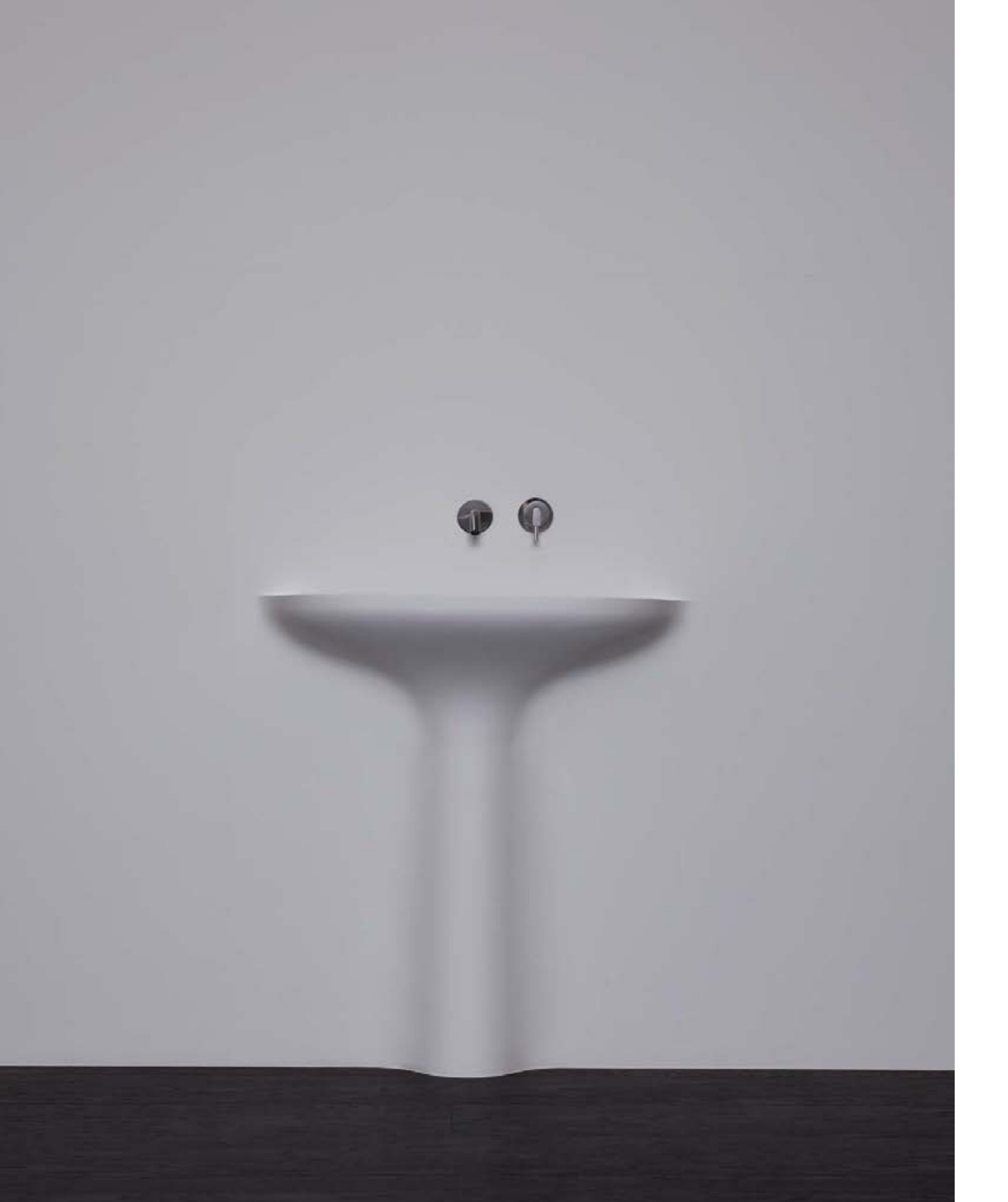

LAVABI / SINKS



**CALICE** design Domenico De Palo e Mario Ferrarini

Modello e design registrato, brevetto depositato  
*Registered model and design, patent filed*



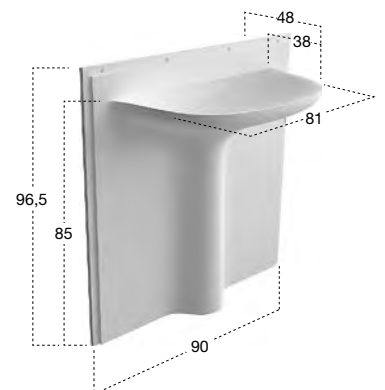

H	P	L	art.	art.
96,5	48	90	CALICE	CALICEL Con illuminazione a led / With led lighting

Lavabo da incasso a parete in Corian, con o senza illuminazione a led, completo di piletta ispezionabile, sifone e tubo flessibile.

*Encased Corian sink with or without led lighting, complete with inspectable drain, trap and flexible hose.*



**STRAPPO** design Domenico De Palo

Modello e design registrato, brevetto depositato  
*Registered model and design, patent filed*



COLORI / COLOURS

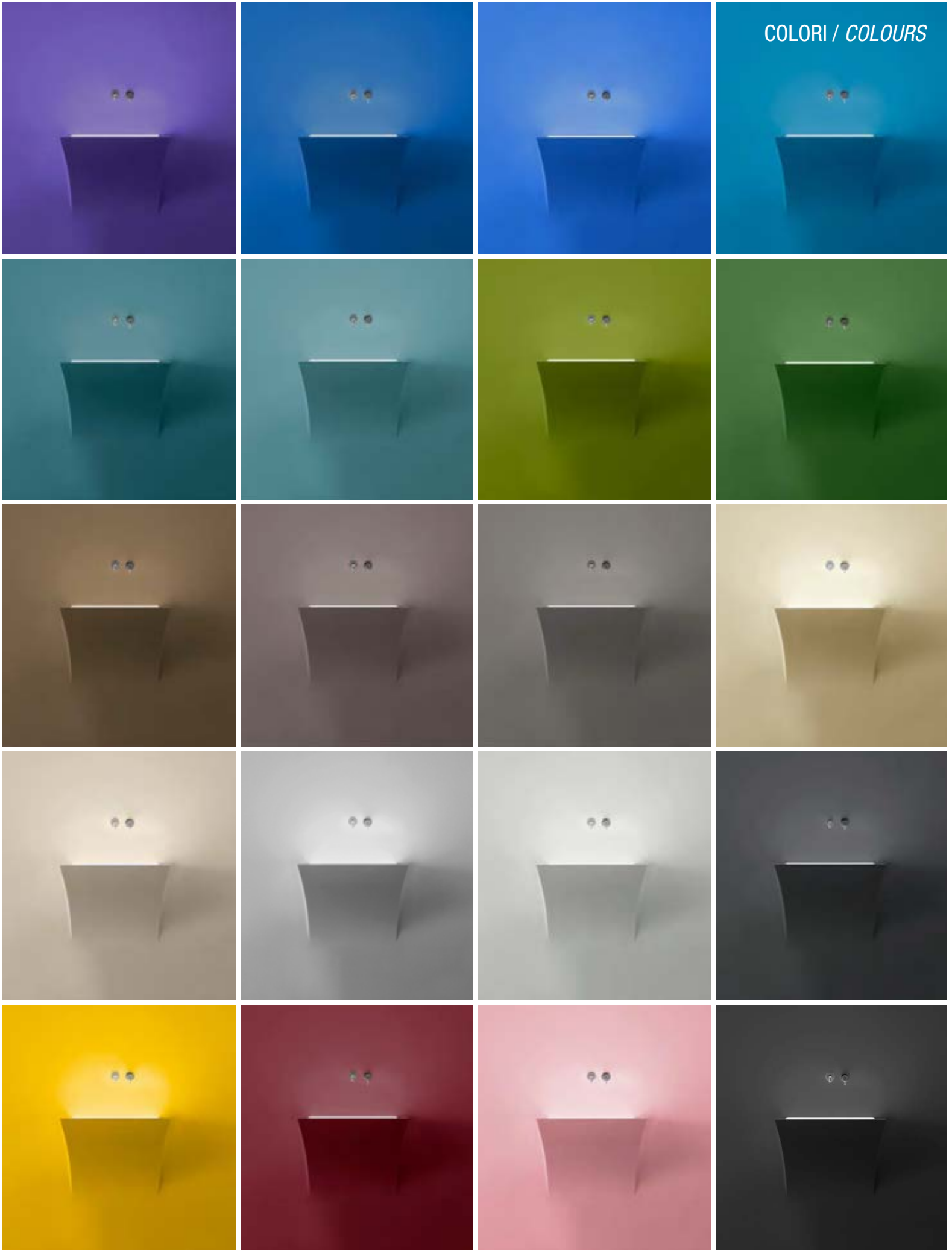

# STRAPPO

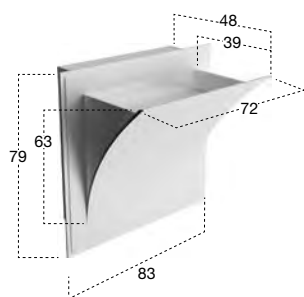

H	P	L	art.	art.
79	48	83	STRAPPO	STRAPPOL Con illuminazione a led / <i>With led lighting</i>

Lavabo da incasso a parete in Corian, con o senza illuminazione a led, completo di piletta ispezionabile, sifone e tubo flessibile.

*Encased Corian sink with or without led lighting, complete with inspectable drain, trap and flexible hose.*

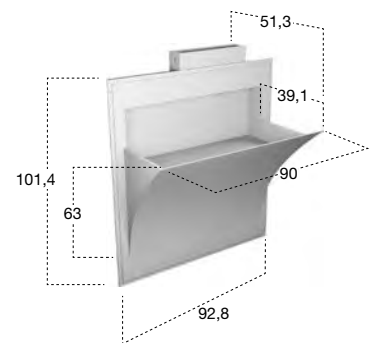

H	P	L	art.	art.
101,4	51,3	92,8	STRAPPOXL	STRAPPOXLL Con illuminazione a led / With led lighting

Lavabo da incasso a parete in Corian, con o senza illuminazione a led, completo di rubinetteria, piletta ispezionabile, sifone e tubo flessibile.

*Encased Corian sink with or without led lighting, complete with tap, inspectable drain, trap and flexible hose.*



**SILENZIO** design Domenico De Palo

Modello e design registrato, brevetto depositato  
*Registered model and design, patent filed*



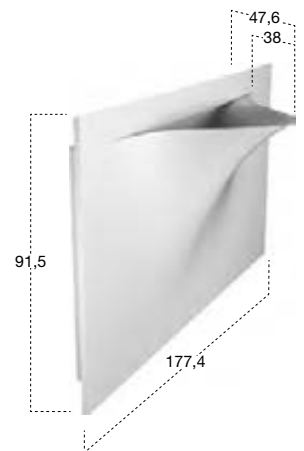

H	P	L	art.	art.
91,5	47,6	177,4	SILENZIO	SILENZIOL Con illuminazione a led / With led lighting

Lavabo da incasso a parete in Corian, con o senza illuminazione a led, completo di piletta ispezionabile, sifone e tubo flessibile.

*Encased Corian sink with or without led lighting, complete with inspectable drain, trap and flexible hose.*

**SOFFIO** design Domenico De Palo

Modello e design registrato, brevetto depositato  
*Registered model and design, patent filed*



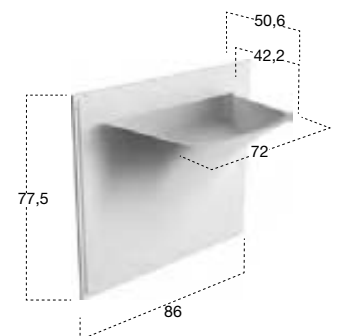

H	P	L	art.	art.
77,5	50,6	86	SOFFIO	SOFFIOL Con illuminazione a led / With led lighting

Lavabo da incasso a parete in Corian, con o senza illuminazione a led, completo di piletta ispezionabile, sifone e tubo flessibile.

*Encased Corian sink with or without led lighting, complete with inspectable drain, trap and flexible hose.*



**BATTIGIA** design Michel Boucquillon

Modello e design registrato, brevetto depositato

*Registered model and design, patent filed*

Dans toutes les choses de la nature il y a quelque chose de merveilleux

Aristotele

BATTIGIA, la merveille d'un lavabo inspiré par la nature.

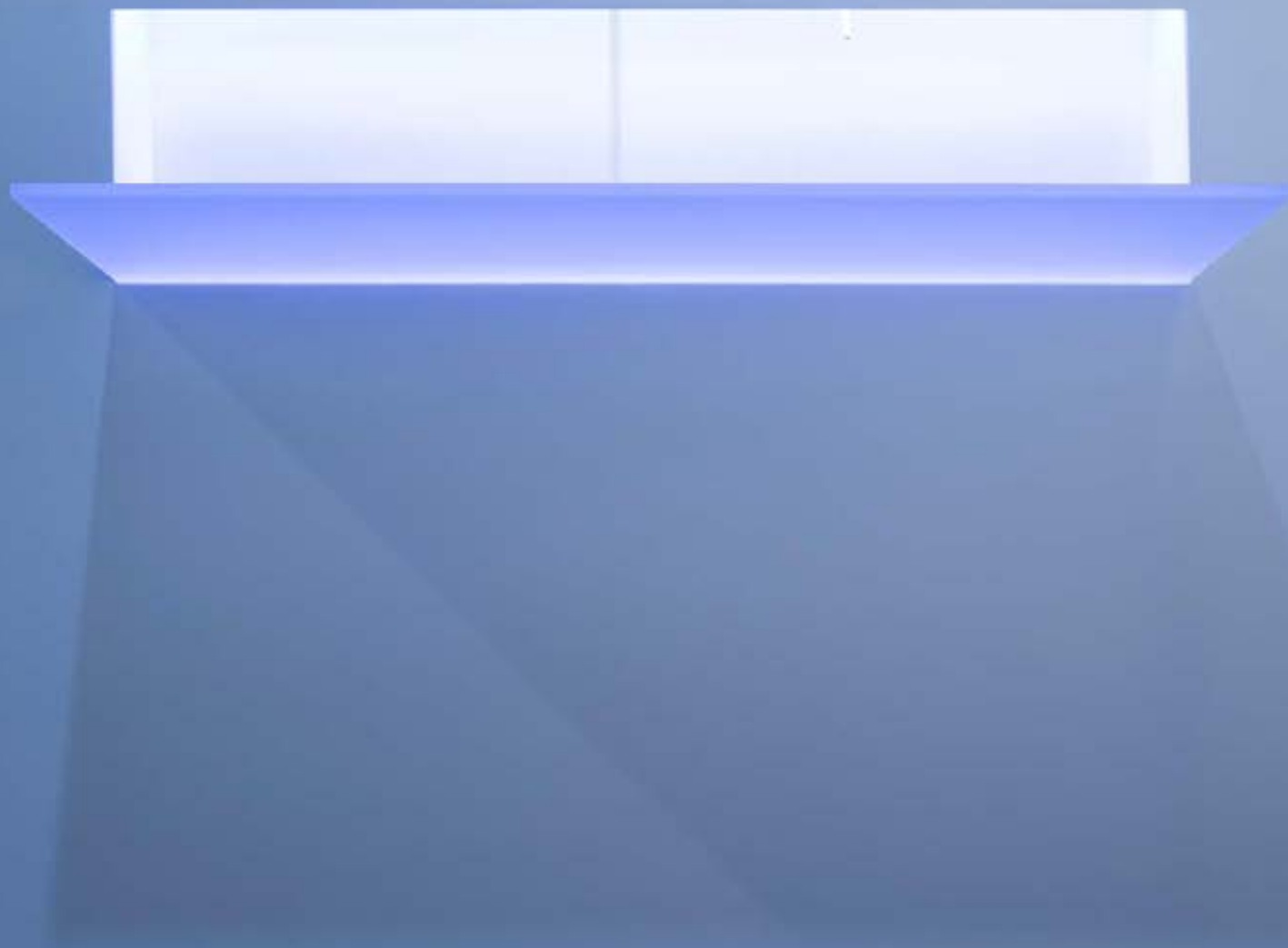



# BATTIGIA

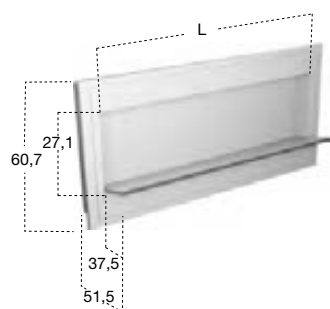

H	P	L	art.	art.
60,7	51,5	?	BATTIGIA	BATTIGIAL Con illuminazione a led / With led lighting

Lavabo da incasso a parete in Corian, con o senza illuminazione a led, completo di rubinetteria pileta ispezionabile, sifone e tubo flessibile, con lastra in vetro extrachiaro o vetro acidato. (L 90, 108, 126, 144, 180 cm)

*Encased Corian sink with or without led lighting, complete with tap, inspectable drain, siphon and flexible hose. Available with extra-clear or acid glass surface. (L 90, 108, 126, 144, 180 cm)*

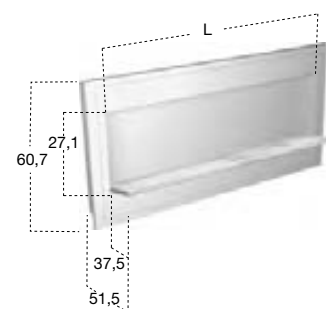

H	P	L	art.	art.
60,7	51,5	?	BATTIGIAM	BATTIGIAML Con illuminazione a led / With led lighting

Lavabo da incasso a parete in Corian, con o senza illuminazione a led, completo di rubinetteria piletta ispezionabile, sifone e tubo flessibile, con lastra in Marmo Carrara.  
(L 90, 108, 126, 144, 180 cm)

*Encased Corian sink with or without led lighting, complete with tap, inspectable drain, siphon and flexible hose, with Carrara marble surface.  
(L 90, 108, 126, 144, 180 cm)*



**CANALE** design Carlo Colombo

Modello e design registrato, brevetto depositato  
*Registered model and design, patent filed*





H	P	L	art.
5	33	20	PIANETTO

Pianetto optional in Flumood finitura Satin.

*Optional Flumood surface in satin finish.*

H	P	L	art.
12,5	47	?	CANALE

Lavabo rettangolare da parete in Flumood, completo di piletta con scarico libero e raccordo per sifone.  
(L da 90 cm a 216 cm)

*Rectangular wall mount Flumood sink, complete with drain pipe fitting and open plug.  
(L from 90 to 216 cm)*

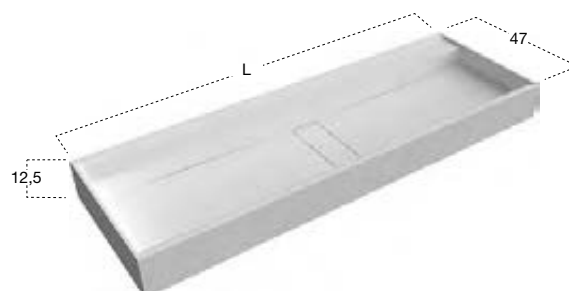
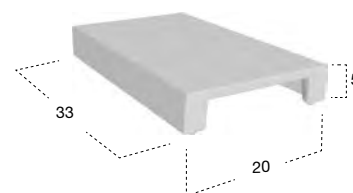



Verniciabile esternamente in tutti i colori del nostro campionario  
 Can be externally lacquered in all colors of our collection

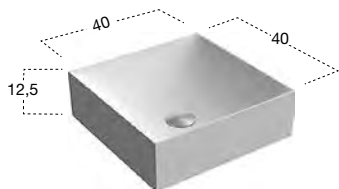
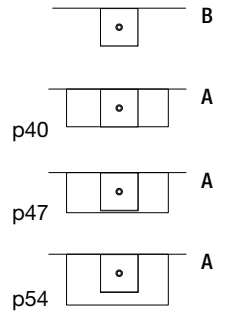

H	P	L	art.
12,5	40	40	STRATOS1

Lavabo quadrato sopra piano (A) o da parete (B) in Flumood, completo di piletta con scarico libero e raccordo per sifone.

Square top mount (A) or wall (B) mount Flumood sink, complete with drain pipe fitting and open plug.

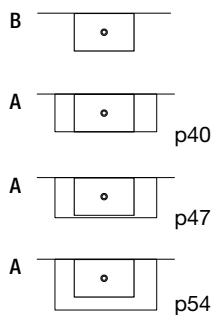

Verniciabile esternamente in tutti i colori del nostro campionario  
*Can be externally lacquered in all colors of our collection*

H	P	L	art.
12,5	40	63	STRATOS2

Lavabo rettangolare sopra piano (A) o da parete (B) in Flumood, completo di piletta con scarico libero e raccordo per sifone.

*Rectangular top mount (A) or wall mount (B) Flumood sink, complete with drain pipe fitting and open plug.*





# STRATOS



Verniciabile esternamente in tutti i colori del nostro campionario  
*Can be externally lacquered in all colors of our collection*

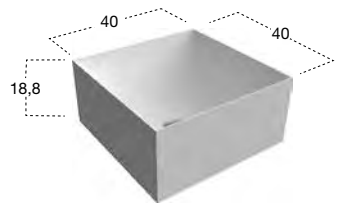
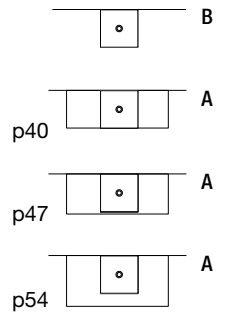

H	P	L	art.
18,8	40	40	STRATOS3

Lavabo quadrato sopraiano (A) o da parete (B) in Flumood, completo di piletta con scarico libero e raccordo per sifone.

*Square top mount (A) or wall mount (B) Flumood sink, complete with drain pipe fitting and open plug.*

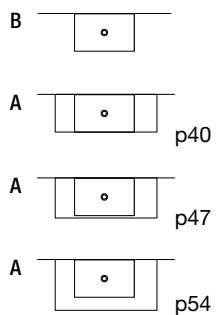

Verniciabile esternamente in tutti i colori del nostro campionario  
*Can be externally lacquered in all colors of our collection*

H	P	L	art.
18,8	40	63	STRATOS4

Lavabo rettangolare sopra piano (A) o da parete (B) in Flumood, completo di piletta con scarico libero e raccordo per sifone.

*Rectangular top mount (A) or wall mount (B) Flumood sink, complete with drain pipe fitting and open plug.*

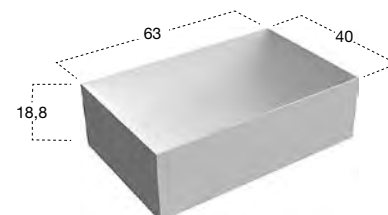



STRATOS1

L 40 P 40 H 12,5

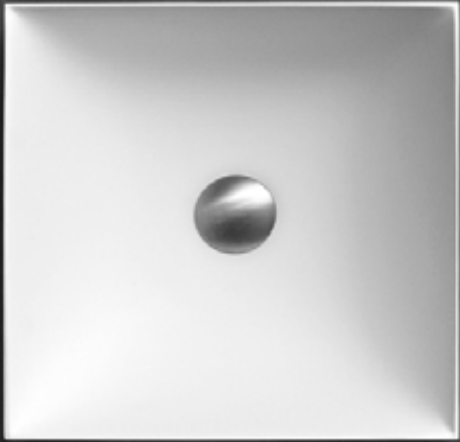

STRATOS2

L 63 P 40 H 12,5



STRATOS4

L 63 P 40 H 18,8



STRATOS3

L 40 P 40 H 18,8



# SIMPLO design Mario Ferrarini

Modello e design registrato, brevetto depositato  
Registered model and design, patent filed



Verniciabile esternamente in tutti i colori del nostro campionario  
Can be externally lacquered in all colors of our collection

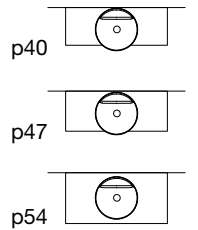

H	Ø	art.
11	45	SIMPLOTONDO

Lavabo tondo sopraiano in Flumood completo di piletta con scarico libero e raccordo per sifone.

Round top mount Flumood sink complete with drain pipe fitting and open plug.

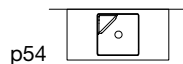
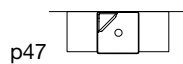
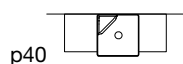

Verniciabile esternamente in tutti i colori del nostro campionario  
*Can be externally lacquered in all colors of our collection*

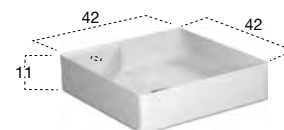

H	P	L	art.
11	42	42	SIMPL042

Lavabo quadrato sopra piano dx o sx in Flumood completo di piletta con scarico libero e raccordo per sifone.

*Right or left hand square top mount Flumood sink complete with drain pipe fitting and open plug.*

# SIMPLO



Verniciabile esternamente in tutti i colori del nostro campionario  
*Can be externally lacquered in all colors of our collection*

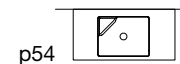
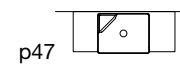
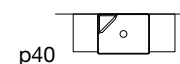

H	P	L	art.
11	42	54	SIMPL054

Lavabo rettangolare sopra piano in Flumood completo di piletta con scarico libero e raccordo per sifone.

*Rectangular top mount Flumood sink complete with drain pipe fitting and open plug.*

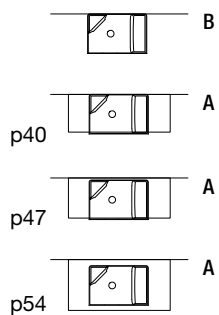

Verniciabile esternamente in tutti i colori del nostro campionario  
 Can be externally lacquered in all colors of our collection



H	P	L	art.
11	42	63	SIMPL063

Lavabo rettangolare sopra piano (A) o da parete (B) in Flumood completo di piletta con scarico libero e raccordo per sifone.

Rectangular top mount (A) or wall mount (B) Flumood sink complete with drain pipe fitting and open plug.



# SIMPLO



Verniciabile esternamente in tutti i colori del nostro campionario  
 Can be externally lacquered in all colors of our collection

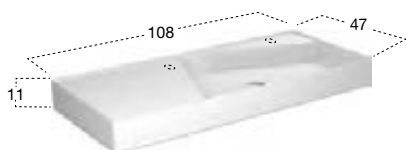
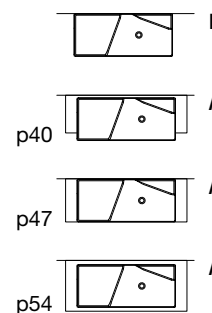

H	P	L	art.
11	47	108	SIMPL0108

Lavabo rettangolare sopra piano (A) o da parete (B) in Flumood completo di piletta con scarico libero e raccordo per sifone.

Rectangular top mount (A) or wall mount (B) Flumood sink complete with drain pipe fitting and open plug.

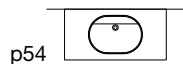
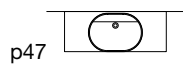
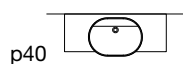

Verniciabile esternamente in tutti i colori del nostro campionario  
*Can be externally lacquered in all colors of our collection*

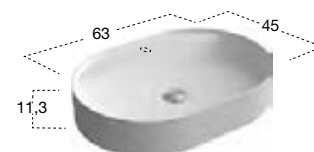

H	P	L	art.
11,3	45	63	SIMPLOVALE

Lavabo ovale sopra piano in Flumood, completo di piletta con scarico libero e raccordo per sifone.

*Oval top mount Flumood sink, complete with drain pipe fitting and open plug.*

# SIMPLO



Verniciabile esternamente in tutti i colori del nostro campionario  
*Can be externally lacquered in all colors of our collection*

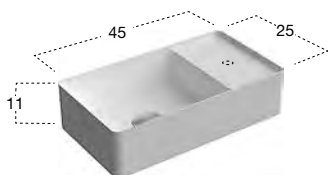
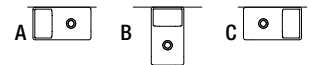

H	P	L	art.
11	25	45	SIMPLOMANI

Lavabo rettangolare sopra piano o da parete in Flumood, completo di piletta con scarico libero e raccordo per sifone.

*Rectangular top mount or wall mount Flumood sink, complete with drain pipe fitting and open plug.*

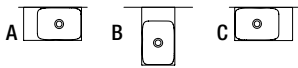

	H	P	L	art.
	25	25	45	CALCO

Lavabo rettangolare da parete in Flumood finitura texture completo di piletta con scarico libero e raccordo per sifone.

*Rectangular wall mount Flumood texture sink, complete with drain pipe fitting and open plug.*

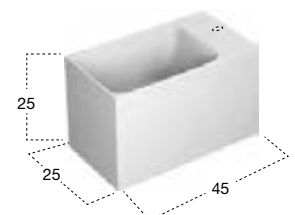



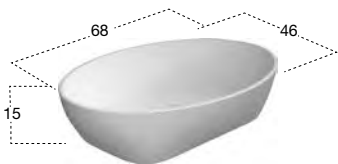
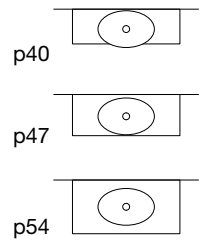

H	P	L	art.
15	46	68	SOLIDEA

Lavabo ovale sopraiano in Cristalplant completo di piletta con scarico libero e raccordo per sifone.

*Oval top mount Cristalplant sink complete with drain pipe fitting and open plug.*

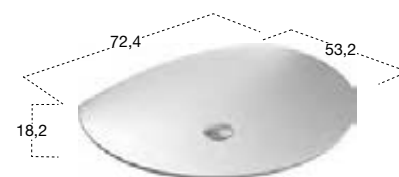

H	P	L	art.
18,2	53,2	72,4	VENERE

Lavabo ovale da parete in Flumood, completo di piletta con scarico libero e raccordo per sifone.

*Oval wall mount Flumood sink, complete with drain pipe fitting and open plug.*



Verniciabile esternamente in tutti i colori del nostro campionario  
 Can be externally lacquered in all colors of our collection

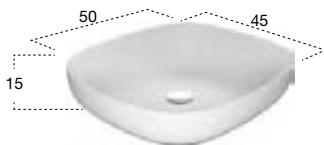
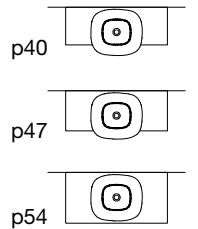

H	P	L	art.
15	45	50	AG03

Lavabo ovale sopra piano in Flumood completo di piletta con scarico libero e raccordo per sifone.

*Oval top mount Flumood sink complete with drain pipe fitting and open plug.*

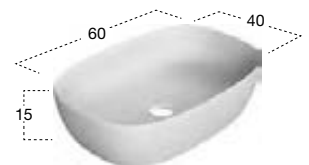
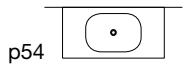
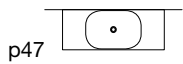
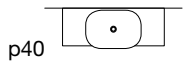

H	P	L	art.
15	40	60	SENSO

Lavabo rettangolare sopra piano in Flumood completo di piletta con scarico libero e raccordo per sifone.

Rectangular top mount Flumood sink complete with drain pipe fitting and open plug.





Verniciabile esternamente in tutti i colori del nostro campionario  
*Can be externally lacquered in all colors of our collection*

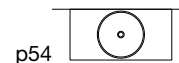
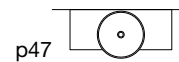
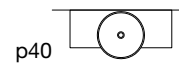

H	Ø	art.
12	50	VERSO

Lavabo tondo sopra piano in Flumood completo di piletta con scarico libero e raccordo per sifone.

*Round top mount Flumood sink complete with drain pipe fitting and open plug.*



CATINO43 Ø 43 cm

CATINO43

CATINO

Verniciabile esternamente in tutti i colori del nostro campionario  
*Can be externally lacquered in all colors of our collection*

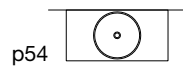
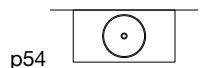
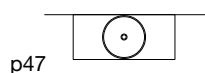

H	Ø	art.
15	43	CATINO43
15	50	CATINO

Lavabo tondo sopra piano in Flumood completo di piletta con scarico libero e raccordo per sifone.

*Round top mount Flumood sink complete with drain pipe fitting and open plug.*

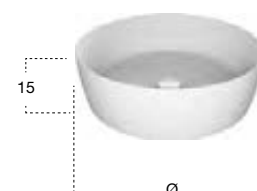

# SERVO

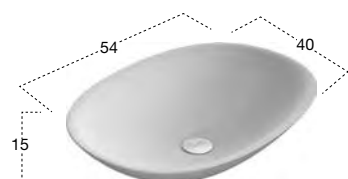
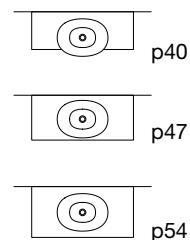

H	P	L	art.
15	40	54	SERVOM00D54

Lavabo ovale sopra piano in Flumood, completo di piletta con scarico libero e raccordo per sifone.

*Oval top mount Flumood sink, complete with drain pipe fitting and open plug.*

H	P	L	art.
15	40	54	SERV054

Lavabo ovale sopra piano in Ceramilux, completo di piletta con scarico libero e raccordo per sifone.

*Oval top mount Ceramilux sink, complete with drain pipe fitting and open plug.*

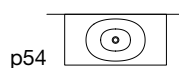
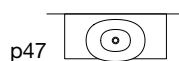
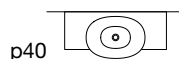

H	P	L	art.
15	45	63	SERV000D63

Lavabo ovale sopraiano in Flumood completo di piletta con scarico libero e raccordo per sifone.

*Oval top mount Flumood sink complete with drain pipe fitting and open plug.*

H	P	L	art.
15	45	63	SERV063

Lavabo ovale sopraiano in Ceramilux completo di piletta con scarico libero e raccordo per sifone.

*Oval top mount Ceramilux sink complete with drain pipe fitting and open plug.*

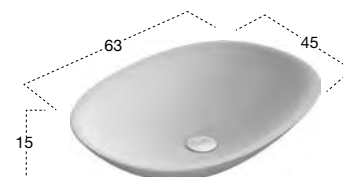



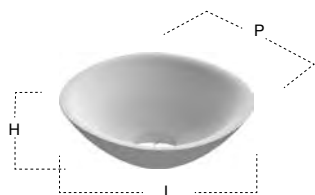
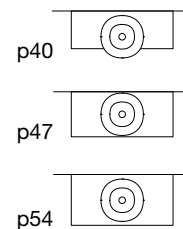

H	P	L	art.
15	45	45	SERVOM00D45

Lavabo tondo sopra piano in Flumood, completo di piletta con scarico libero e raccordo per sifone.

*Round top mount Flumood sink, complete with drain pipe fitting and open plug.*

H	P	L	art.
12,5	35	35	SERV035
15	45	45	SERV045

Lavabo tondo sopra piano in Ceramilux, completo di piletta con scarico libero e raccordo per sifone.

*Round top mount Ceramilux sink, complete with drain pipe fitting and open plug.*

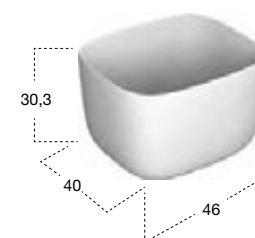
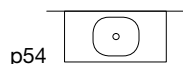
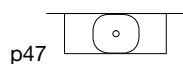
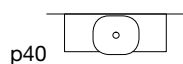

H	P	L	art.
30,3	40	46	POGGIO

Lavabo rettangolare sopraiano in Flumood completo di piletta con scarico libero e raccordo per sifone.

*Rectangular top mount Flumood sink complete with drain pipe fitting and open plug.*



Verniciabile esternamente in tutti i colori del nostro campionario  
*Can be externally lacquered in all colors of our collection*

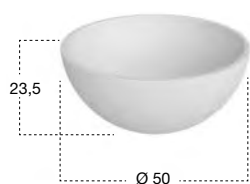
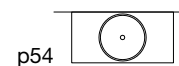
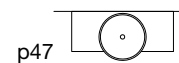
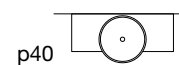

H	Ø	art.
23,5	50	URNAMOOD

Lavabo tondo sopra piano in Flumood completo di piletta con scarico libero e raccordo per sifone.

*Round top mount Flumood sink complete with drain pipe fitting and open plug.*

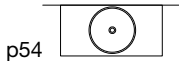
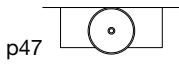
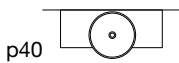

\* Verniciabile esternamente in tutti i colori del nostro campionario  
*Can be externally lacquered in all colors of our collection*

H	Ø	art.
20	50	TONDOMOOD *

Lavabo tondo sopra piano in Flumood completo di piletta con scarico libero e raccordo per sifone.

*Round top mount Flumood sink complete with drain pipe fitting and open plug.*

H	Ø	art.
20	50	SERVOTONDO

Lavabo tondo sopra piano in Ceramilux, completo di piletta con scarico libero e raccordo per sifone.

*Round top mount Ceramilux sink complete with drain pipe fitting and open plug.*

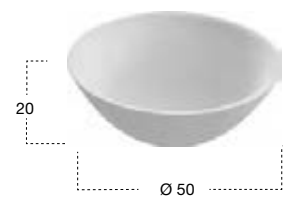



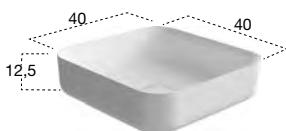
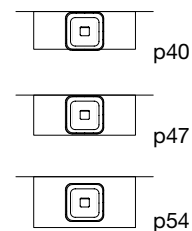

H	P	L	art.
12,5	40	40	BOLOMOOD40

Lavabo quadrato sopra piano in Flumood completo di piletta con scarico libero e raccordo per sifone.

*Square top mount Flumood sink complete with drain pipe fitting and open plug.*

H	P	L	art.
12,5	40	40	BOLO40

Lavabo quadrato sopra piano in Ceramilux completo di piletta con scarico libero e raccordo per sifone.

*Square top mount Ceramilux sink complete with drain pipe fitting and open plug.*

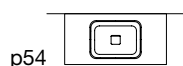
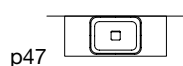
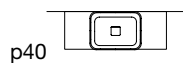

H	P	L	art.
12,5	40	54	BOLOMOOD54

Lavabo rettangolare sopraiano in Flumood completo di piletta con scarico libero e raccordo per sifone.

*Rectangular top mount Flumood sink complete with drain pipe fitting and open plug.*

H	P	L	art.
12,5	40	54	BOLO54

Lavabo rettangolare sopraiano in Ceramilux completo di piletta con scarico libero e raccordo per sifone.

*Rectangular top mount Ceramilux sink complete with drain pipe fitting and open plug.*

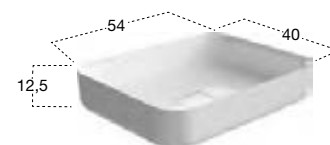

# BOLO

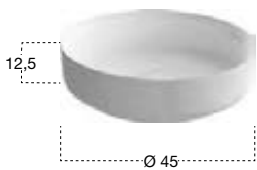
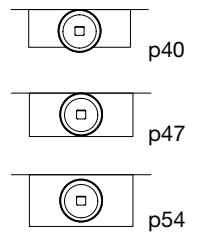

H	Ø	art.
12,5	45	BOLOM00D45

Lavabo tondo sopraiano in Flumood completo di piletta con scarico libero e raccordo per sifone.

*Round top mount Flumood sink complete with drain pipe fitting and open plug.*

H	Ø	art.
12,5	45	BOLO45

Lavabo tondo sopraiano in Ceramilux completo di piletta con scarico libero e raccordo per sifone.

*Round top mount Ceramilux sink complete with drain pipe fitting and open plug.*



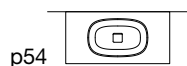
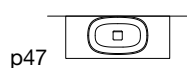
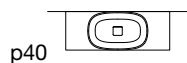

H	P	L	art.
12,5	40	63	BOLOM00D63

Lavabo ovale sopraiano in Flumood completo di piletta con scarico libero e raccordo per sifone.

*Oval top mount Flumood sink complete with drain pipe fitting and open plug.*

H	P	L	art.
12,5	40	63	BOL063

Lavabo ovale sopraiano in Ceramilux completo di piletta con scarico libero e raccordo per sifone.

*Oval top mount Ceramilux sink complete with drain pipe fitting and open plug.*

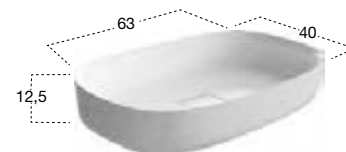



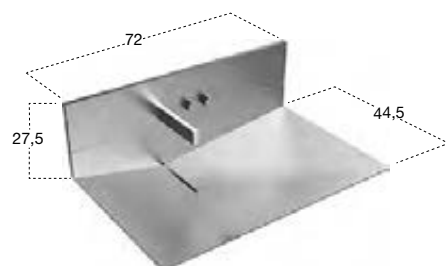

H	P	L	art.
27,5	44,5	72	LAVANDINO

Lavabo rettangolare da parete in acciaio inox AISI 316/L completo di rubinetteria, scarico libero e raccordo per sifone.

*Rectangular wall mount stainless steel AISI 316/L sink, complete with tap, drain pipe fitting and open plug.*

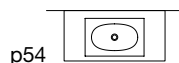
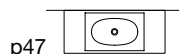

H	P	L	art.
14	40,4	63	FOGLIOM00D63

Lavabo rettangolare sopra piano ad incasso in Flumood, completo di piletta con scarico libero e raccordo per sifone.

*Rectangular encased Flumood sink, complete with drain pipe fitting and open plug.*

H	P	L	art.
14	40,4	63	FOGLIO63

Lavabo rettangolare sopra piano ad incasso in Ceramilux, completo di piletta con scarico libero e raccordo per sifone.

*Rectangular encased Ceramilux sink, complete with drain pipe fitting and open plug.*

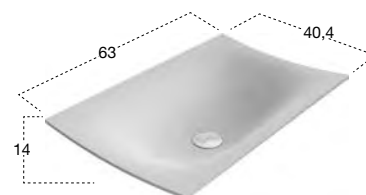



RETTM00D50  
SERVORETTO50

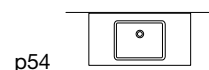
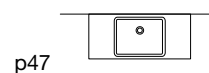
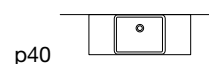

RETTM00D63  
SERVORETTO63

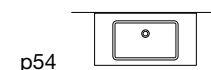
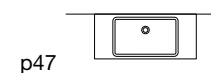
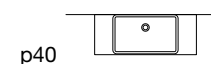

H	P	L	art.
13	38	50	RETTM00D50
	38	63	RETTM00D63

Lavabo rettangolare sopra piano in Flumood completo di piletta con scarico libero e raccordo per sifone.

*Rectangular top mount Flumood sink complete with drain pipe fitting and open plug.*

H	P	L	art.
13	38	50	SERVORETTO50
	38	63	SERVORETTO63

Lavabo rettangolare sopra piano in Ceramilux completo di piletta con scarico libero e raccordo per sifone.

*Rectangular top mount Ceramilux sink complete with drain pipe fitting and open plug.*



RETTM00D50  
SERVORETTO50

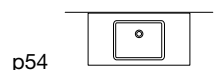
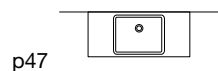

RETTM00D63  
SERVORETTO63

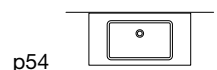
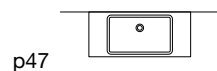

H	P	L	art.
13	38	50	RETTM00D50
	38	63	RETTM00D63

Lavabo rettangolare sottopiano in Flumood completo di piletta con scarico libero e raccordo per sifone.

*Rectangular undermount Flumood sink complete with drain pipe fitting and open plug.*

H	P	L	art.
13	38	50	SERVORETTO50
	38	63	SERVORETTO63

Lavabo rettangolare sottopiano in Ceramilux completo di piletta con scarico libero e raccordo per sifone.

*Rectangular undermount Ceramilux sink complete with drain pipe fitting and open plug.*





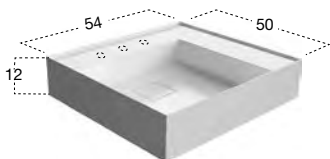
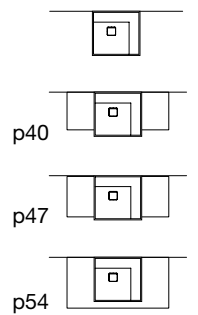

H	P	L	art.
12	50	54	GRAFFIO54

Lavabo rettangolare sopraiano o da parete in Ceramilux con ripiano, completo di piletta con scarico libero e raccordo per sifone.

*Rectangular top mount or wall mount Ceramilux sink with shelf, complete with drain pipe fitting and open plug.*

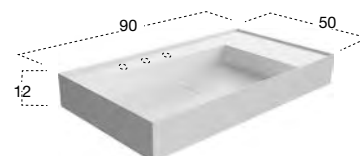
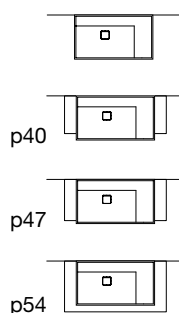

H	P	L	art.
12	50	90	GRAFFIO90

Lavabo rettangolare sopra piano o da parete in Ceramilux con ripiano, completo di piletta con scarico libero e raccordo per sifone.

*Rectangular top mount or wall mount Ceramilux sink with shelf, complete with drain pipe fitting and open plug.*

# GRAFFIO

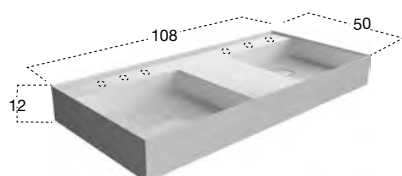
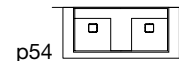
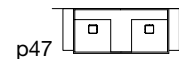
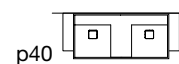
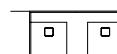

H	P	L	art.
12	50	108	GRAFFIO108

Lavabo rettangolare sopra piano o da parete in Ceramilux con ripiano, completo di piletta con scarico libero e raccordo per sifone.

*Rectangular top mount or wall mount Ceramilux sink with shelf, complete with drain pipe fitting and open plug.*



GRAFFIO





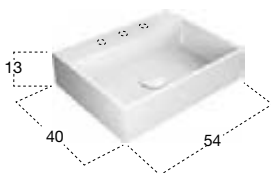
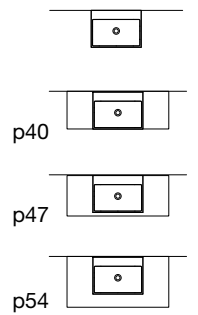

H	P	L	art.
13	40	54	GEST054

Lavabo rettangolare sopra piano o da parete in Ceramilux lucido o opaco, completo di piletta con scarico libero e raccordo per sifone.

*Rectangular top mount or wall mount glossy or matt Ceramilux sink, complete with drain pipe fitting and open plug.*



GEST063

GEST090

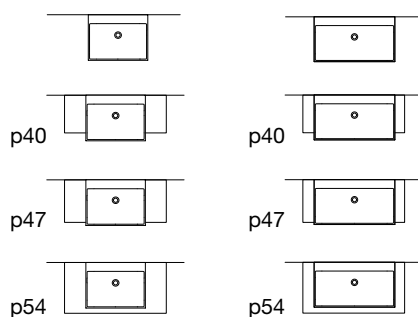

H	P	L	art.
13	50	63	GEST063
	50	90	GEST090

Lavabo rettangolare sopra piano o da parete in Ceramilux lucido o opaco, completo di piletta con scarico libero e raccordo per sifone.

*Rectangular top mount or wall mount glossy or matt Ceramilux sink, complete with drain pipe fitting and open plug.*

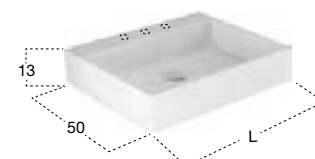

# GESTO

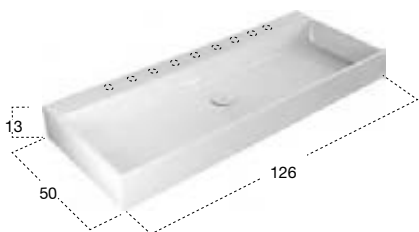
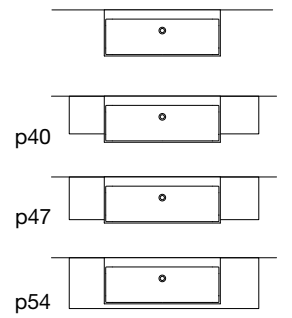

H	P	L	art.
13	50	126	GEST0126

Lavabo rettangolare sopra piano o da parete in Ceramilux lucido o opaco, completo di piletta con scarico libero e raccordo per sifone.

*Rectangular top mount or wall mount glossy or matt Ceramilux sink, complete with drain pipe fitting and open plug.*







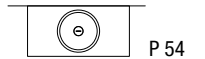

H	Ø	art.	
16	45	INTROVERSO45	Marmo Carrara

Lavabo tondo sopra piano in pietra, completo di piletta con scarico libero e raccordo per sifone.

*Round top mount stone sink complete with drain pipe fitting and open plug.*

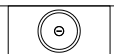

P 54



	H	Ø	art.
Marmo Carrara	11	45	PIXEL45

Lavabo tondo sopra piano in pietra, completo di piletta con scarico libero e raccordo per sifone.

Round top mount stone sink complete with drain pipe fitting and open plug.





Verniciabile esternamente in tutti i colori del nostro campionario  
*Can be externally lacquered in all colors of our collection*

H	Ø	art.
85	50	AGO85

Lavabo da terra in Flumood con scarico a pavimento, completo di piletta con scarico libero, sifone e tubo flessibile.

*Freestanding Flumood sink with floor drainage complete with open plug, siphon and flexible hose.*





# SIMPLO design Mario Ferrarini

Modello e design registrato, brevetto depositato  
*Registered model and design, patent filed*



Verniciabile esternamente in tutti i colori del nostro campionario  
*Can be externally lacquered in all colors of our collection*

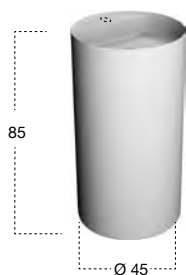

H	Ø	art.
85	45	SIMPLO85

Lavabo da terra in Flumood con scarico a pavimento, completo di piletta con scarico libero sifone e tubo flessibile.

*Freestanding Flumood sink with floor drainage complete with open plug siphon and flexible hose.*

COLORI / COLOURS





Verniciabile esternamente in tutti i colori del nostro campionario  
*Can be externally lacquered in all colors of our collection*

FOLDVE

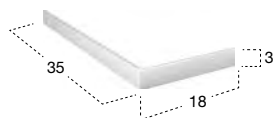

FUSTO

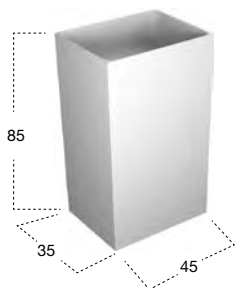

H	P	L	art.
3	35	18	FOLDVE

Porta salviette in acciaio inox AISI 304 verniciato gofrato come da nostra cartella colori laccati.

*Towel holder in stainless steel AISI 304 embossed lacquer finish as per our colour chart.*

H	P	L	art.
85	35	45	FUSTO

Lavabo da terra in Flumood con scarico a pavimento, completo di piletta con scarico libero sifone e tubo flessibile.

*Freestanding Flumood sink with floor drainage complete with open plug siphon and flexible hose.*

COLORI / COLOURS







Verniciabile esternamente in tutti i colori del nostro campionario  
*Can be externally lacquered in all colors of our collection*

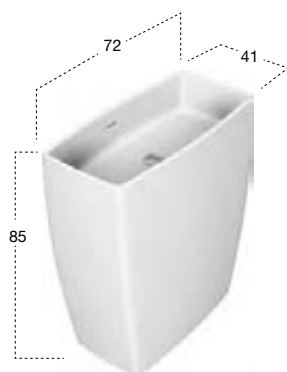

H	P	L	art.
85	41	72	TENDER

Lavabo da terra in Cristalplant con scarico a pavimento, completo di piletta con scarico a pressione klik-clak, sifone e tubo flessibile.

*Freestanding Cristalplant sink with floor drainage complete with pressure plug, siphon and flexible hose.*



Verniciabile esternamente in tutti i colori del nostro campionario  
 Can be externally lacquered in all colors of our collection

H	Ø	art.
90	50,4	TUBAMOOD

Lavabo da terra in Flumood con scarico a pavimento, completo di piletta con scarico libero, sifone e tubo flessibile.

*Freestanding Flumood sink with floor drainage complete with open plug, siphon and flexible tube.*

H	Ø	art.
90	50,4	TUBA3

Lavabo da terra in Cristalplant con scarico a pavimento, completo di piletta con scarico libero, sifone e tubo flessibile.

*Freestanding Cristalplant sink with floor drainage complete with open plug, siphon and flexible tube.*

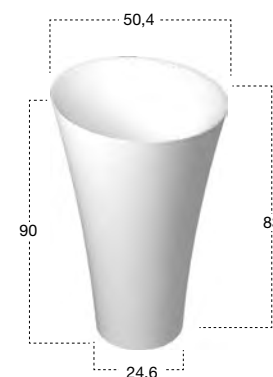



H	Ø	art.
85	65	BARREL3

Lavabo da terra in Cristalplant con scarico a pavimento, completo di piletta con scarico a pressione klik-clak, sifone e tubo flessibile.

*Freestanding Cristalplant sink with floor drainage complete with pressure plug, siphon and flexible hose.*

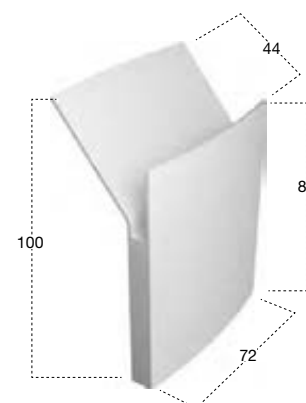

H	P	L	art.
100	44	72	MR.SPLASH

Lavabo da terra in Cristalplant con scarico a pavimento, completo di piletta con scarico libero, sifone e tubo flessibile.

*Freestanding Cristalplant sink with floor drainage complete with open plug, siphon and flexible hose.*



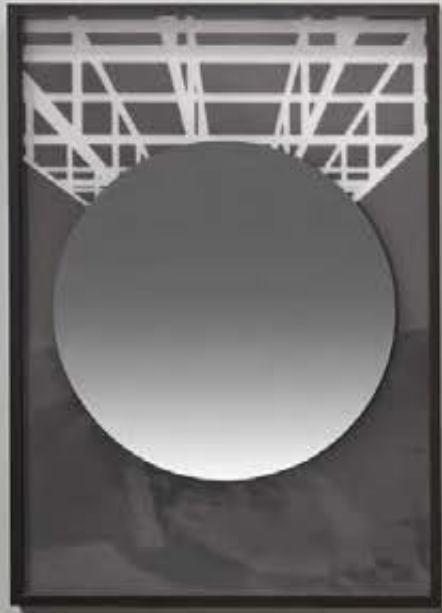



	H	Ø	art.
Marmo Carrara	85	47,5	INTRECCIO
Marmo Carrara LED	85	47,5	INTRECCIOL

Lavabo da terra in pietra con scarico a pavimento, con o senza illuminazione a led, completo di piletta con scarico libero, sifone e tubo flessibile.  
Peso lavabo: 55 kg ca.

*Freestanding stone sink with floor drainage with or without led lighting, complete with open plug, siphon and flexible hose.  
Sink weight: 55 kg approx*

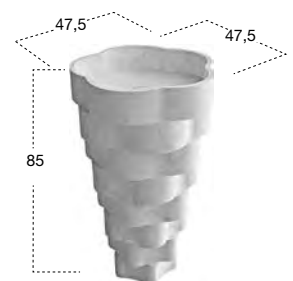

**INTROVERSO** design Paolo Ulian

Modello e design registrato, brevetto depositato  
*Registered model and design, patent filed*





	H	Ø	art.
Marmo Carrara	85	45	INTROVERSO1

Lavabo da terra in pietra con scarico a pavimento, completo di piletta con scarico libero, sifone e tubo flessibile. Peso lavabo: 223 kg ca.

*Freestanding stone sink with floor drainage complete with open plug, siphon and flexible hose.  
Sink weight: 223 kg approx*

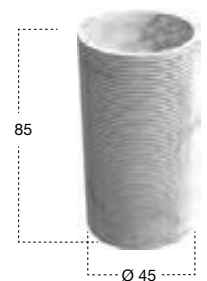



# INTROVERSO



H	Ø	art.	
85	45	INTROVERSO3	Marmo Carrara

Lavabo da terra in pietra con scarico a pavimento, completo di piletta con scarico libero, sifone e tubo flessibile.  
Peso lavabo: 223 kg ca.

*Freestanding stone sink with floor drainage complete with open plug, siphon and flexible hose.  
Sink weight: 223 kg approx*



	H	Ø	art.
Marmo Carrara	85	45	INTROVERSO2

Lavabo da terra in pietra con scarico a pavimento, completo di piletta con scarico libero, sifone e tubo flessibile.

Peso lavabo: 223 kg ca.

*Freestanding stone sink with floor drainage complete with open plug, siphon and flexible hose.  
Sink weight: 223 kg approx.*

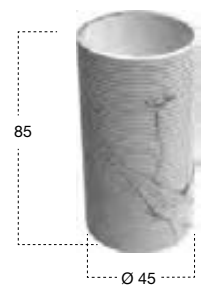

**CONTROVERSO** design Paolo Ulian

Modello e design registrato, brevetto depositato  
*Registered model and design, patent filed*



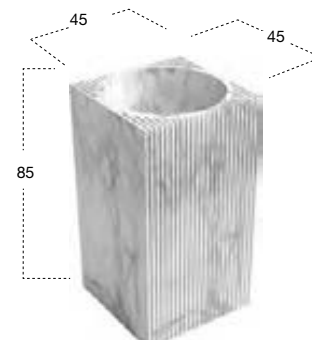

	H	P	L	art.
Marmo Carrara	85	45	45	CONTROVERSO

Lavabo da terra in pietra con scarico a pavimento, completo di piletta con scarico libero, sifone e tubo flessibile.

Peso lavabo: 361 kg ca.

*Freestanding stone sink with floor drainage complete with open plug, siphon and flexible hose.*

*Sink weight: 361 kg approx.*



**PIXEL** design Paolo Ulian

Modello e design registrato, brevetto depositato  
*Registered model and design, patent filed*

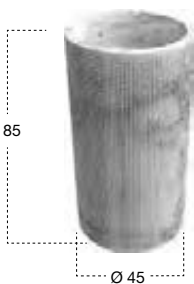

H	Ø	art.	
85	45	PIXEL	Marmo Carrara

Lavabo da terra in pietra con scarico a pavimento, completo di piletta con scarico libero, sifone e tubo flessibile.  
Peso lavabo: 177 kg ca.

*Freestanding stone sink with floor drainage complete with open plug, siphon and flexible hose.  
Sink weight: 177 kg approx.*

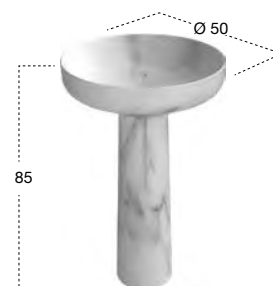

	H	Ø	art.
Marmo Carrara / Nero Marquina	85	50	AG0185

Lavabo da terra in pietra con scarico a pavimento, completo di piletta con scarico libero, sifone e tubo flessibile.

Peso lavabo: 57 kg ca.

*Freestanding stone sink with floor drainage complete with open plug, siphon and flexible hose.  
Sink weight: 57 kg approx.*

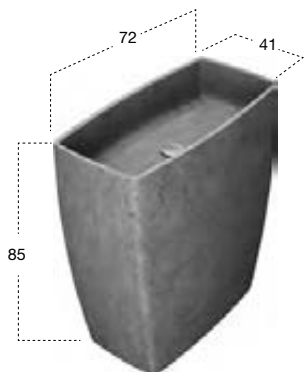

H	P	L	art.	
85	41	72	TENDERSG	Pietra Stone Grey

Lavabo da terra in pietra con scarico a pavimento, completo di piletta con scarico libero, sifone e tubo flessibile. Peso lavabo: 300 kg ca.

*Freestanding stone sink with floor drainage complete with open plug, siphon and flexible hose. Sink weight: 300 kg approx.*

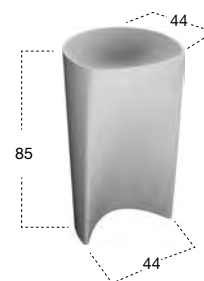

	H	P	L	art.
Pietra Amazzone	85	44	44	RILIEVO

Lavabo da terra in pietra con scarico a pavimento, completo di piletta con scarico libero, sifone e tubo flessibile. Peso lavabo: 170 kg ca.

*Freestanding stone sink with floor drainage complete with open plug, siphon and flexible hose. Sink weight: 170 kg approx.*



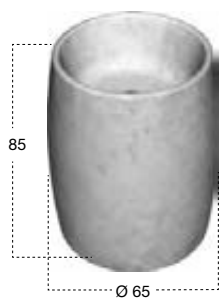

H	Ø	art.	
85	65	BARREL	Pietra Sinai / Nero Marquina

Lavabo da terra in pietra con scarico a pavimento, completo di piletta con scarico libero, sifone e tubo flessibile.  
Peso lavabo: 320 kg ca.

*Freestanding stone sink with floor drainage complete with open plug, siphon and flexible hose.  
Sink weight: 320 kg approx.*

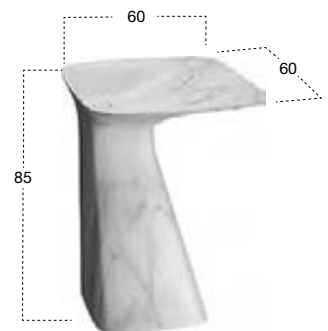

	H	P	L	art.
Marmo di Carrara	85	60	60	DIERESI

Lavabo da terra in pietra con scarico a pavimento, completo di piletta con scarico libero, sifone e tubo flessibile.  
 Peso lavabo: 190 kg ca.

*Freestanding stone sink with floor drainage complete with open plug, siphon and flexible hose.  
 Sink weight: 190 kg approx.*



VASCHE / TUBS







Verniciabile esternamente in tutti i colori del nostro campionario  
Can be externally lacquered in all colors of our collection

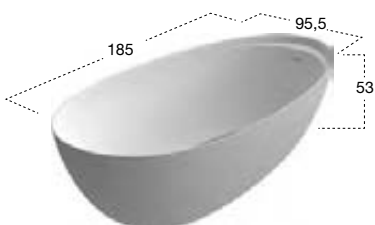
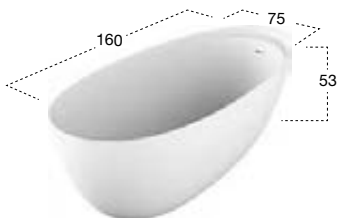

H	P	L	art.
53	75	160	ECLIPSES

Vasca da bagno ovale in Cristalplant, completa di piletta con sistema di scarico a pressione clik clak, sifone e tubo flessibile.  
Peso vasca: 82 kg.  
Capacità: 240 L.

*Oval Cristalplant bathtub complete with drain and pressure plug, siphon and flexible hose.  
Weight: 82 kg.  
Capacity: 240 L.*

H	P	L	art.
53	95,5	185	ECLIPSE

Vasca da bagno ovale in Cristalplant, completa di piletta con sistema di scarico a pressione clik clak, sifone e tubo flessibile.  
Peso vasca: 141 kg.  
Capacità: 350 L.

*Oval Cristalplant bathtub complete with drain and pressure plug, siphon and flexible hose.  
Weight: 141 kg.  
Capacity: 350 L.*

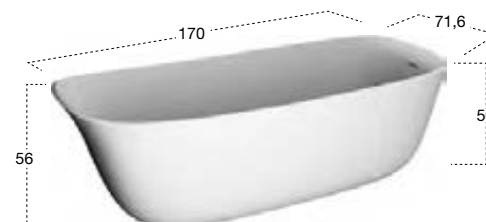

H	P	L	art.
56	71,6	170	DAFNE

Vasca da bagno ovale in Cristalplant, completa di piletta con sistema di scarico a pressione clik clak, sifone e tubo flessibile.

Peso vasca: 110 kg.

Capacità: 275 L.

*Oval Cristalplant bathtub complete with drain and pressure plug, siphon and flexible hose.*

*Weight: 110 kg.*

*Capacity: 275 L.*



Verniciabile esternamente in tutti i colori del nostro campionario  
*Can be externally lacquered in all colors of our collection*



H	P	L	art.
50	90	185	BAiA

Vasca da bagno ovale in Cristalplant, completa di piletta con sistema di scarico a pressione clik-clak, sifone e tubo flessibile.  
Peso vasca: 90 kg.  
Capacità: 400 L.

*Oval Cristalplant bathtub complete with drain pipe fitting and pressure plug, siphon and flexible hose.  
Weight: 90 kg.  
Capacity: 400 L.*



Verniciabile esternamente in tutti i colori del nostro campionario  
*Can be externally lacquered in all colors of our collection*

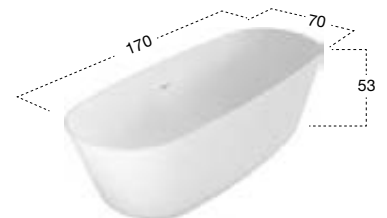

H	P	L	art.
53	70	170	BAIAS

Vasca da bagno ovale in Cristalplant, completa di piletta con sistema di scarico a pressione clik-clak, sifone e tubo flessibile.

Peso vasca: 78 kg.

Capacità: 247 L.

*Oval Cristalplant bathtub complete with drain pipe fitting and pressure plug, siphon and flexible hose.*

*Weight: 78 kg.*

*Capacity: 247 L.*





Verniciabile esternamente in tutti i colori del nostro campionario  
 Can be externally lacquered in all colors of our collection

H	P	L	art.
78	90	192	SUITE248
78	90	192	SUITE310

Vasca da bagno ovale in Cristalplant con piedini, completa di piletta con sistema di scarico a pressione klik- clak, sifone e tubo flessibile.

Art. SUITE248

Peso vasca: 80 kg.

Capacità: 248 L.

Art. SUITE310

Peso vasca: 80 kg.

Capacità: 310 L.

Oval Cristalplant bathtub with feet, complete with drain with pressure plug, siphon and flexible hose.

Art. SUITE248

Weight: 80 kg.

Capacity: 248 L.

Art. SUITE310

Weight: 80 kg.

Capacity: 310 L.





Verniciabile esternamente in tutti i colori del nostro campionario  
*Can be externally lacquered in all colors of our collection*

H	P	L	art.
60	76	172	EDONIA

Vasca da bagno rettangolare in Cristalplant con piedini, completa di piletta con sistema di scarico a pressione klik- clak, sifone e tubo flessibile.

Peso vasca: 125 kg.

Capacità: 272 L.

*Rectangular Cristalplant bathtub with feet, complete with drain with pressure plug, siphon and flexible hose.*

*Weight: 125 kg.*

*Capacity: 272 L.*

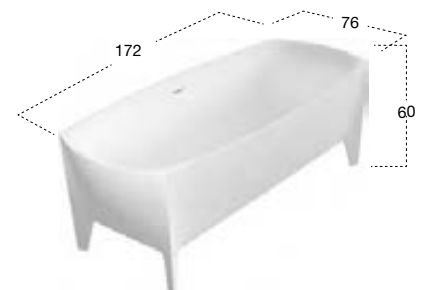



Verniciabile esternamente in tutti i colori del nostro campionario  
*Can be externally lacquered in all colors of our collection*

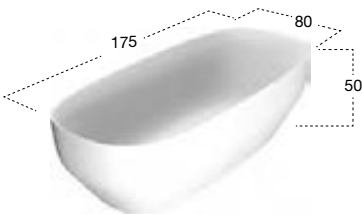

H	P	L	art.
50	80	175	AG04

Vasca da bagno ovale in Cristalplant, completa di piletta con sistema di scarico a pressione clik-clak, sifone e tubo flessibile.  
Peso vasca: 131 kg.  
Capacità: 345 L.

*Oval Cristalplant bathtub complete with drain and pressure plug, siphon and flexible hose.  
Weight: 131 kg.  
Capacity: 345 L.*

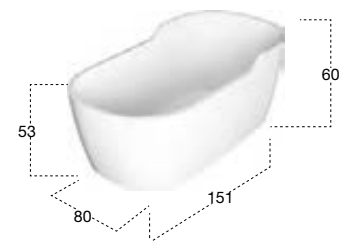

H	P	L	art.
60	80	151	FUNNY WEST

Vasca da bagno ovale in Cristalplant, completa di piletta con sistema di scarico a pressione clik-clak sifone e tubo flessibile.

Peso vasca: 95 kg.

Capacità: 292 L.

*Oval Cristalplant bathtub complete with drain and pressure plug, siphon and flexible hose.*

*Weight: 95 kg.*

*Capacity: 292 L.*





H	P	L	art.
77,2	84	178	WANDA

Vasca da bagno ovale in Ceramilux con schienale, completa di piletta con sistema di scarico a pressione klik-clak, sifone e tubo flessibile.  
Peso vasca: 120 kg.  
Capacità: 384 L.

*Oval Ceramilux bathtub with back rest complete with drain and pressure plug, siphon and flexible hose.  
Weight: 120 kg.  
Capacity: 384 L.*

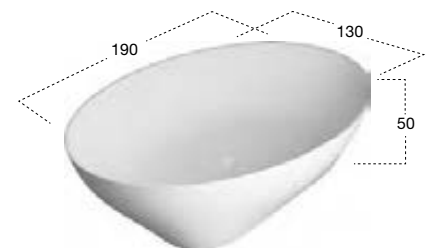

H	P	L	art.
50	130	190	SOLIDEA1

Vasca da bagno ovale in Cristalplant, completa di piletta con sistema di scarico a pressione clik-clak, sifone e tubo flessibile.

Peso vasca: 141 kg.

Capacità: 500 L.

*Oval Cristalplant bathtub complete with drain pipe fitting and pressure plug, siphon and flexible hose.*

*Weight: 141 kg.*

*Capacity: 500 L.*

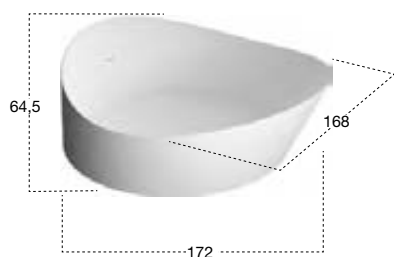

H	P	L	art.
64,5	168	172	DUNE1

Vasca da bagno tonda in Cristalplant, completa di piletta con sistema di scarico a pressione clik-clak, sifone e tubo flessibile.  
Peso vasca: 191 kg.  
Capacità: 430 L.

*Round Cristalplant bathtub complete with drain pipe fitting and pressure plug, siphon and flexible hose.  
Weight: 191 kg.  
Capacity: 430 L.*

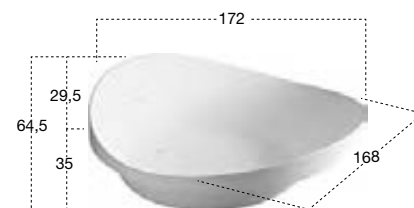
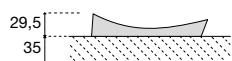

H	P	L	art.
64,5	168	172	DUNE2

Vasca da bagno tonda a semincasso in Cristalplant, completa di piletta con sistema di scarico a pressione klik-clak, sifone e tubo flessibile.

Peso vasca: 142 kg.

Capacità: 430 L.

*Semi-encased round Cristalplant bathtub complete with drain pipe fitting and pressure plug, siphon and flexible hose.*

*Weight: 142 kg.*

*Capacity: 430 L.*



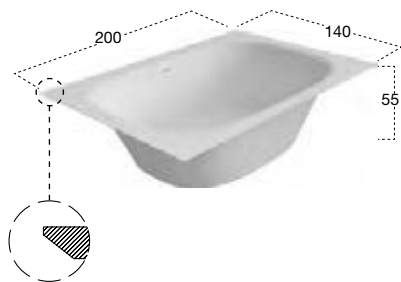

H	P	L	art.
55	140	200	SARTO MAXI2

Vasca da bagno rettangolare freestanding o da incasso in Cristalplant completa di piletta con scarico a pressione klik-clak, sifone e tubo flessibile.  
Peso vasca: 157 kg.  
Capacità: 511 L.

*Rectangular Cristalplant freestanding or encased bathtub, complete with drain and pressure plug, siphon and flexible hose.  
Weight: 157 kg.  
Capacity: 511 L.*

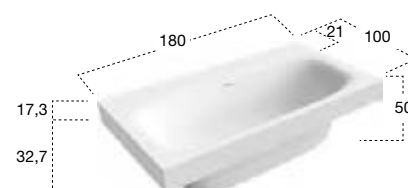
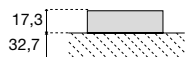

H	P	L	art.
50	100	180	SARTO36

Vasca da bagno rettangolare a semincasso in Cristalplant, con bordo per rubinetteria sul retro, completa di piletta con scarico a pressione klik-clak, sifone e tubo flessibile.

Peso vasca: 152 kg.

Capacità: 290 L.

*Semi-encased rectangular Cristalplant bathtub with back rim for tap mounting, complete with drain and pressure plug, siphon and flexible hose.*

*Weight: 152 kg.*

*Capacity: 290 L.*

## SARTO

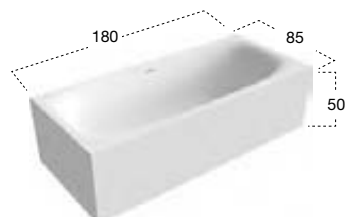

H	P	L	art.
50	85	180	SARTO47

Vasca da bagno rettangolare freestanding in Cristalplant completa di piletta con sistema di scarico a pressione clik-clak, sifone e tubo flessibile.

Peso vasca: 183 kg.

Capacità: 290 L.

*Rectangular Cristalplant freestanding bathtub, complete with drain and pressure plug, siphon and flexible hose.*

*Weight: 183 kg.*

*Capacity: 290 L.*

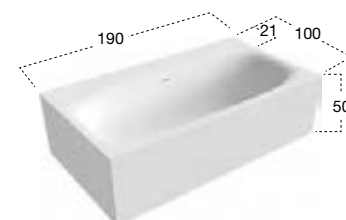

H	P	L	art.
50	100	190	SART017

Vasca da bagno rettangolare freestanding in Cristalplant, con bordo per rubinetteria sul retro, completa di piletta con scarico a pressione clik-clak, sifone e tubo flessibile.

Peso vasca: 203 kg.

Capacità: 290 L.

*Rectangular Cristalplant freestanding bathtub with back rim for tap mounting, complete with drain and pressure plug, siphon and flexible hose.*

*Weight: 203 kg.*

*Capacity: 290 L.*



# SARTO

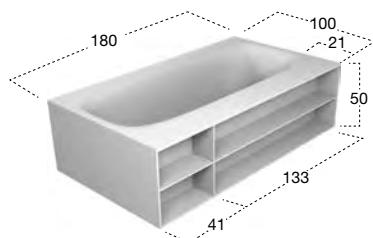

H	P	L	art.
50	100	180	SART053

Vasca da bagno rettangolare in Cristalplant, con vani a giorno frontali dx o sx e piletta con scarico a pressione klik-clak.  
 Peso vasca: 240 kg.  
 Capacità: 290 L.

*Rectangular Cristalplant bathtub with front, right or left open compartments and pressure drain.  
 Weight: 240 kg.  
 Capacity: 290 L.*

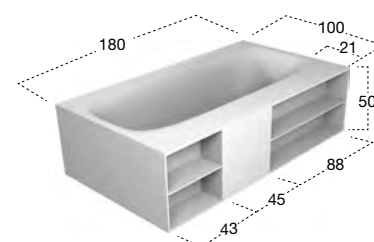

H	P	L	art.
50	100	180	SARTO153

Vasca da bagno rettangolare in Cristalplant con vani a giorno frontali, alloggiamento per rubinetteria dx o sx e piletta con scarico a pressione klik-clak.

Peso vasca: 260 kg.

Capacità: 290 L.

*Rectangular Cristalplant bathtub with front open compartments, right or left tap border and pressure drain.*

*Weight: 260 kg.*

*Capacity: 290 L.*

# SARTORIALE

art. SART015



**SART015** H 50 P 100 L 190

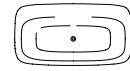
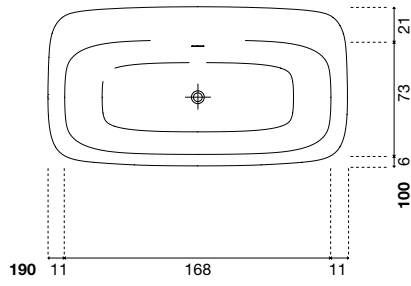

art. SART040/20



**SART040** H 50 P 85 H L 180  
**SART020** H 50 P 85 H L 190

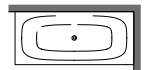
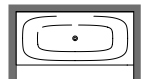
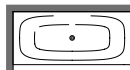
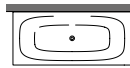
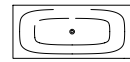
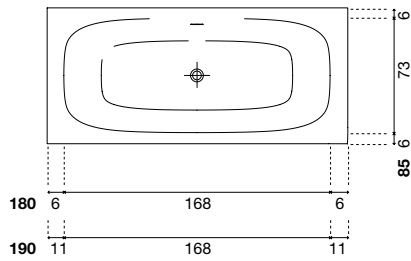

art. SART030/10



**SART030** H 50 P 100 L 180  
**SART010** H 50 P 100 L 190

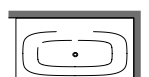
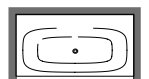
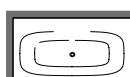
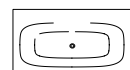
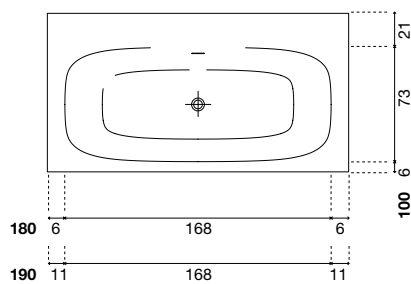

art. SART046



SART046 H 50 P 85 L 180

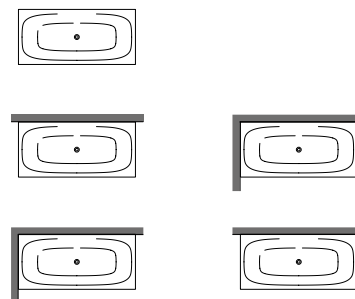
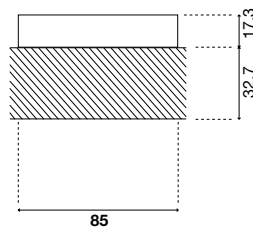
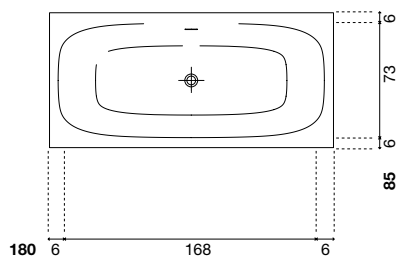

art. SART036



SART036 H 50 P 100 L 180

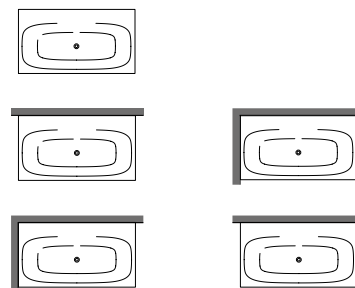
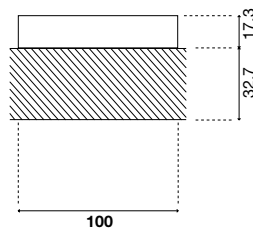
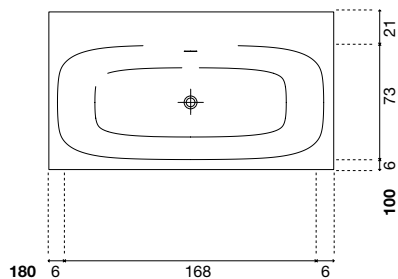

art. SART047/27



SART047 H 50 P 85 L 180  
SART027 H 50 P 85 L 190

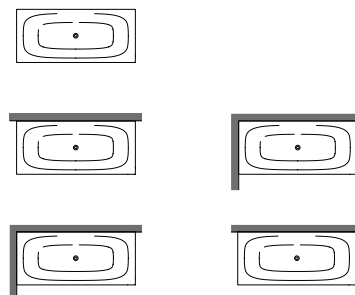
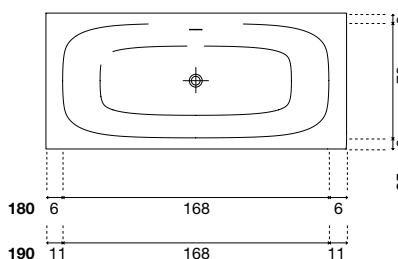



# SARTORIALE

art. SART037/17



**SART037** H 50 P 100 L 180  
**SART017** H 50 P 100 L 190

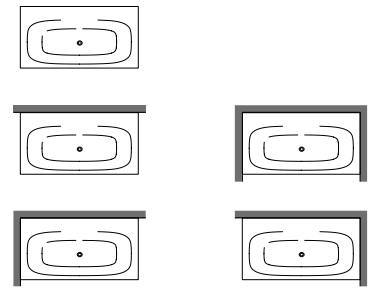
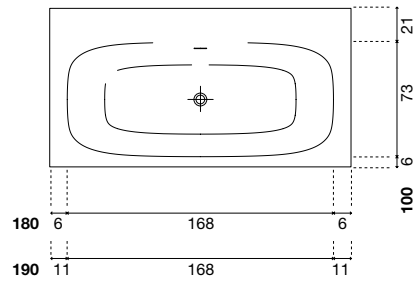

art. SARTO MAXI2



**SARTO MAXI2** H 55 P 140 L 200

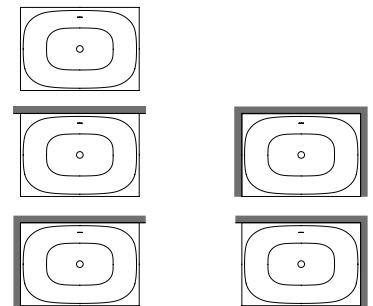
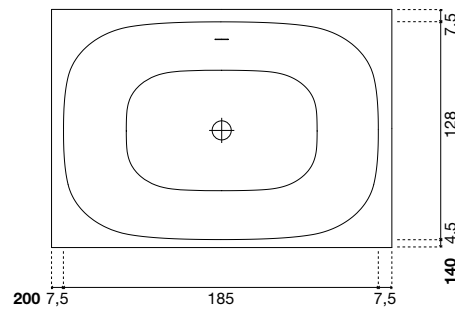

art. SART053



art. **SART053** H 50 P 100 L 180

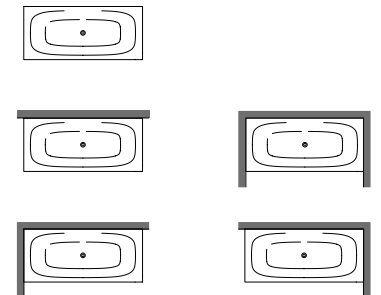
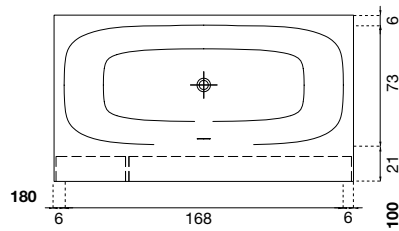

art. SART0153



art. **SART0153** L 180 P 100 H 50

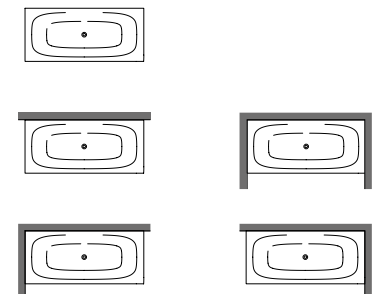
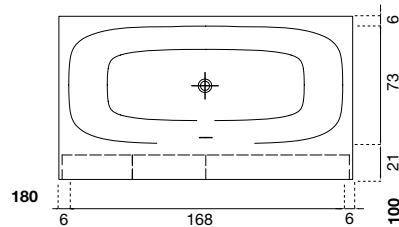

## POSIZIONAMENTO RUBINETTERIA / TAP POSITION

Vista dall'alto e laterale del posizionamento del rubinetto sul bordo da 21 cm lato lungo vasca opzioni **A-B** degli Art. **BK701**, **AY701SA** e **AY701LU**.

Top and side view of tap position on border 21 cm. long side options **A-B** of Art. **BK701**, **AY701SA** and **AY701LU**.

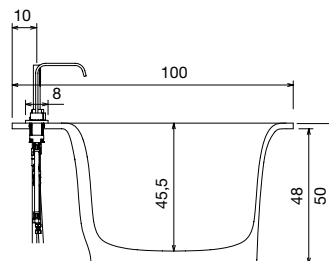
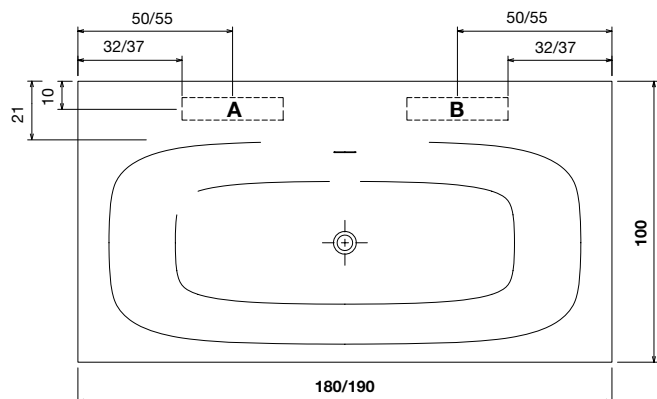

art. BK701

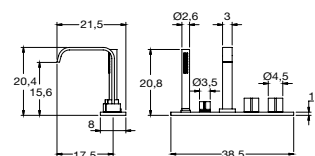

art. AY701SA  
art. AY701LU

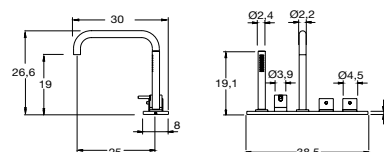

art. ND702LU  
art. ND702GR

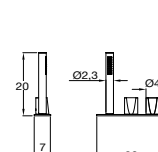

art. BK903N

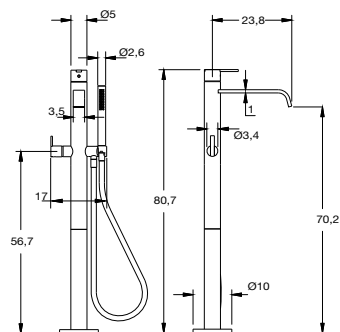

art. AY903SA  
art. AY903LU

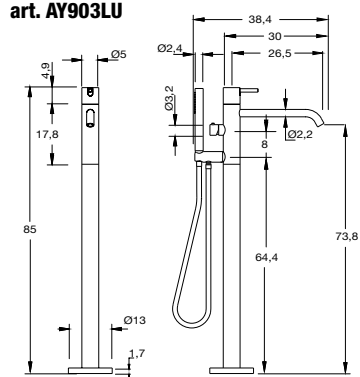

art. ND903LU  
art. ND903GR

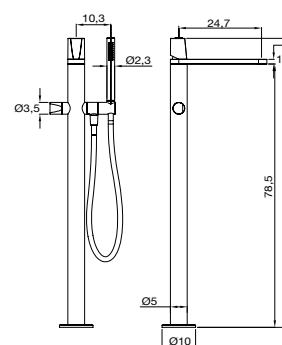

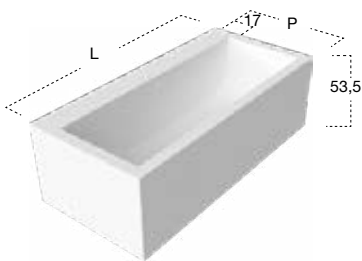

art. BRIDGE

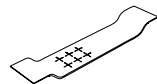

H	P	L	art.
53,5	80	170	BIBLIO22
	90	180	BIBLIO23

Vasca da bagno rettangolare in Corian, con bordo per rubinetteria sul retro, completa di piedini regolabili e piletta con scarico a pressione klik-clak.  
 Art. BIBLIO22  
 Peso vasca: 152 kg.  
 Capacità: 288 L.  
 Art. BIBLIO23  
 Peso vasca: 160 kg.  
 Capacità: 362 L.

*Rectangular Corian bathtub with back rim for tap mounting, complete with regulating feet and drain with pressure plug.*  
 Art. BIBLIO22  
 Weight: 152 kg.  
 Capacity: 288 L.  
 Art. BIBLIO23  
 Weight: 160 kg.  
 Capacity: 362 L.



H	P	L	art.
53,5	80	190	BIBLIO44
	90	200	BIBLIO45

Vasca da bagno rettangolare in Corian, con bordo per rubinetteria sul retro e vani a giorno laterali dx o sx, rivestita su 4 lati con pannelli in multistrato impiallacciati in essenza di legno, completa di piedini regolabili e piletta con scarico a pressione clik-clak.

Art. BIBLIO44

Peso vasca: 135 kg.

Capacità: 288 L.

Art. BIBLIO45

Peso vasca: 152 kg.

Capacità: 362 L.

*Rectangular Corian bathtub with back rim for tap mounting and right or left side open shelves, covered on 4 sides with plywood panels veneered with wood essence complete with regulating feet and drain with pressure plug.*

*Art. BIBLIO44*

*Weight: 135 kg.*

*Capacity: 288 L.*

*Art. BIBLIO45*

*Weight: 152 kg.*

*Capacity: 362 L.*

art. BRIDGE

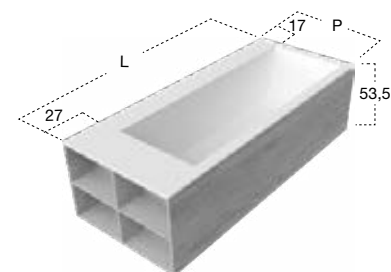



# BIBLIO

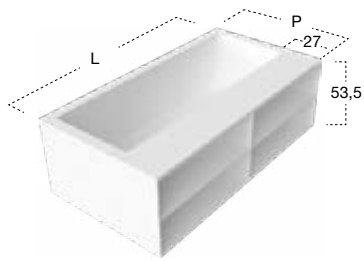

H	P	L	art.
53,5	90	170	BIBLI052
	100	180	BIBLI053

Vasca da bagno rettangolare in Corian, con vani a giorno frontali, completa di piedini regolabili e piletta con scarico a pressione clik-clak.  
 Art. BIBLI052  
 Peso vasca: 128 kg.  
 Capacità: 288 L.  
 Art. BIBLI053  
 Peso vasca: 133 kg.  
 Capacità: 362 L.

*Rectangular Corian bathtub with front open shelves, complete with regulating feet and drain with pressure plug.  
 Art. BIBLI052  
 Weight: 128 kg.  
 Capacity: 288 L.  
 Art. BIBLI053  
 Weight: 133 kg.  
 Capacity: 362 L.*



H	P	L	art.
53,5	90	180	BIBLIO64
	100	190	BIBLIO65

Vasca da bagno rettangolare in Corian, con vani a giorno frontali e bordo per rubinetteria dx o sx, rivestita su 4 lati con pannelli in multistrato impiallacciati in essenza di legno, completa di piedini regolabili e piletta con scarico a pressione clik-clak.

Art. BIBLIO64

Peso vasca: 122 kg.

Capacità: 288 L.

Art. BIBLIO65

Peso vasca: 133 kg.

Capacità: 362 L.

*Rectangular Corian bathtub with front open shelves and right or left side rim for tap mounting, covered on 4 sides with plywood panels veneered with wood essence complete with regulating feet and drain with pressure plug.*

*Art. BIBLIO64*

*Weight: 122 kg.*

*Capacity: 288 L.*

*Art. BIBLIO65*

*Weight: 133 kg.*

*Capacity: 362 L.*

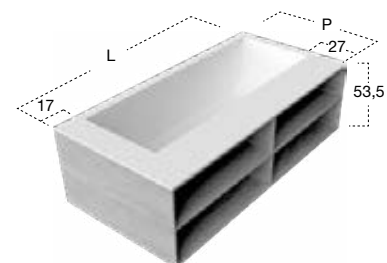





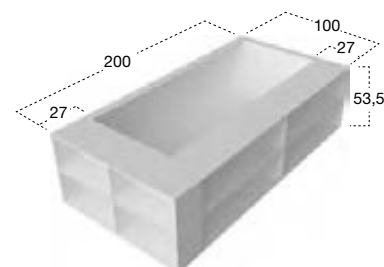

H	P	L	art.
53,5	100	200	BIBLIO103

Vasca da bagno rettangolare in Corian con vani a giorno frontali e laterali, completa di piedini regolabili e piletta con scarico a pressione klik-clak.

Peso vasca: 121 kg.

Capacità: 362 L.

*Rectangular Corian bathtub with front and lateral open shelves, complete with regulating feet and drain with pressure plug.*

*Weight: 121 kg.*

*Capacity: 362 L.*





art. BIBLI030/31/32/33/34/35

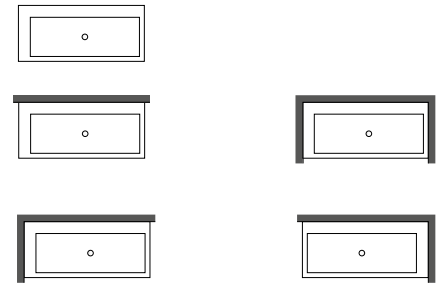
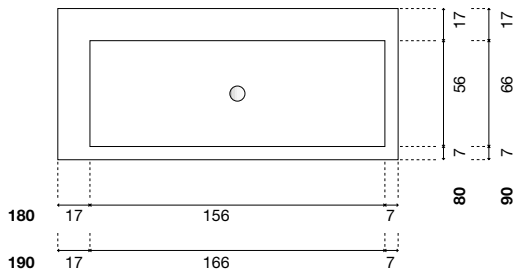

**BIBLI030** H 53,5 P 80 L 180 cm  
**BIBLI031** H 53,5 P 90 L 190 cm

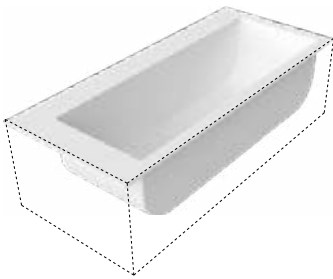

**BIBLI032** H 53,5 P 80 L 180 cm  
**BIBLI033** H 53,5 P 90 L 190 cm



**BIBLI034** H 53,5 P 80 L 180 cm  
**BIBLI035** H 53,5 P 90 L 190 cm



art. BIBLI042/43/44/45

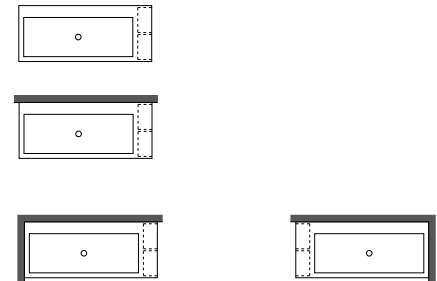
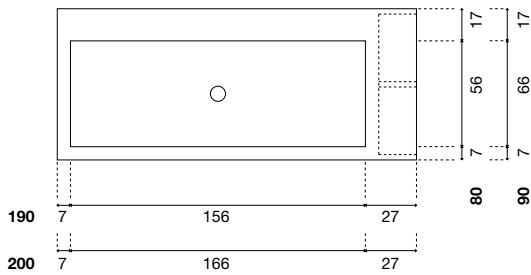

**BIBLI042** H 53,5 P 80 L 190 cm  
**BIBLI043** H 53,5 P 90 L 200 cm

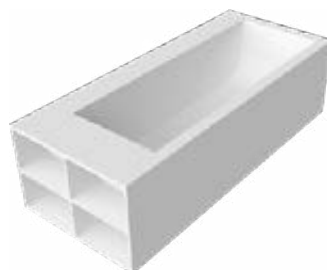

**BIBLI044** H 53,5 P 80 L 190 cm  
**BIBLI045** H 53,5 P 90 L 200 cm

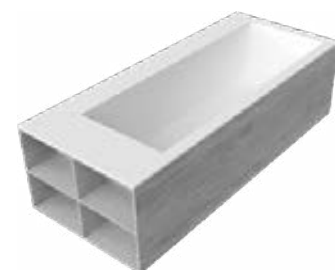

# BIBLIO

art. BIBLI052/53/54/55

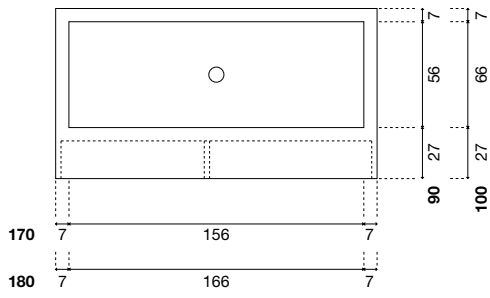

**BIBLI052** H 53,5 P 90 L 170 cm  
**BIBLI053** H 53,5 P 100 L 180 cm

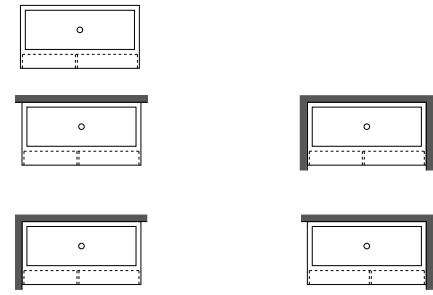

**BIBLI054** H 53,5 P 90 L 170 cm  
**BIBLI055** H 53,5 P 100 L 180 cm



art. BIBLI060/61/62/63/64/65

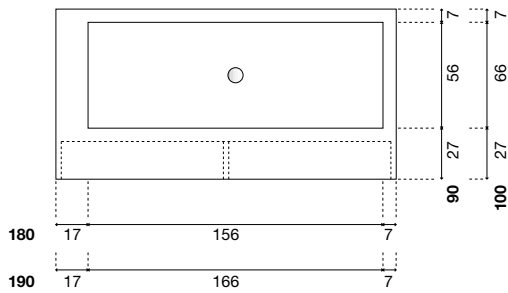

**BIBLI060** H 53,5 P 90 L 180 cm  
**BIBLI061** H 53,5 P 100 L 190 cm

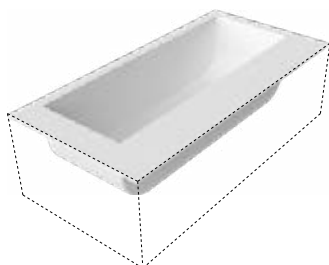

**BIBLI062** H 53,5 P 90 L 180 cm  
**BIBLI063** H 53,5 P 100 L 190 cm

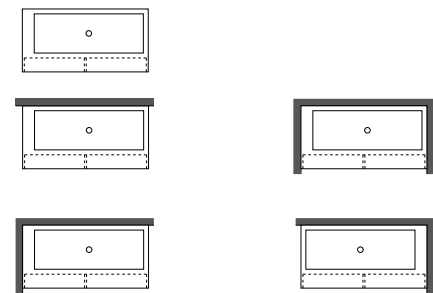

**BIBLI064** H 53,5 P 90 L 180 cm  
**BIBLI065** H 53,5 P 100 L 190 cm



art. BIBLI070/71

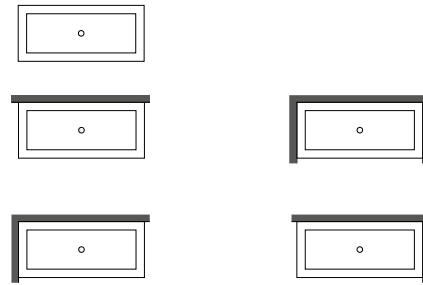
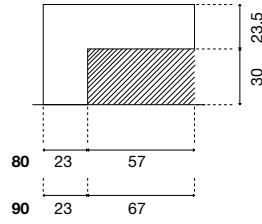
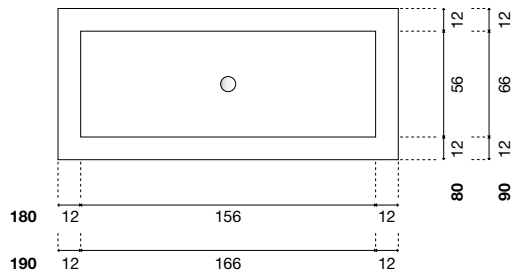

**BIBLI070** H 53,5 P 80 L 180 cm  
**BIBLI071** H 53,5 P 90 L 190 cm

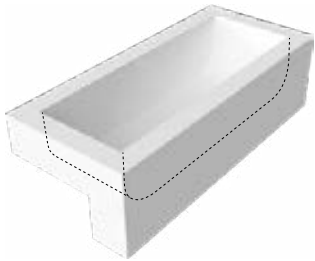

art. BIBLI080/81

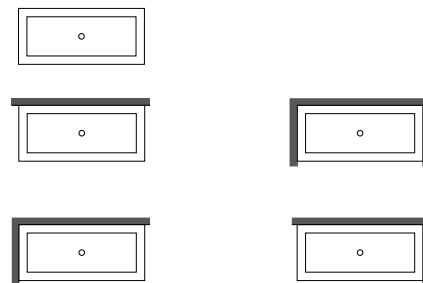
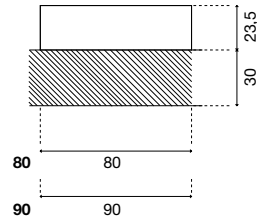
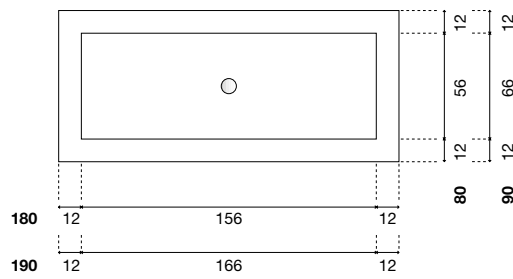

**BIBLI080** H 53,5 P 80 L 180 cm  
**BIBLI081** H 53,5 P 90 L 190 cm

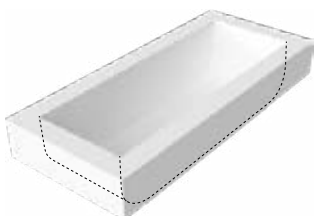



# BIBLIO

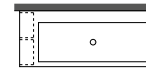
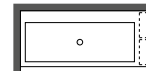
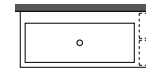
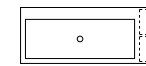
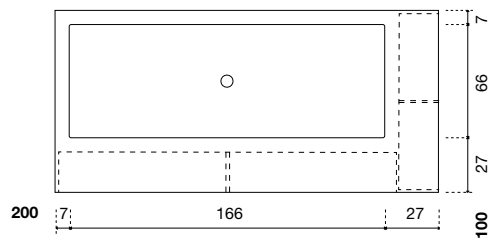

**BIBLIO103** H 53,5 P 100 L 200 cm



Vista dall'alto del posizionamento del rubinetto sul bordo da 17 cm lato lungo vasca opzioni **A-B-C** degli Art. **BK701, BK702, AY701SA, AY701LU, AY702SA, AY702LU, ND702LU** e **ND702GR**.

*Top view of tap position on border 17 cm long side options **A-B-C** of Art. **BK701, BK702, AY701SA, AY701LU, AY702SA, AY702LU, ND702LU** e **ND702GR**.*

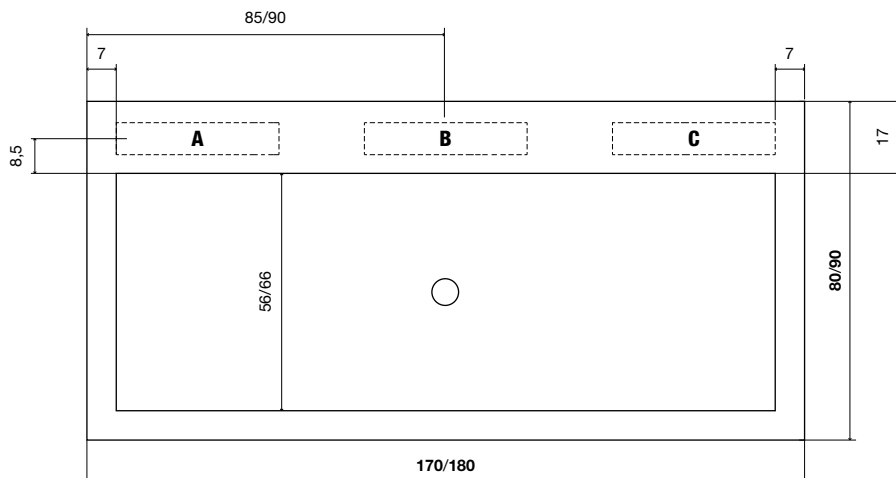

Vista dall'alto e laterale del posizionamento del rubinetto sul bordo da 17 cm lato corto vasca degli Art. **BK701, BK702, AY701SA, AY701LU, AY702SA, AY702LU, ND702LU** e **ND702GR**.

*Top and side view of tap position on center of border 17 cm short side of Art. **BK701, BK702, AY701SA, AY701LU, AY702SA, AY702LU, ND702LU** e **ND702GR**.*

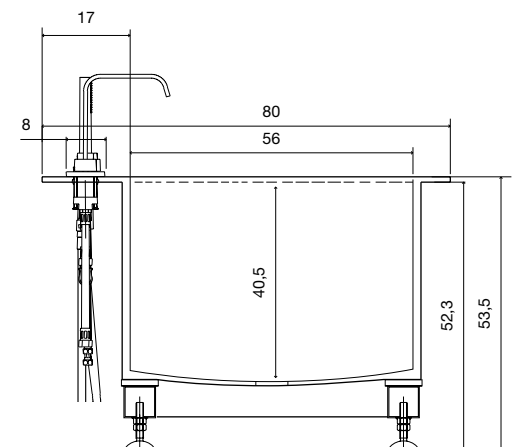
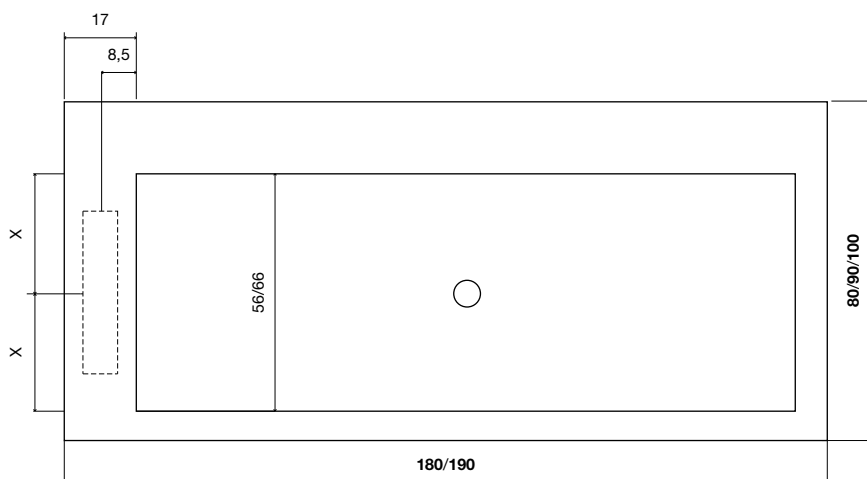



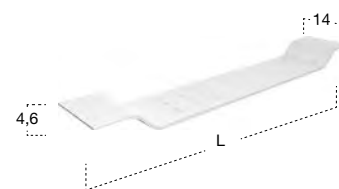

H	P	L	art.
4,6	14	70	BRIDGE10
4,6	14	80	BRIDGE11

Tavoletta sagomata in Corian portaoggetti, per vasca da bagno Art. BIBLIO.

*Corian soap tray for bathtub Art. BIBLIO.*



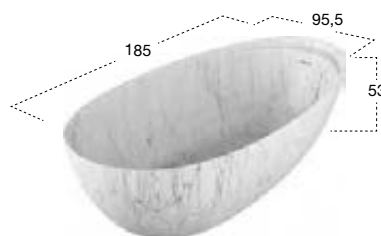

H	P	L	art.	
53	95,5	185	ECLIPSE	Marmo Carrara

Vasca da bagno ovale in pietra, completa di piletta con sistema di scarico a pressione clik-clak.  
 N.B. Per l'ispezione, si consiglia di realizzare un pozzetto esterno (vedere schede tecniche).  
 Peso vasca: 530 kg.  
 Capacità: 350 L.

*Oval stone bathtub complete with drain and pressure plug.  
 P.S. We advise an exterior inspection window (see technical drawings).  
 Weight: 530 kg.  
 Capacity: 350 L.*



Stone Grey



	H	P	L	art.
Pietra Luna / Stone Grey	50	90	185	BAiA

Vasca da bagno ovale in pietra, completa di piletta con sistema di scarico a pressione click-clack.  
N.B. Per l'ispezione, si consiglia di realizzare un pozzetto esterno (vedere schede tecniche).

Peso vasca: 800 kg.

Capacità: 400 L.

*Oval stone bathtub complete with drain and pressure plug.*

*P.S. We advise an exterior inspection window (see technical drawings).*

*Weight: 800 kg.*

*Capacity: 400 L.*









vetro extrachiaro  
extra-clear glass



vetro extrachiaro  
extra-clear glass

BILICO



*vetro riflettente fumé*  
*reflective fumé glass*



vetro extrachiaro  
*extra-clear glass*



BILICO



vetro extrachiaro  
extra-clear glass

art.

BILICO1N

da / a - from / to

H	L
198,3	67 / 77
	78 / 90

Box doccia dx o sx in vetro temperato spess. 8 mm per piatti doccia SUMISURA, ZEROMATT, 00\_XL e 00\_ST tra pareti in nicchia, completo di perno e barra di sostegno.

Right or left shower enclosure in 8 mm tempered glass for shower tray SUMISURA, ZEROMATT, 00\_XL and 00\_ST within a recessed area, complete with pin and supporting bar.

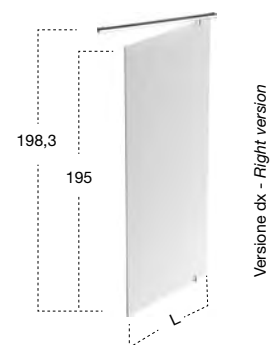

- Rivestimento.  
- Tile Coating.

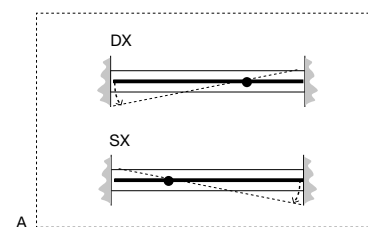
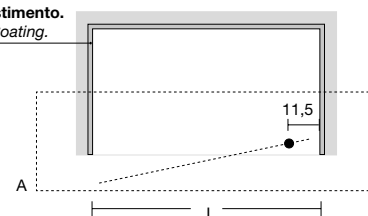

art.

BILICO5N

da / a - from / to

H	L
198,3	117 / 137

Box doccia dx o sx in vetro temperato spess. 8 mm per piatti doccia SUMISURA, ZEROMATT, 00\_XL e 00\_ST tra pareti in nicchia, completo di perno centrale e barra di sostegno.

Right or left shower enclosure in 8 mm tempered glass for shower tray SUMISURA, ZEROMATT, 00\_XL and 00\_ST within a recessed area, complete with center pin and supporting bar.

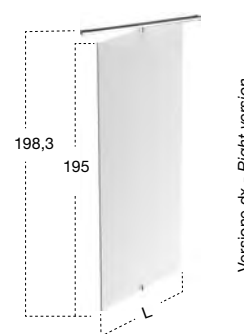

- Rivestimento.  
- Tile Coating.

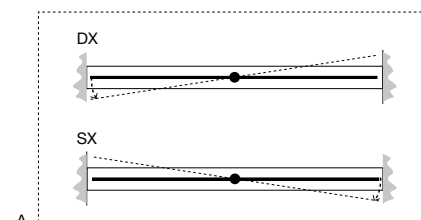
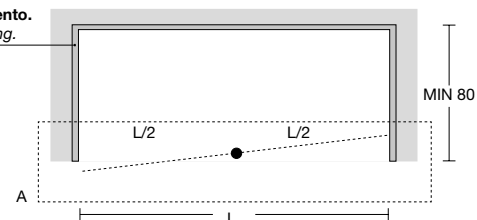

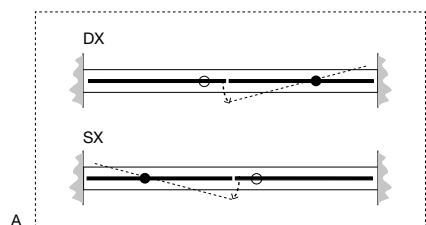
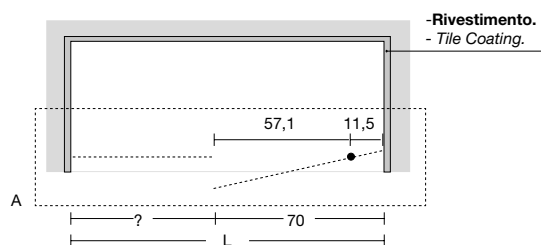
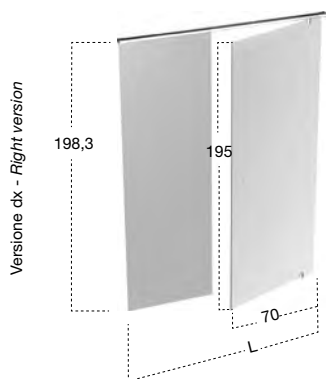

art.

BILICO3N	
	da / a - from / to
H	L
198,3	91 / 117
	118 / 137
	138 / 157
	158 / 177
	178 / 197

Box doccia dx o sx in vetro temperato spess. 8 mm per piatti doccia SUMISURA, ZEROMATT, 00\_XL e 00\_ST tra pareti in nicchia, completo di perno, barra di sostegno e profilo a parete in acciaio inox satinato AISI 304.

Right or left shower enclosure in 8 mm tempered glass for shower tray SUMISURA, ZEROMATT, 00\_XL and 00\_ST within a recessed area, complete with pin, supporting bar and satin stainless steel wall profile AISI 304.

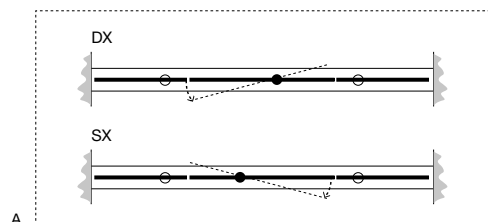
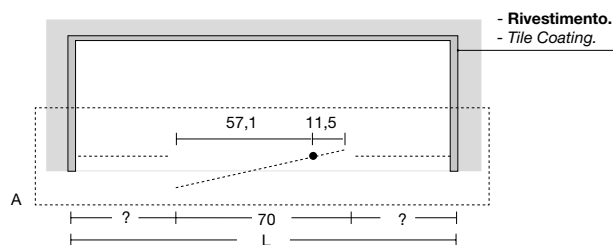
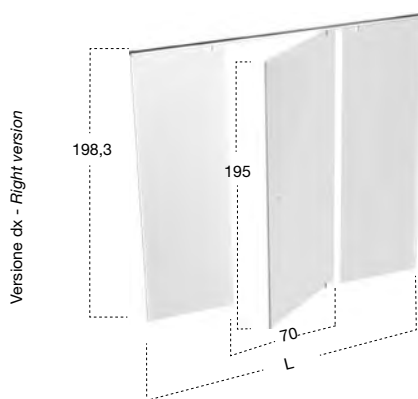

art.

BILICO7N	
	da / a - from / to
H	L
198,3	157 / 177
	178 / 197

Box doccia dx o sx in vetro temperato spess. 8 mm per piatti doccia SUMISURA, ZEROMATT, 00\_XL e 00\_ST tra pareti in nicchia, completo di perno, barra di sostegno e profili a parete in acciaio inox satinato AISI 304.

Right or left shower enclosure in 8 mm tempered glass for shower tray SUMISURA, ZEROMATT, 00\_XL and 00\_ST within a recessed area, complete with pin, supporting bar and wall profiles in satin stainless steel AISI 304.

art.	P
BILICO80AL	67 / 77
BILICO90AL	78 / 90
	da / a - from / to
P	L
67 / 77	89 / 119
	120 / 139
78 / 90	89 / 119
	120 / 139

Box doccia dx o sx in vetro temperato spess. 8 mm per piatti doccia SUMISURA, ZEROMATT, 00\_XL e 00\_ST tra pareti in angolo, completo di perno e barra di sostegno.

Right or left shower enclosure in 8 mm tempered glass for shower tray SUMISURA, ZEROMATT, 00\_XL and 00\_ST within a corner, complete with pin and supporting bar.

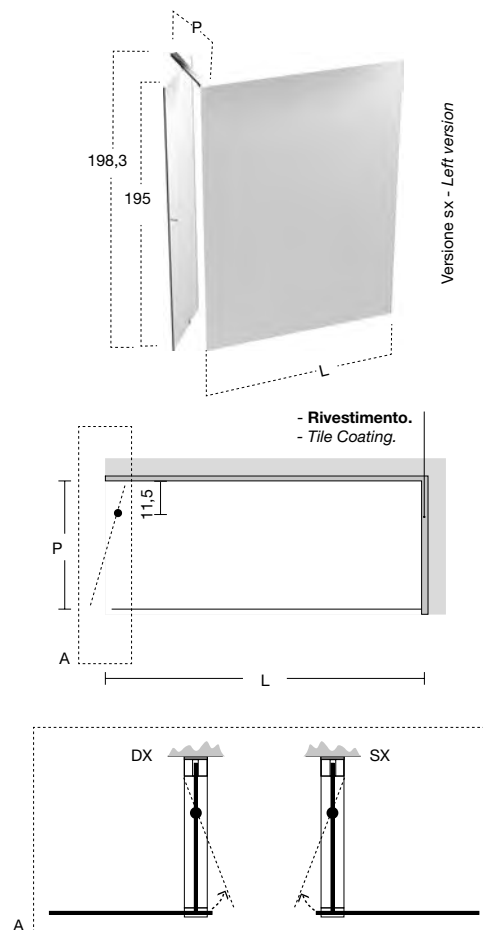

art.	P
BILICO80AF	67 / 77
BILICO90AF	78 / 90
	da / a - from / to
P	L
67 / 77	89 / 119
	120 / 139
	140 / 159
	160 / 179
	180 / 199
78 / 90	89 / 119
	120 / 139
	140 / 159
	160 / 179
	180 / 199

Box doccia dx o sx in vetro temperato spess. 8 mm per piatti doccia SUMISURA, ZEROMATT, 00\_XL e 00\_ST tra pareti in angolo, completo di perno, barra di sostegno e profili a parete in acciaio inox satinato AISI 304.

Right or left shower enclosure in 8 mm tempered glass for shower tray SUMISURA, ZEROMATT, 00\_XL and 00\_ST within a corner, complete with pin, supporting bar and wall profiles in satin stainless steel AISI 304.

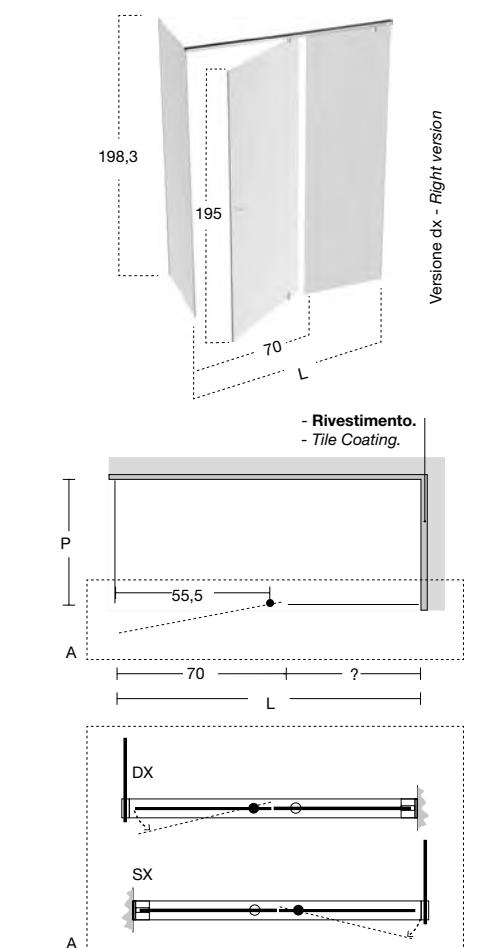



MOLTEPLICI PERSONALIZZAZIONI A RICHIESTA

- Piatto doccia a misura in larghezza e profondità mantenendo la pendenza
- Pendenza costante su tutta la superficie
- Resina anti UV e anti ingiallimento
- Posizionamento scarico variabile
- Possibilità di inserimento doppio scarico
- Bordo rialzato
- Tagli e realizzazioni fuori squadra
- Personalizzazioni su dima e su disegno
- Fresatura per incasso vetro
- Fresatura per installazione a semincasso
- Personalizzazione con inserimento del nome

*MULTIPLE PERSONALIZATIONS ON REQUEST*

- Custom shower tray in length and depth while maintaining the slope*
- Constant slope across the surface*
- Anti UV and anti yellowing resin*
- Variable drain position*
- Double drain available*
- Raised edge*
- Cuts and out of square production*
- Customizations on template and drawing*
- Milling for glass insertion*
- Milling for semi encased installation*
- Customized with name*

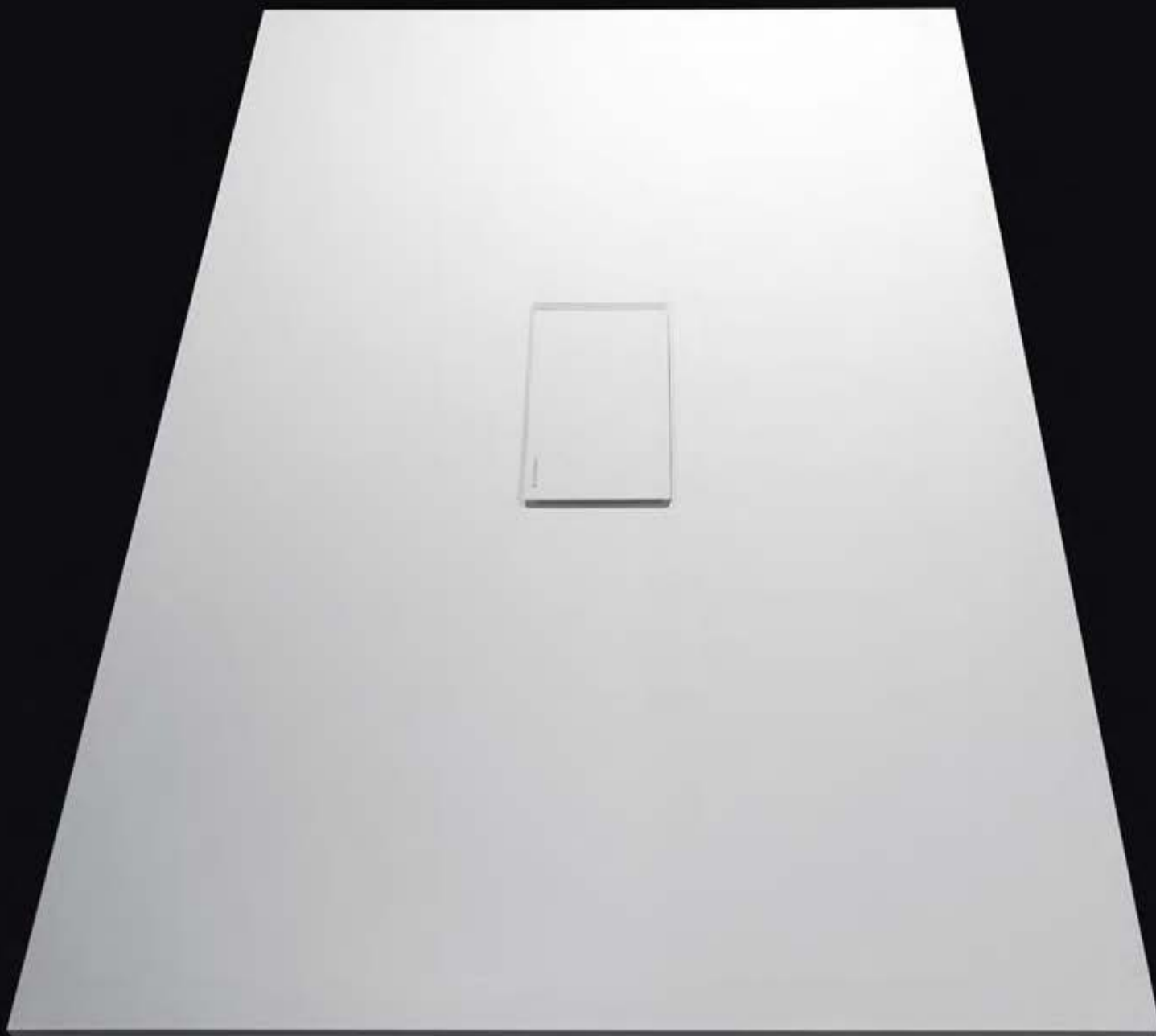



art.	P
SM_80	70 / 80
SM_90	81 / 90
SM_100	91 / 100
SM_110	101 / 110
SM_120	111 / 120

H	L
2	70 / 80
	81 / 90
	91 / 100
	101 / 110
	111 / 120
	121 / 130
	131 / 140
	141 / 150 **
	151 / 160 **
	161 / 170 **
	171 / 180 **
	181 / 190 **
	191 / 200 **
	201 / 210 **
	211 / 220 **

Piatto doccia rettangolare a misura da appoggio (A), da incasso (B) o da semincasso (\*C) in Moodlight spess. 2 cm, completo di sifone e piletta con scarico libero posizionato al centro, con pendenza costante su tutta la superficie.

\* N.B. Lavorazione su richiesta.

*Rectangular top mount (A), encased (B) or semi encased (\*C) shower tray in Moodlight 2 cm thick, complete with siphon and open centered drain, with a constant slope across the surface.*

\* P.S. Manufacturing upon request.

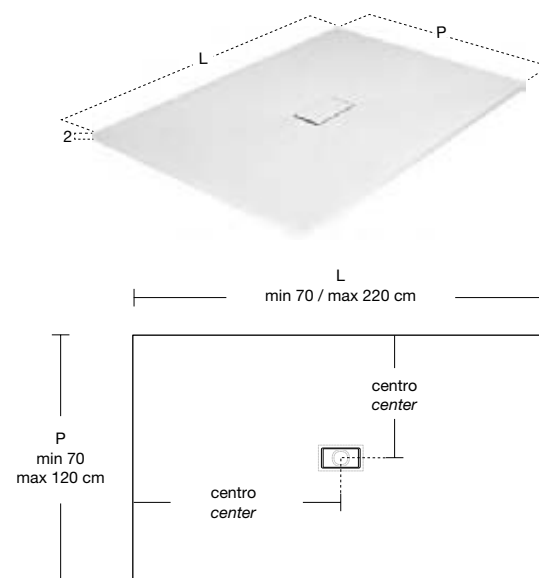

\*\* N.B. Su richiesta è possibile inserire un secondo scarico completo di piletta sifonata.  
P.S. Upon request it is possible to have a second drain complete with trap and plug.

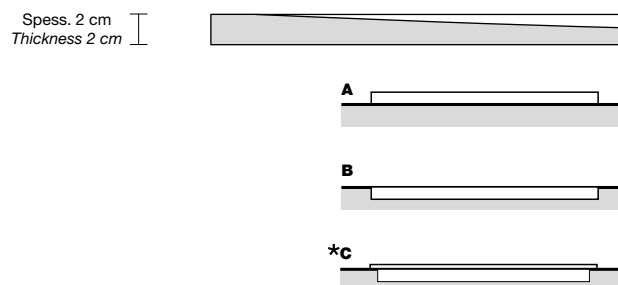

Per personalizzazioni diverse da quanto indicato si prega di consultare l'azienda / *For customization other than that indicated please consult the company*

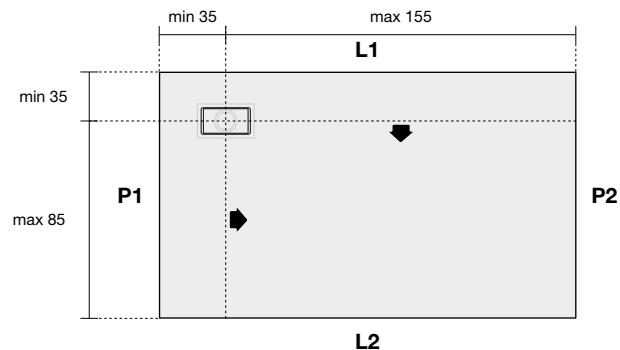

**POSIZIONE SCARICO VARIABILE A RICHIESTA**

La larghezza massima del piatto doccia è di L 220 cm, considerando che la massima estensione di pendenza dal centro piletta è di L 155 cm, è possibile posizionare lo scarico decentrato dove necessita, rispettando le misure minime e massime riportate nello schema.

**DRAIN POSITION VARIABLE ON REQUEST**

*The maximum width of the shower tray is L 220 cm, considering the maximum slope from the center of the drain is L 155 cm, so the drain can be positioned where necessary, considering the minimum and maximum measurements reported in the diagram.*

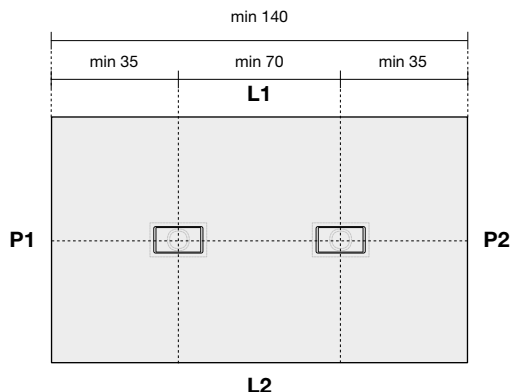

**POSIZIONE DOPPIO SCARICO VARIABILE A RICHIESTA**

Rispettando le misure minime in profondità (P1/P2) min 35 cm riportate nello schema precedente, è possibile posizionare in larghezza (L1/L2) sullo stesso asse un doppio scarico su un L min 140 cm.

**VARIABLE POSITION OF DOUBLE DRAIN UPON REQUEST**

*It is possible to include a second drain on a minimum L 140 cm, considering the minimum measurements in depth P1/P2 min 35 cm shown in the diagram and in length L1/L2 along the same axis.*



**PER OGNI PERSONALIZZAZIONE È NECESSARIO FORNIRE LA DIMA O UN DISEGNO DETTAGLIATO / FOR ANY CUSTOMIZATION YOU MUST PROVIDE THE COMPANY A TEMPLATE OR A DETAILED DRAWING:**

È possibile realizzare fuori squadra, tagli, sagome su disegno (file DXF o DWG) o su dima.

*It is possible to produce out of square, cuts, shapes with a drawing (file in DXF or DWG) or with template.*

ESEMPI DI PERSONALIZZAZIONI / EXAMPLE OF CUSTOMIZATION:

SAGOMA QUADRATA / SQUARE SHAPE

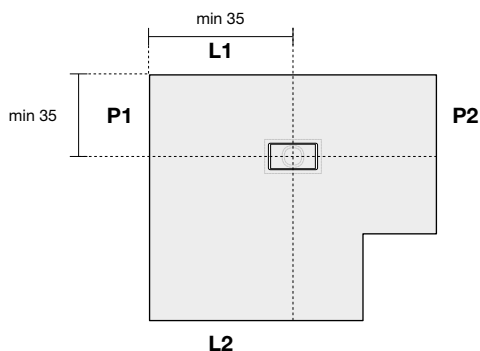

TAGLIO OBLIQUO / OBLIQUE CUTTING

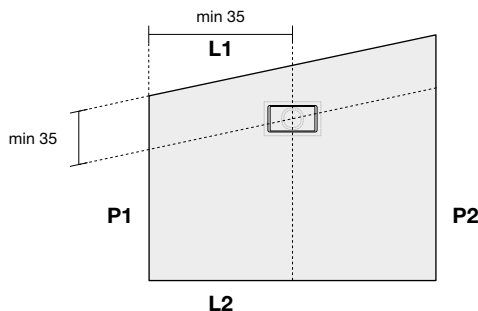

SAGOMA CURVA / CURVED TEMPLATE

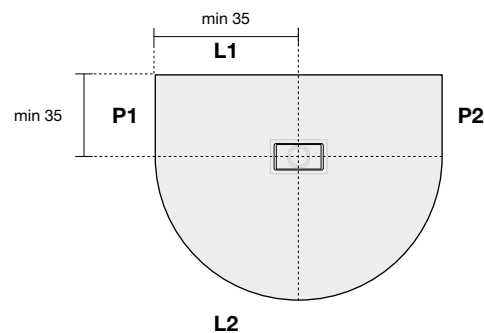

È possibile realizzare lavorazioni personalizzate sui lati del piatto quali, fresature o bordi rialzati.

*On request milling or raised edges can be produced.*

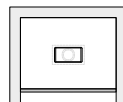

1 lato / 1 side

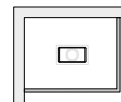

2 lati / 2 sides

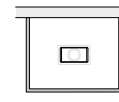

3 lati / 3 sides

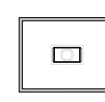

4 lati / 4 sides

ESEMPI DI LAVORAZIONI / EXAMPLES OF WORKMANSHIP:

FRESATURA PER INCASSO VETRO PER OGNI LATO

MILLING FOR GLASS INSERTION ON EACH SIDE

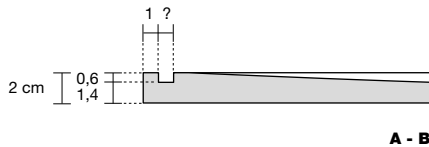

A - B

FRESATURA PER INSTALLAZIONE A SEMINCASSO PER OGNI LATO

MILLING FOR SEMI ENCASED INSTALLATION ON EACH SIDE

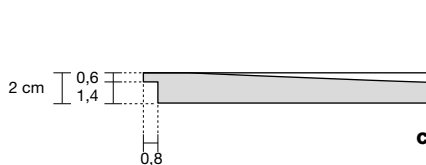

C

BORDO RIALZATO PER OGNI LATO

RAISED EDGE ON EACH SIDE

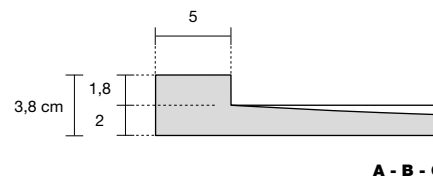

A - B - C

ESEMPI DI INSTALLAZIONE / EXAMPLES OF INSTALLATION:



APPOGGIO / TOP MOUNT

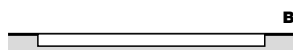

INCASSO / ENCASED

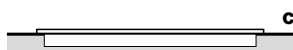

SEMINCASSO / SEMI ENCASED





vetro extrachiaro  
extra-clear glass

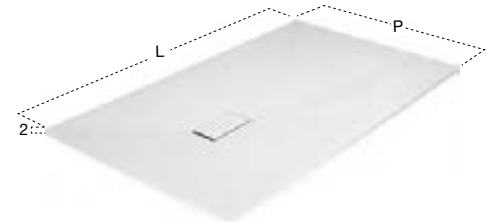

N.B. Per vetri - *For shower enclosures.*

Art. COMBI20 - Art. COMBI120 - Art. COMBI70 - Art. COMBI80  
 Art. COMBI90 - Art. COMBI170 - Art. COMBI180 - Art. COMBI190

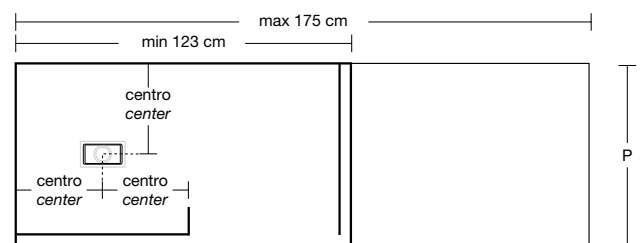

Versione dx - *Right version*

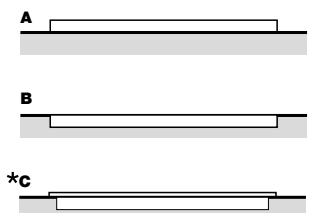

art.	P
SM_COMBI70	70
SM_COMBI80	80
SM_COMBI90	90
H	L
2	123
	136
	149
	162
	175

Piatto doccia rettangolare dx o sx da appoggio (A), da incasso (B) o da semincasso (\*C) in Moodlight spess. 2 cm, completo di sifone e piletta con scarico libero.

\* N.B. Lavorazione su richiesta.

*Right or left rectangular top mount (A), encased (B) or semi encased (\*C) shower tray in Moodlight 2 cm thick, complete with siphon and open drain.*

\* P.S. Manufacturing upon request.



vetro extrachiaro  
extra-clear glass

art.

COMBI1

Asta distanziale in acciaio inox satinato AISI 304, per fissaggio a parete vetri box doccia  
Art. COMBI20 e Art. COMBI120.

*Satin stainless steel AISI 304 shower bar for wall to glass shower cabin fitting Art. COMBI20 and Art. COMBI120.*



art. H

COMBI20 195

COMBI120 220

Per piatti doccia  
For shower trays

P	L	L
20	66	123
	79	136
	92	149
	105	162
	118	175

Box doccia dx o sx in vetro temperato spess. 8 mm solo per piatti doccia Art. SM\_COMBI tra pareti in nicchia, completo di profilo a parete.

*Right or left shower enclosure in 8 mm tempered glass only for shower trays Art. SM\_COMBI within a recessed area complete with wall profiles.*

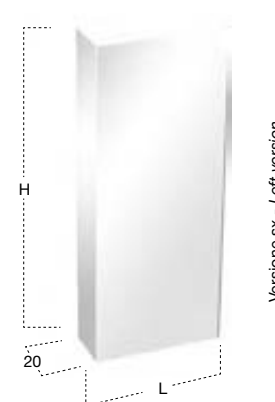

art. H P

COMBI70 195 70

COMBI80 195 80

COMBI90 195 90

COMBI170 220 70

COMBI180 220 80

COMBI190 220 90

Per piatti doccia  
For shower trays

P	L	P	L
67,5 / 77,5 / 87,5	120,5	70 / 80 / 90	123
	133,5		136
	146,5		149
	159,5		162
	172,5		175

Box doccia dx o sx in vetro temperato spess. 8 mm solo per piatti doccia Art. SM\_COMBI tra pareti in angolo, completo di profili a parete e distanziale in acciaio inox satinato AISI 304.

*Right or left shower enclosure in 8 mm tempered glass only for shower trays Art. SM\_COMBI within a corner complete with wall profile and satin stainless steel AISI 304 bar.*

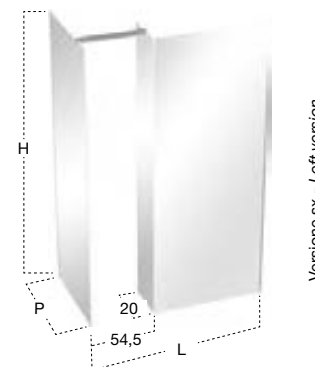

Versione sx - Left version





Vetro extrachiaro  
Extra-clear glass

Vetro acidato  
Acid glass

Vetro bronzo  
Bronze glass

Vetro fumé  
Fumé glass

Vetro riflettente fumé  
Reflective fumé glass



Modello e design registrato, brevetto depositato  
Registered model and design, patent filed

P	H	L	art.
88,5	3,7	173,5	OX88CMBS

Piatto doccia rettangolare dx o sx da appoggio (A) o da incasso (B) solo per box doccia  
Art. ISOLA88, completo di sifone con pedana in Corian composta da doghe dritte e irregolari  
removibili.

N.B. Predisposto per soffione Art. SHAWA2.

Right or left rectangular top mount (A) or encased (B) Corian shower tray only for shower  
enclosures Art. ISOLA88, complete with trap; footboard made of straight and irregular removable  
slabs.

P.S. Prepared for showerhead Art. SHAWA2.

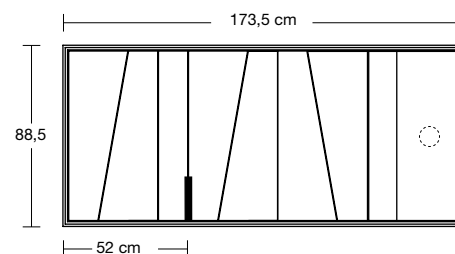

Versione sx - Left version

N° 01 Scarico centrale (Larghezza diviso 2)  
N° 01 Central drain (Length divided by 2)



P	H	L	art.
86,3	197,5	171,3	ISOLA88

Box doccia dx o sx ad isola in vetro temperato spess. 8 mm solo per piatto doccia  
Art. OX88,5COMBI e Art. OX88CMBS completo di distanziale in acciaio inox satinato AISI 304.

Right or left freestanding shower enclosure in tempered glass 8 mm thick only for shower trays  
Art. OX88,5COMBI and Art. OX88CMBS, complete with satin stainless steel AISI 304 bar.

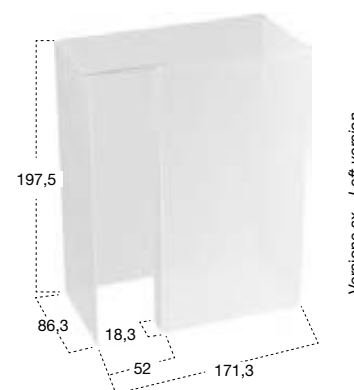





Vetro extrachiaro  
Extra-clear glass

Vetro acidato  
Acid glass

Vetro bronzo  
Bronze glass

Vetro fumé  
Fumé glass

Vetro riflettente fumé  
Reflective fumé glass



Modello e design registrato, brevetto depositato  
Registered model and design, patent filed

P	H	L	art.
88,5	3,7	173,5	0X88,5COMBI

Piatto doccia rettangolare dx o sx da appoggio (A) o da incasso (B) solo per box doccia Art. PENISOLA88 e Art. ISOLA88, completo di sifone con pedana in Corian composta da doghe dritte e irregolari removibili.

Right or left rectangular top mount (A) or encased (B) Corian shower tray only for shower enclosures Art. PENISOLA88 and Art. ISOLA88, complete with trap; footboard made of straight and irregular removable slabs.

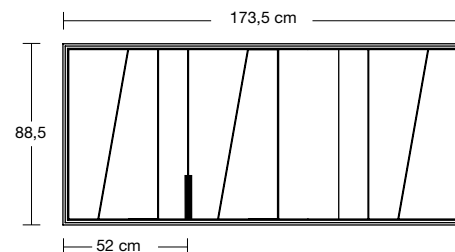

Versione sx - Left version  
N° 02 Scarichi (Larghezza diviso 3)  
N° 02 Drains (Length divided by 3)



Versione sx - Left version

P	H	L	art.
86,3	197,5	171,3	PENISOLA88

Box doccia dx o sx a penisola in vetro temperato spess. 8 mm solo per piatto doccia Art. 0X88,5COMBI, completo di profili a parete e distanziale in acciaio inox satinato AISI 304.

Right or left shower enclosure in tempered glass 8 mm thick only for shower trays Art. 0X88,5COMBI, complete with wall profiles and satin stainless steel AISI 304 bar.

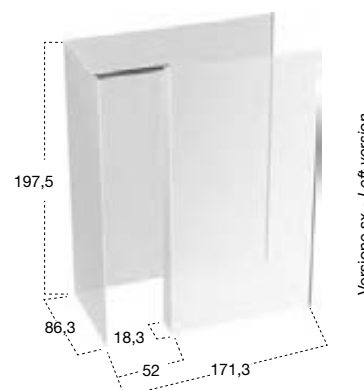

Versione sx - Left version





SOFFIONI / OVERHEAD SHOWERS



**AZIMUT** design GI-RA

Modello e design registrato, brevetto depositato  
*Registered model and design, patent filed*



acciaio inox satinato

*satin stainless steel*



grafite

*graphite*

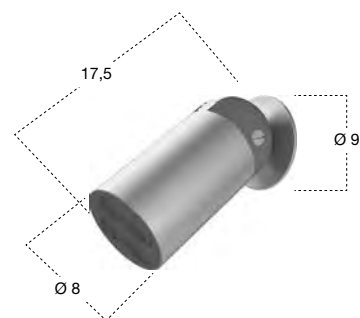

H	P	Ø	art.
9	17,5	9	AZIMUT

Soffione a parete o a soffitto in acciaio inox AISI 304 e Delrin nero, con regolazione del getto.

*Wall or ceiling showerhead in stainless steel AISI 304 and black Delrin, with jet regulation.*



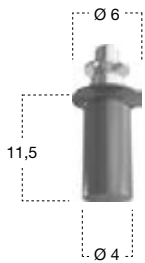

H	Ø	art.
11,5	6	KOSMO

Soffione a soffitto in acciaio inox satinato AISI 304 e Delrin nero.

*Ceiling shower in satin stainless steel AISI 304 and black Delrin.*

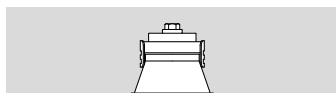

H	Ø	art.
6	8	ZENIT10

Struttura ad incasso a soffitto in alluminio nero con soffione in Delrin nero.

*Black Delrin shower with ceiling encasing structure in black aluminum.*





Tutti i soffioni con illuminazione a LED RGB sono dotati di telecomando waterproof IP66 che può essere utilizzato comodamente sotto la doccia.

*All overhead showers with RGB LED lighting come with an IP66 waterproof remote control that can easily be used under the shower.*



H	Ø	art.
30	25,3	IRIDE

Soffione a soffitto in acciaio inox satinato AISI 304, completo di diffusore in acrilico opalino e illuminazione LED RGB comprensivo di telecomando waterproof.

*Ceiling mounted showerhead in stainless steel AISI 304, complete with mat acrylic light diffuser, LED RGB lighting and waterproof remote control.*





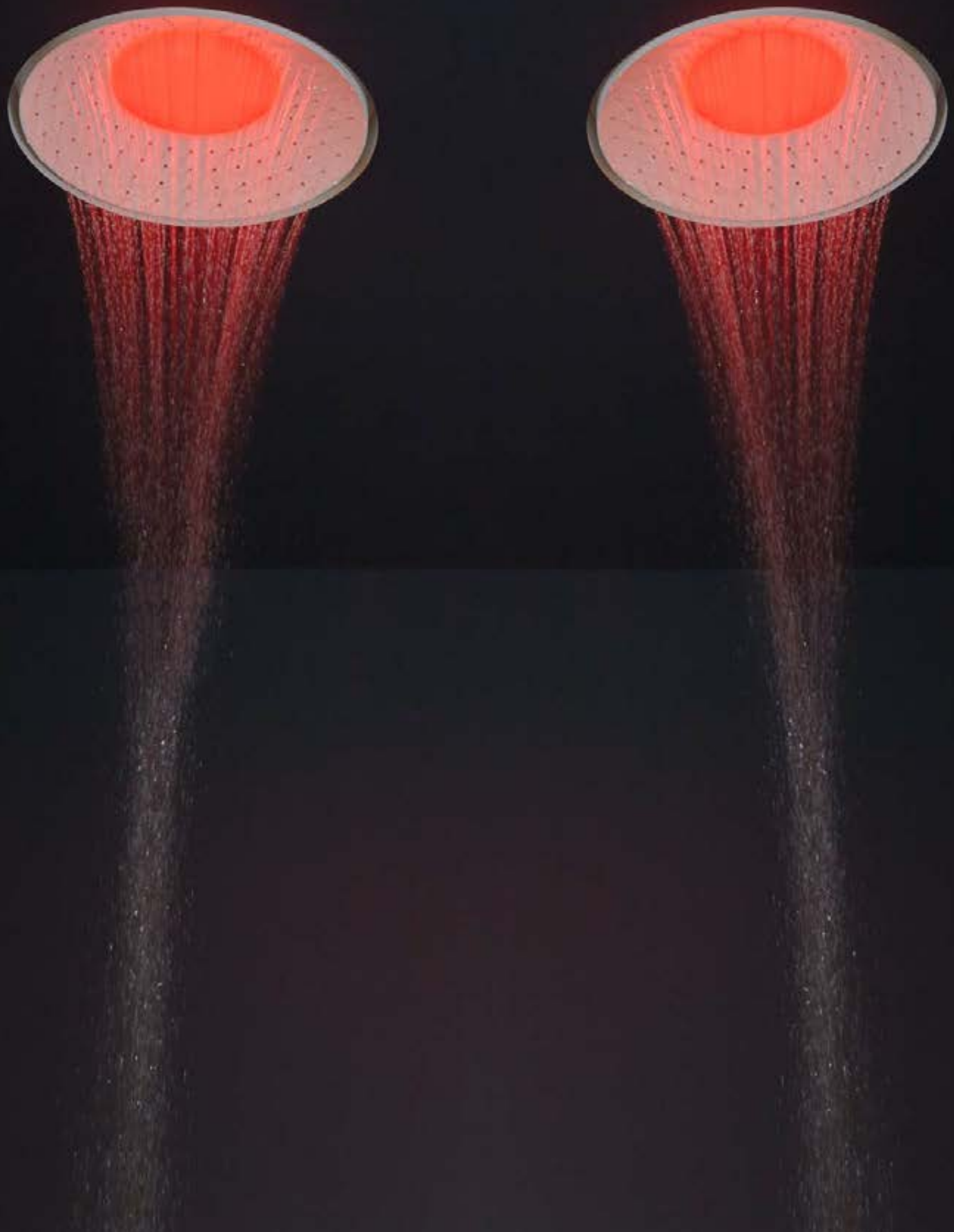

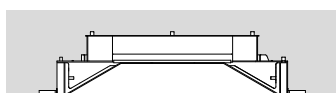

Tutti i soffioni con illuminazione a LED RGB sono dotati di telecomando waterproof IP66 che può essere utilizzato comodamente sotto la doccia.

*All overhead showers with RGB LED lighting come with an IP66 waterproof remote control that can easily be used under the shower.*

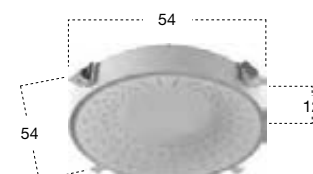

H	P	L	art.
12	54	54	LUMEN

Soffione ad incasso a soffitto in acciaio AISI 304 con illuminazione a LED RGB comprensivo di telecomando waterproof.

*Ceiling encasing showerhead in stainless steel AISI 304 with RGB LED lighting and waterproof remote control.*

# METEO\_OUT design Nevio Tellatin

Modello e design registrato, brevetto depositato  
*Registered model and design, patent filed*



Tutti i soffioni con illuminazione a LED RGB sono dotati di telecomando waterproof IP66 che può essere utilizzato comodamente sotto la doccia.

*All overhead showers with RGB LED lighting come with an IP66 waterproof remote control that can easily be used under the shower.*

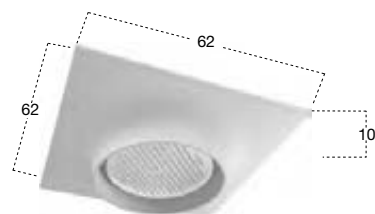
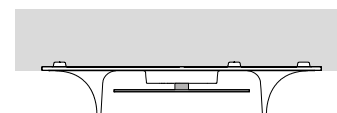

H	P	L	art.	art.
10	62	62	METEO_OUT	METEO_OUTL Con illuminazione a led / With led lighting

Struttura ad incasso a soffitto in Flumood con soffione in acciaio inox satinato AISI 304, con possibilità di illuminazione a LED RGB comprensiva di telecomando waterproof.

*Ceiling encased Flumood frame with satin stainless steel AISI 304 showerhead with possible LED RGB lighting complete with waterproof remote control.*

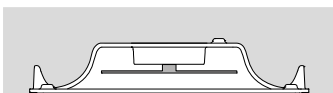

Tutti i soffioni con illuminazione a LED RGB sono dotati di telecomando waterproof IP66 che può essere utilizzato comodamente sotto la doccia.



*All overhead showers with RGB LED lighting come with an IP66 waterproof remote control that can easily be used under the shower.*

H	P	L	art.	art.
11	62	62	METEO_IN	METEO_INL Con illuminazione a led / With led lighting

Struttura ad incasso a soffitto in Flumood con soffione in acciaio inox satinato AISI 304, con possibilità di illuminazione a LED RGB comprensiva di telecomando waterproof.

*Ceiling encased Flumood frame with satin stainless steel AISI 304 showerhead with possible LED RGB lighting complete with waterproof remote control.*

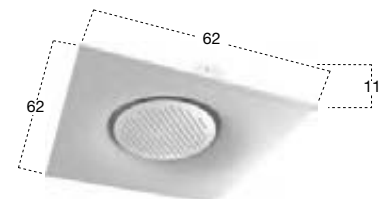







1



2



3



4



5



6



7



8



9



10

**METEO** design Nevio Tellatin

Modello e design registrato, brevetto depositato  
*Registered model and design, patent filed*





## WATERPROOF REMOTE CONTROL

Tutti i soffioni con illuminazione a LED RGB sono dotati di telecomando waterproof IP66 che può essere utilizzato comodamente sotto la doccia.

*All overhead showers with RGB LED lighting come with an IP66 waterproof remote control that can easily be used under the shower.*



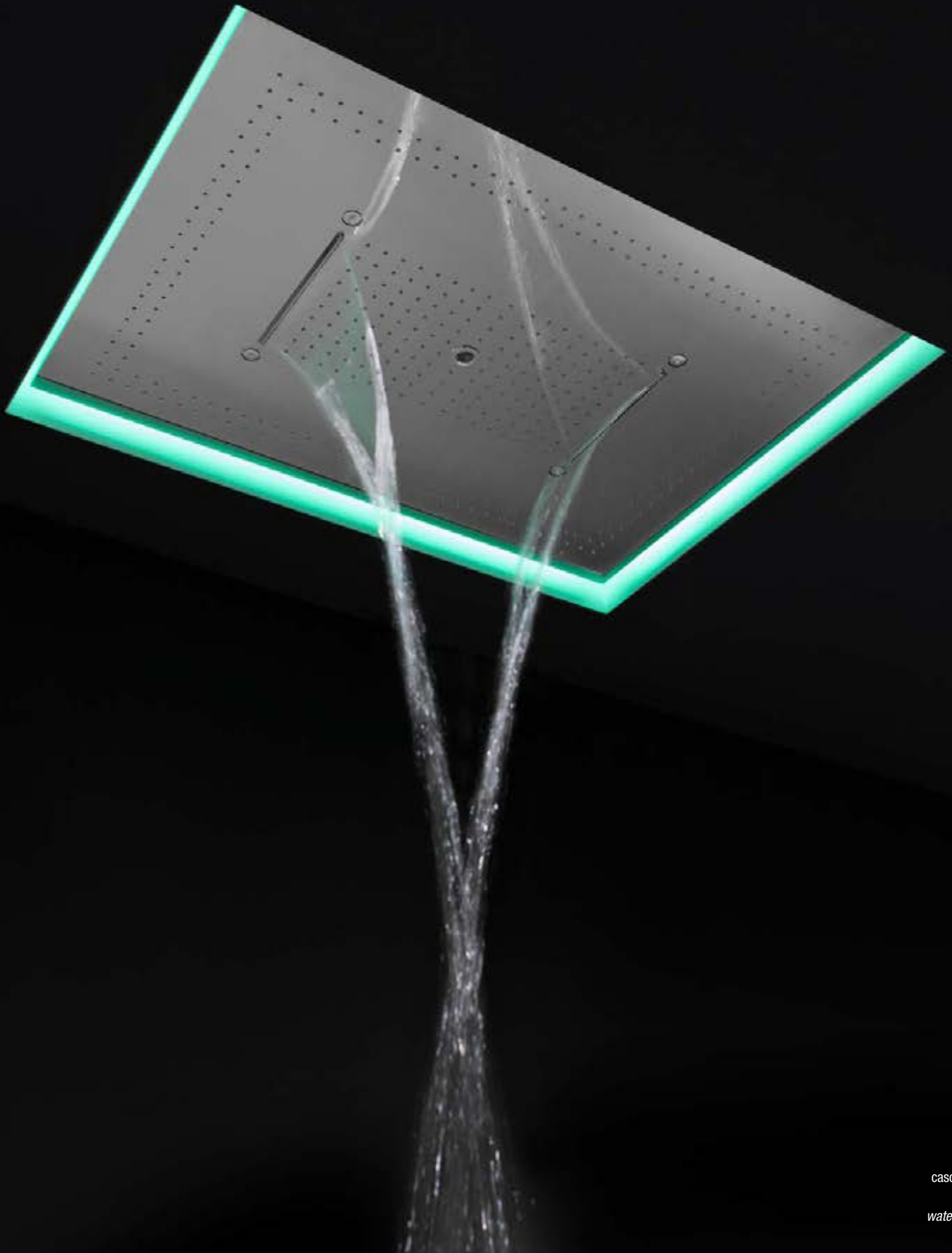

*cascata*

*waterfall*



doccia perimetrale  
*perimeter shower*



doccia centrale  
*central shower*



chiodo  
*jet*



nebulizzatori  
*nebulizer*





Tutti i soffioni con illuminazione a LED RGB sono dotati di telecomando waterproof IP66 che può essere utilizzato comodamente sotto la doccia.

*All overhead showers with RGB LED lighting come with an IP66 waterproof remote control that can easily be used under the shower.*



H	P	L	art.
11	75	100	METEOXXL

Soffione ad incasso a soffitto in acciaio AISI 304 con doccia centrale e perimetrale, doppia cascata, getto a chiodo, nebulizzatori e possibile illuminazione a LED RGB comprensiva di telecomando waterproof.

N.B. Necessita di deviatore a cinque vie.

*Ceiling encased showerhead in stainless steel AISI 304 with central and perimeter shower, double waterfall, hard center jet, nebulizers and possible LED RGB lighting complete with waterproof remote.*

*P.S. Requires five way diverter.*

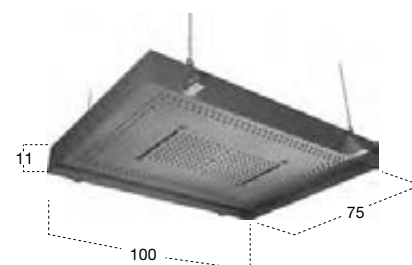





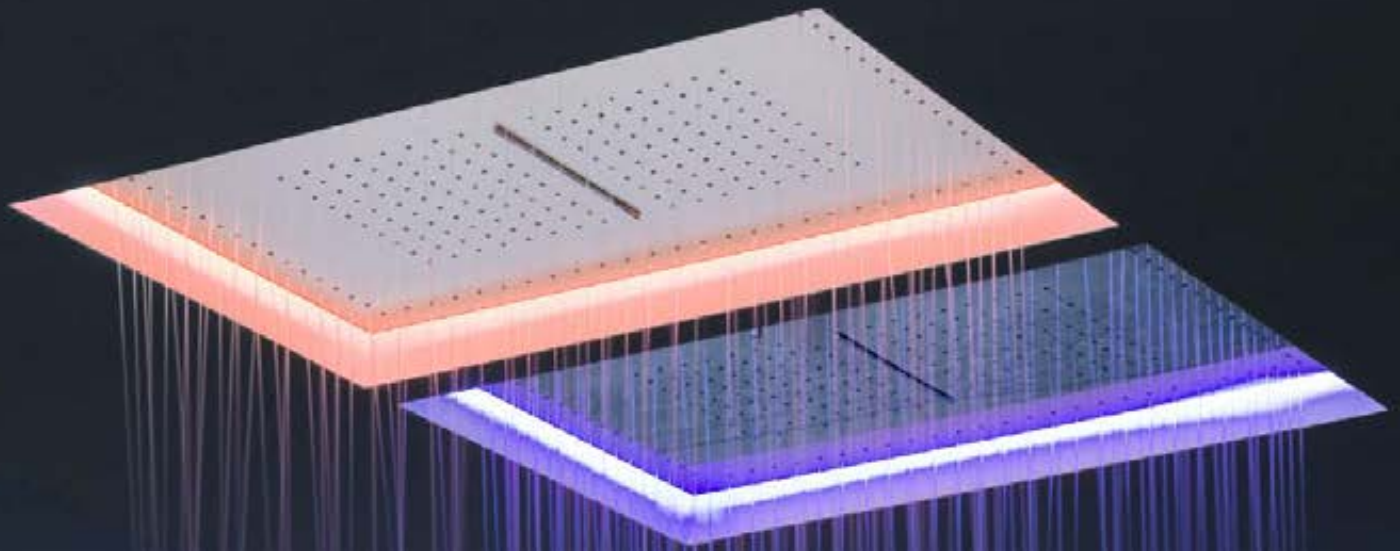

doccia perimetrale

*perimeter shower*

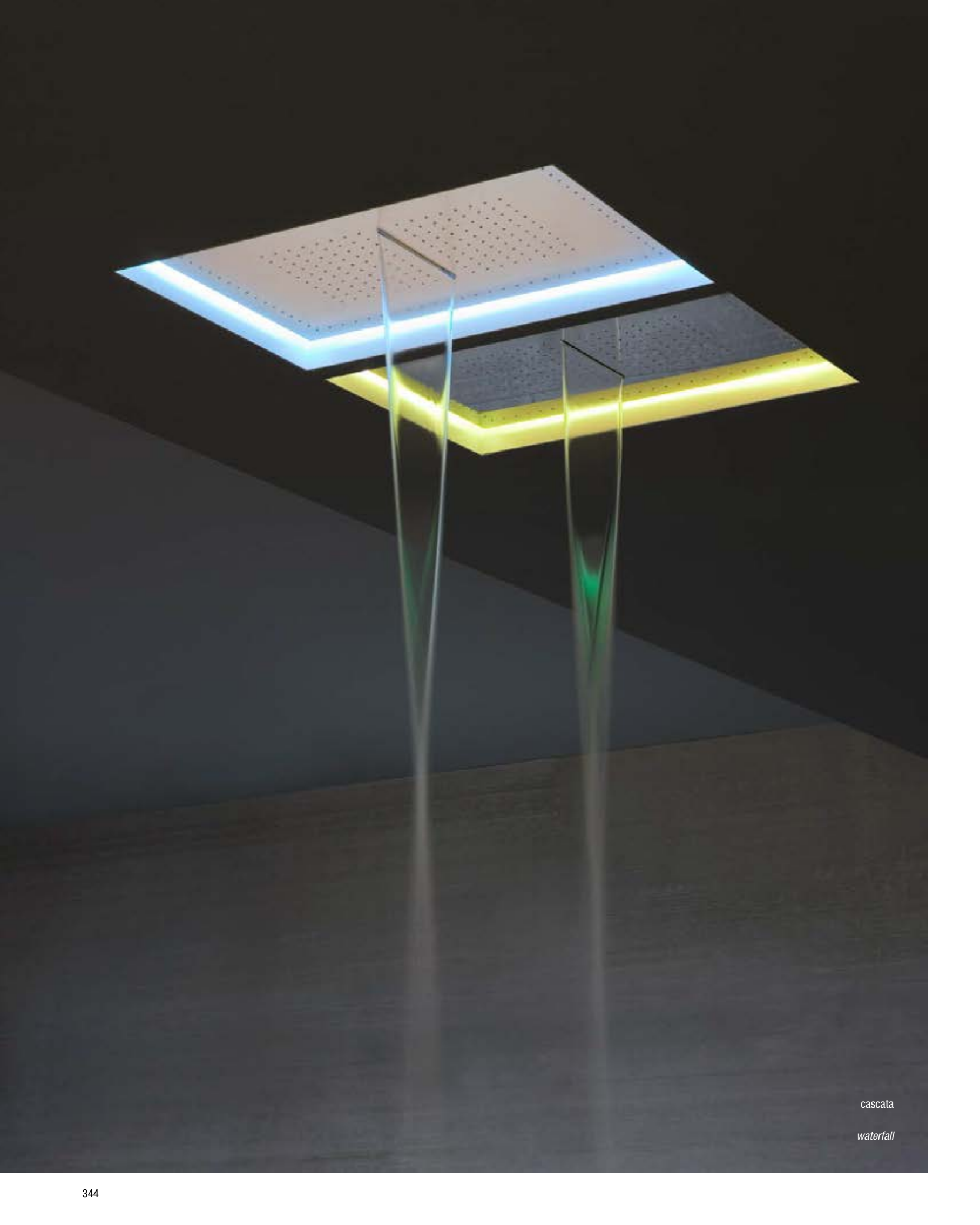

cascata

*waterfall*



doccia centrale

central shower

Tutti i soffioni con illuminazione a LED RGB sono dotati di telecomando waterproof IP66 che può essere utilizzato comodamente sotto la doccia.



All overhead showers with RGB LED lighting come with an IP66 waterproof remote control that can easily be used under the shower.

H	P	L	art.
11	52	75	METE03C

Soffione ad incasso a soffitto in acciaio AISI 304 con doccia centrale e perimetrale, cascata e possibile illuminazione a LED RGB comprensiva di telecomando waterproof.

N.B. Necessita di deviatore a tre vie.

*Ceiling encased showerhead in stainless steel AISI 304 with central and perimeter shower, waterfall and possible RGB LED lighting and waterproof remote.*

*P.S. Requires three way diverter.*

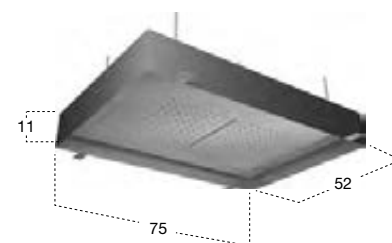



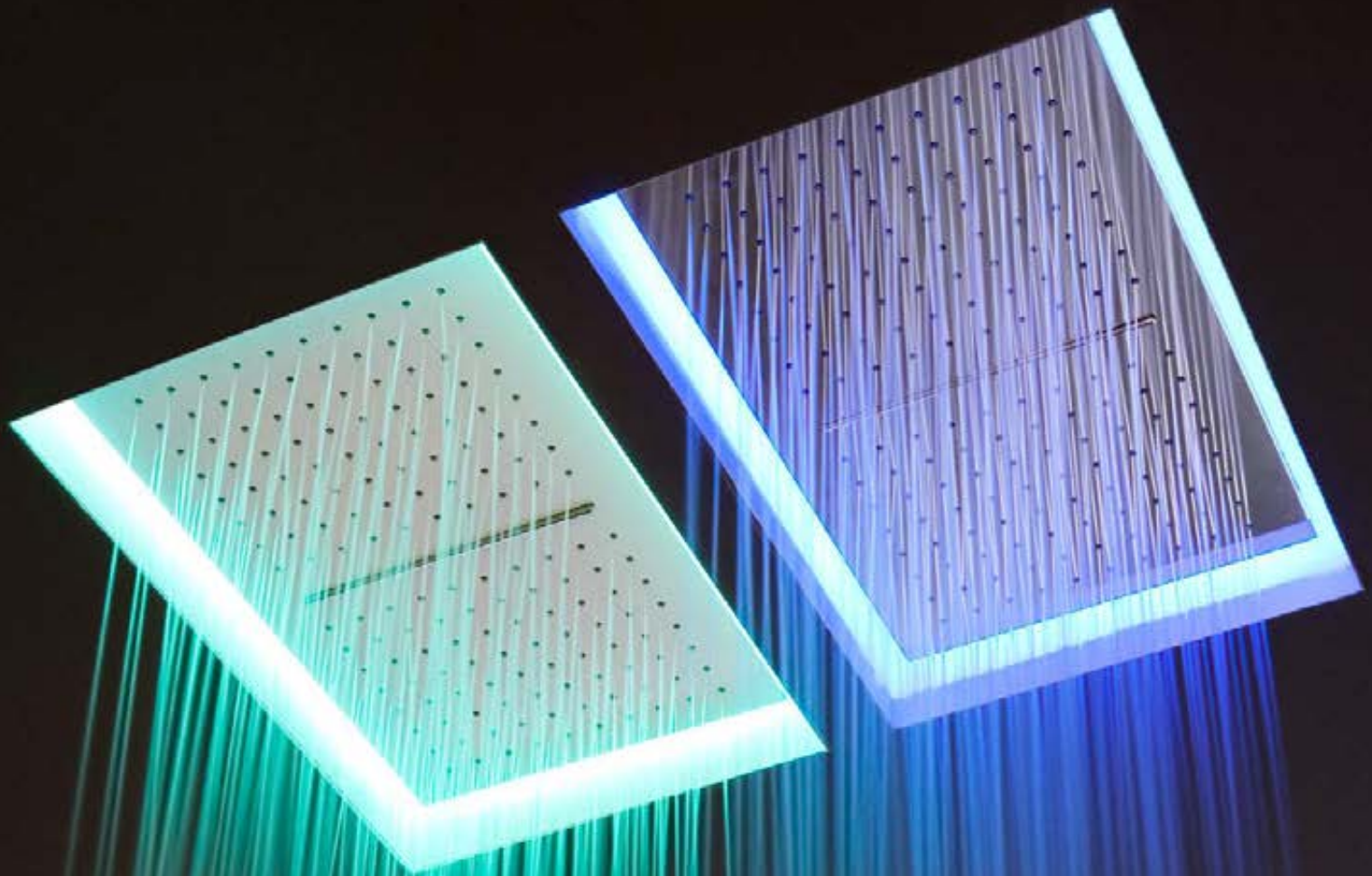

doccia centrale

*central shower*

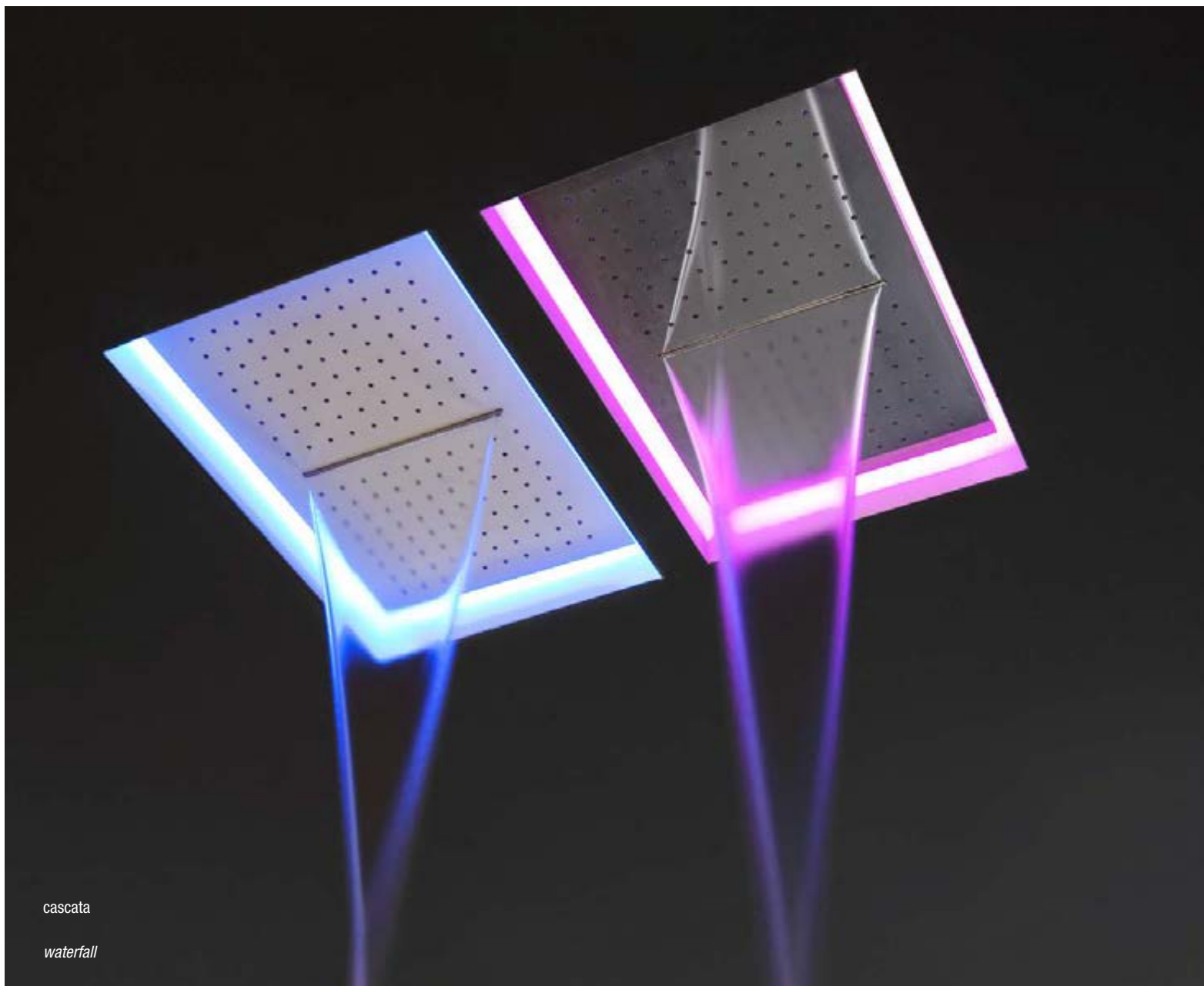

cascata

waterfall

Tutti i soffioni con illuminazione a LED RGB sono dotati di telecomando waterproof IP66 che può essere utilizzato comodamente sotto la doccia.

*All overhead showers with RGB LED lighting come with an IP66 waterproof remote control that can easily be used under the shower.*



H	P	L	art.
11	35	52	METE02C

Soffione ad incasso a soffitto in acciaio AISI 304 con doccia centrale e cascata, disponibile in diverse finiture, con possibile illuminazione a LED RGB comprensiva di telecomando waterproof.

N.B. Necessita di deviatore a due vie.

*Ceiling encased showerhead in stainless steel AISI 304 with central shower and waterfall, available in various finishes, with possible RGB LED lighting and waterproof remote.  
P.S. Requires two way diverter.*

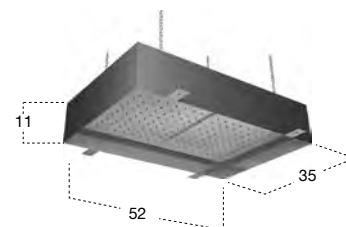

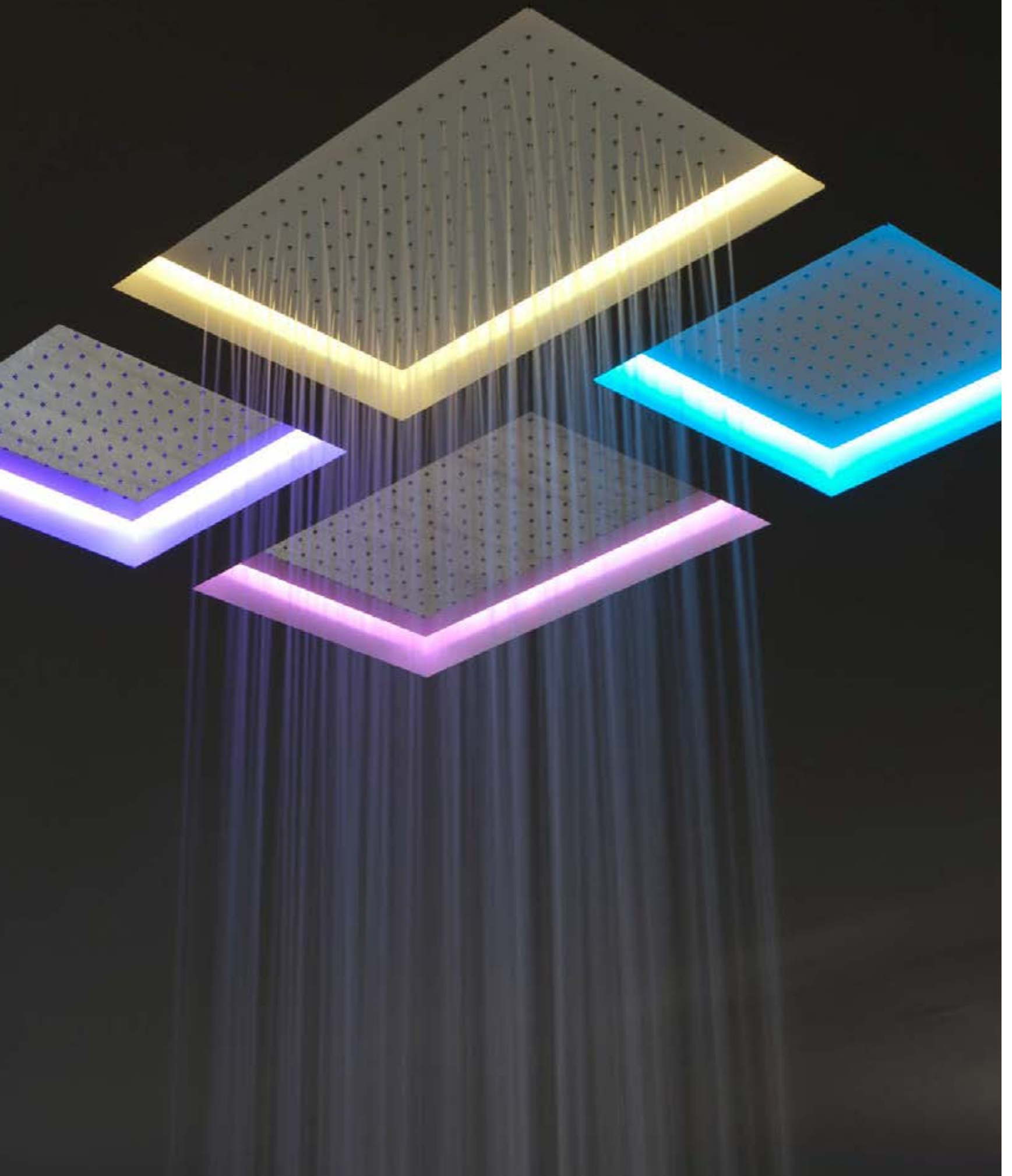



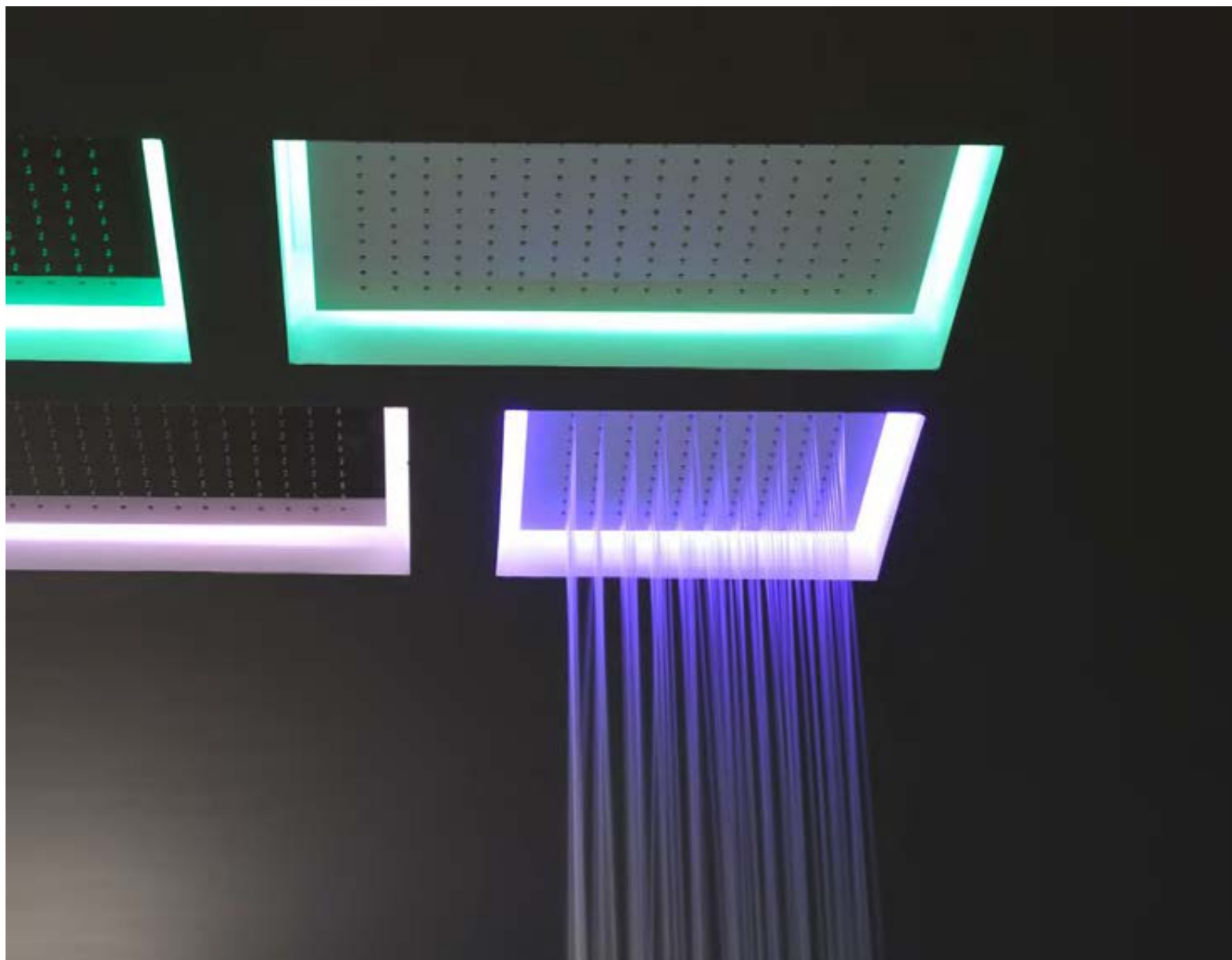

Tutti i soffioni con illuminazione a LED RGB sono dotati di telecomando waterproof IP66 che può essere utilizzato comodamente sotto la doccia.

*All overhead showers with RGB LED lighting come with an IP66 waterproof remote control that can easily be used under the shower.*



Art. METE01

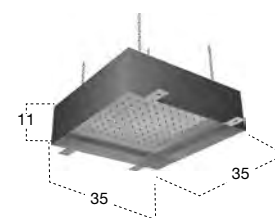

Art. METE02

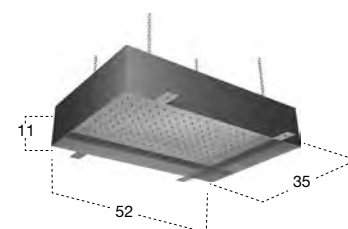

H	P	L	art.
11	35	35	METE01
11	35	52	METE02

Soffione ad incasso a soffitto in acciaio AISI 304, disponibile in diverse finiture, con possibile illuminazione a LED RGB comprensiva di telecomando waterproof.

*Ceiling encased showerhead in stainless steel AISI 304 available in various finishes, with possible RGB LED lighting and waterproof remote.*



# METEO





11



12



13



14



15



16



17



18



19



20

## FUORIMETEO design Nevio Tellatin

Modello e design registrato, brevetto depositato  
*Registered model and design, patent filed*

Fuorimeteo viene fornito bianco, la struttura esterna può essere verniciata a piacimento, dello stesso colore della parete o in contrasto con essa.

*Fuorimeteo is supplied white, the external structure can be lacquered as the client prefers, in the same color of the wall or using a different color.*





verniciato esternamente matita

*externally lacquered matita*

Tutti i soffioni con illuminazione a LED RGB sono dotati di telecomando waterproof IP66 che può essere utilizzato comodamente sotto la doccia.

*All overhead showers with RGB LED lighting come with an IP66 waterproof remote control that can easily be used under the shower.*



H	P	L	art.
13	35	52	FUORIMETE020

Soffione a soffitto con struttura esterna in acciaio AISI 304, disponibile in diverse finiture, con possibile illuminazione a LED RGB comprensiva di telecomando waterproof.

*Ceiling mounted showerhead with external frame in steel AISI 304 available in various finishes, with possible RGB LED lighting and waterproof remote.*

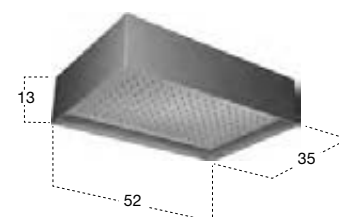



## FUORIMETEO



Tutti i soffioni con illuminazione a LED RGB sono dotati di telecomando waterproof IP66 che può essere utilizzato comodamente sotto la doccia.

*All overhead showers with RGB LED lighting come with an IP66 waterproof remote control that can easily be used under the shower.*

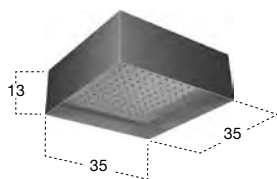

H	P	L	art.
13	35	35	FUORIMETE010

Soffione a soffitto con struttura esterna in acciaio AISI 304, disponibile in diverse finiture, con possibile illuminazione a LED RGB comprensiva di telecomando waterproof.

*Ceiling mounted showerhead with external frame in steel AISI 304 available in various finishes, with possible RGB LED lighting and waterproof remote.*



Tutti i soffioni con illuminazione a LED RGB sono dotati di telecomando waterproof IP66 che può essere utilizzato comodamente sotto la doccia.



*All overhead showers with RGB LED lighting come with an IP66 waterproof remote control that can easily be used under the shower.*

H	P	L	art.
13	35	52	FUORIMETE020C

Soffione a soffitto con doccia centrale, cascata e struttura esterna in acciaio AISI 304, disponibile in diverse finiture, con possibile illuminazione a LED RGB comprensiva di telecomando waterproof.

N.B. Necessita di deviatore a due vie.

*Ceiling mounted showerhead with central shower, waterfall and external frame in steel AISI 304, available in various finishes, with possible RGB LED lighting and waterproof remote. P.S. Requires two way diverter.*

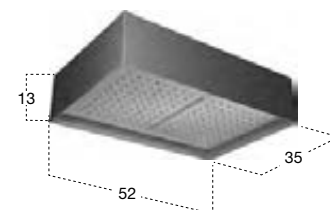

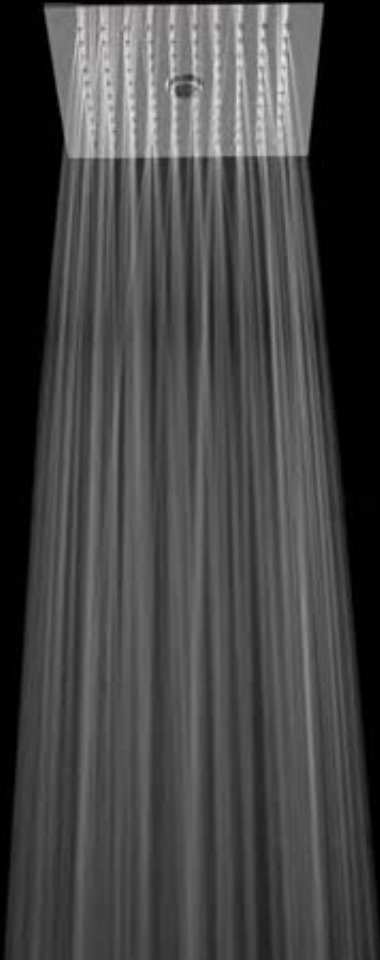

doccia + chiodo  
*shower + jet*

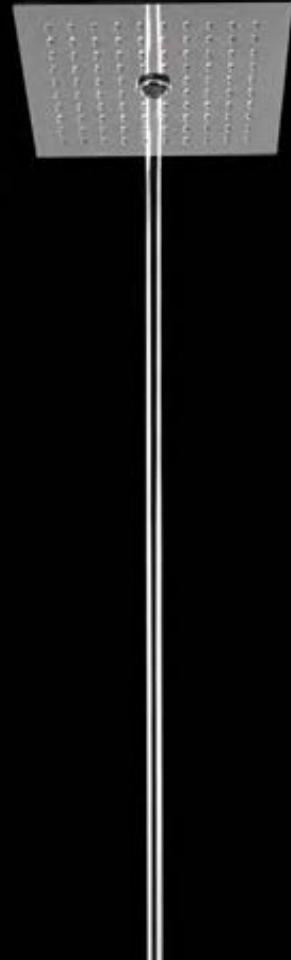

chiodo  
*jet*



doccia  
*shower*



cascata  
*waterfall*



H	P	L	art.
0,5	25	25	LMN1_A
0,5	25	25	LMN2_A
0,5	25	25	LMN3_A

**Art. LMN1\_A**

Soffione modulare ad incasso a soffitto in acciaio inox lucido AISI 304.

*Ceiling encased modular showerhead in polished stainless steel AISI 304.*

**Art. LMN2\_A**

Soffione modulare ad incasso a soffitto con getto a chiodo in acciaio inox lucido AISI 304.

N.B. Necessita di deviatore a due vie.

*Ceiling encased modular showerhead with hard center jet in polished stainless steel AISI 304.*

*P.S. Requires two way diverter.*

**Art. LMN3\_A**

Soffione modulare ad incasso a soffitto con cascata in acciaio inox lucido AISI 304.

*Ceiling encased modular showerhead with waterfall in polished stainless steel AISI 304.*

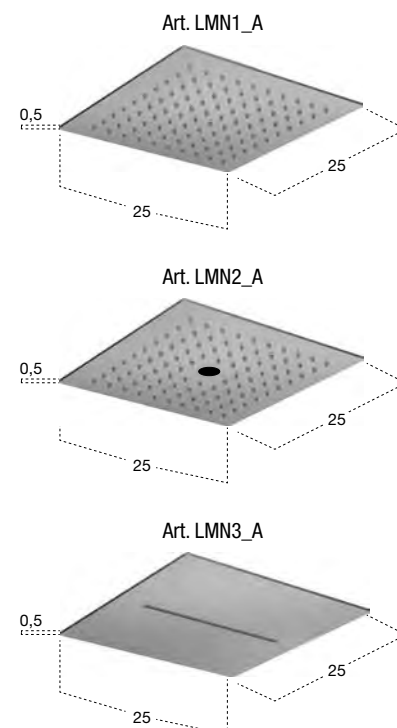





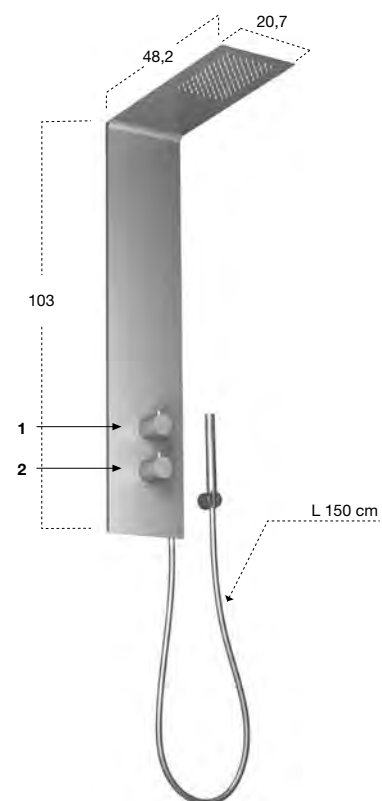

H	P	L	art.
103	48,2	20,7	VELA

Colonna doccia a parete in acciaio inox satinato AISI 304, completa di soffione, miscelatore termostatico (2), rubinetto di comando con deviatore a due vie (1) e doccia con flessibile 150 cm.

*Showerhead column in AISI 304 satin stainless steel complete with thermostatic mixer (2), command handle with 2-way diverter (1) and hand shower with hose 150 cm.*



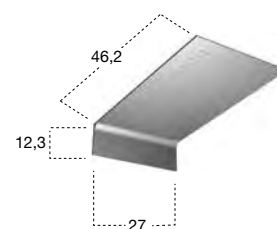

H	P	L	art.
12,3	46,2	27	MEZZAVELA

Soffione a parete in acciaio inox satinato AISI 304.

*AISI 304 satin stainless steel wall mounted showerhead.*







H	P	L	art.	
0,2	50,3	20,7	LASTRA	Acciaio Satinato / <i>Satin Stainless Steel</i>
0,2	50,3	20,7	LASTRALU	Acciaio Lucido / <i>Polished Stainless Steel</i>
0,2	50,3	20,7	BILASTRA	Acciaio Satinato / <i>Satin Stainless Steel</i>
0,2	50,3	20,7	BILASTRALU	Acciaio Lucido / <i>Polished Stainless Steel</i>

**Art. LASTRA / LASTRALU**

Soffione a parete in acciaio inox AISI 304 satinato o lucido.

*Wall mounted showerhead in satin or polished stainless steel AISI 304.*

**Art. BILASTRA / BILASTRALU**

Soffione a parete con cascata in acciaio inox AISI 304 satinato o lucido.

N.B. Necessita di deviatore a due vie.

*Wall mounted waterfall showerhead in satin or polished stainless steel AISI 304.*

*P.S. Requires two way diverter.*

Art. LASTRA / LASTRALU

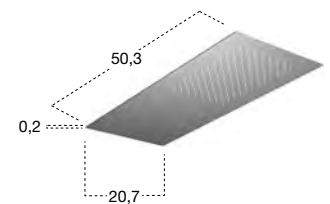

Art. BILASTRA / BILASTRALU

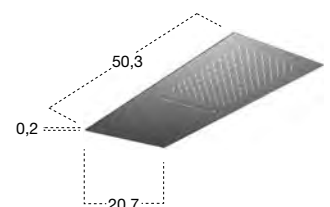





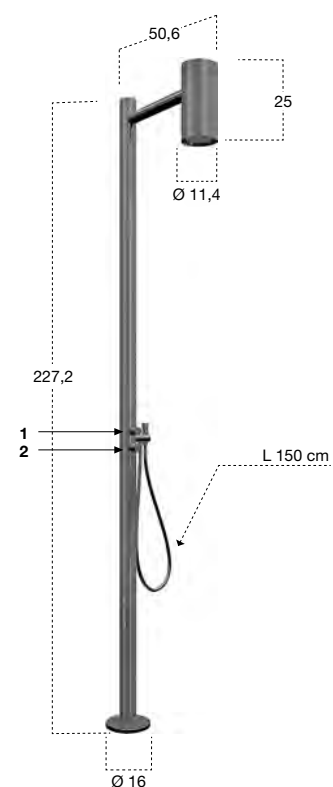

H	P	L	art.
227,2	50,6	11,4	SHAWA2

Colonna doccia da terra per interno o esterno, in acciaio inox satinato AISI 316/L, completa di corpo ad incasso, soffione, miscelatore (2), rubinetto di comando con deviatore a due vie (1) e doccetta con flessibile 150 cm.

*Freestanding shower for internal and external use, in satin stainless steel AISI 316/L complete with concealed valve, overhead shower, mixer (2), command handle with two way diverter (1) and hand shower with hose 150 cm.*





grafite  
*graphite*

RUBINETTERIA / TAPS



**MAYDAY** design GI-RA

Modello e design registrato, brevetto depositato  
*Registered model and design, patent filed*

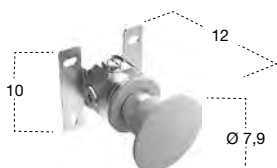

H	P	Ø	art.
10	12	7,9	MAYDAY

Miscelatore monocomando da incasso a parete, con manopola in acciaio inox satinato AISI 316/L o grafite, oppure in ottone verniciato rosso o bianco completo di corpo ad incasso.

*Single lever wall mixer with handle in satin stainless steel AISI 316/L or graphite, red or white lacquered brass complete with concealed valve.*

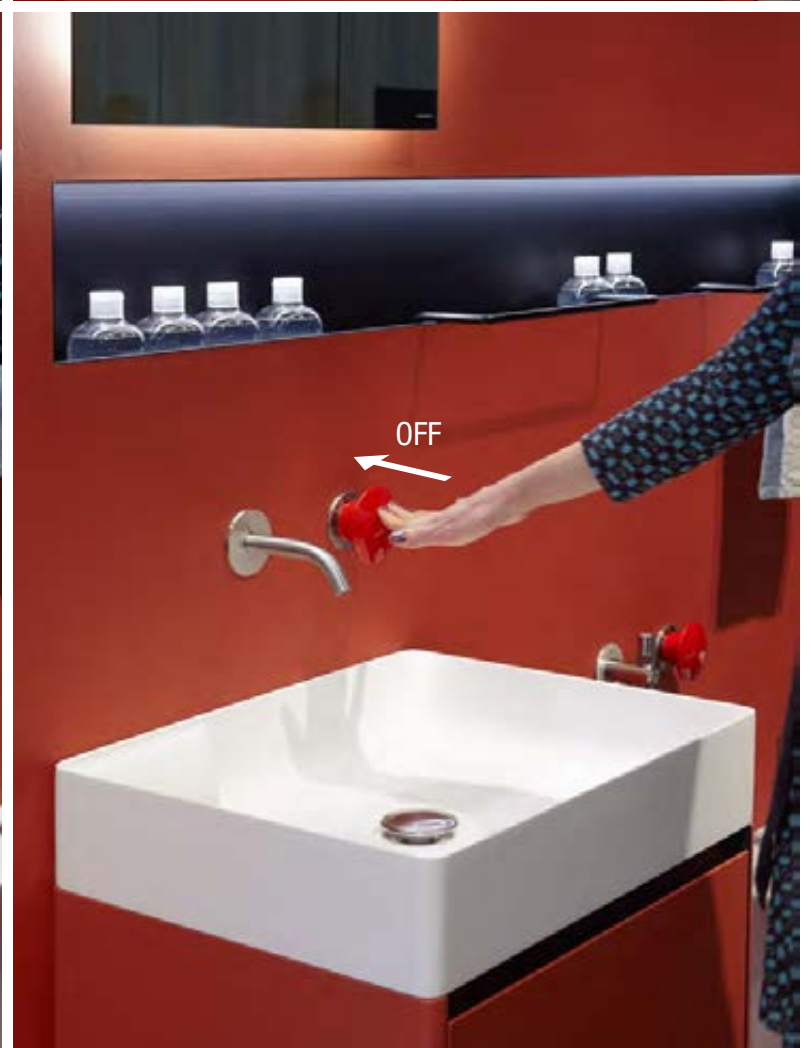







H	P	L	art.
8	6,8	6,5	VIBRO

Doccetta in acciaio inox satinato AISI 316/L, completa di supporto e presa d'acqua a parete con flessibile 150 cm.

*Satin stainless steel AISI 316/L hand shower complete with wall mounted support, water outlet and flexible hose 150 cm.*

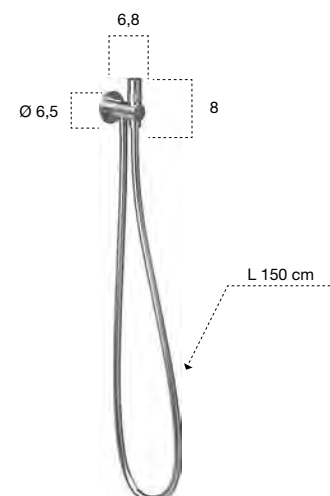

INDIGO design Nevio Tellatin

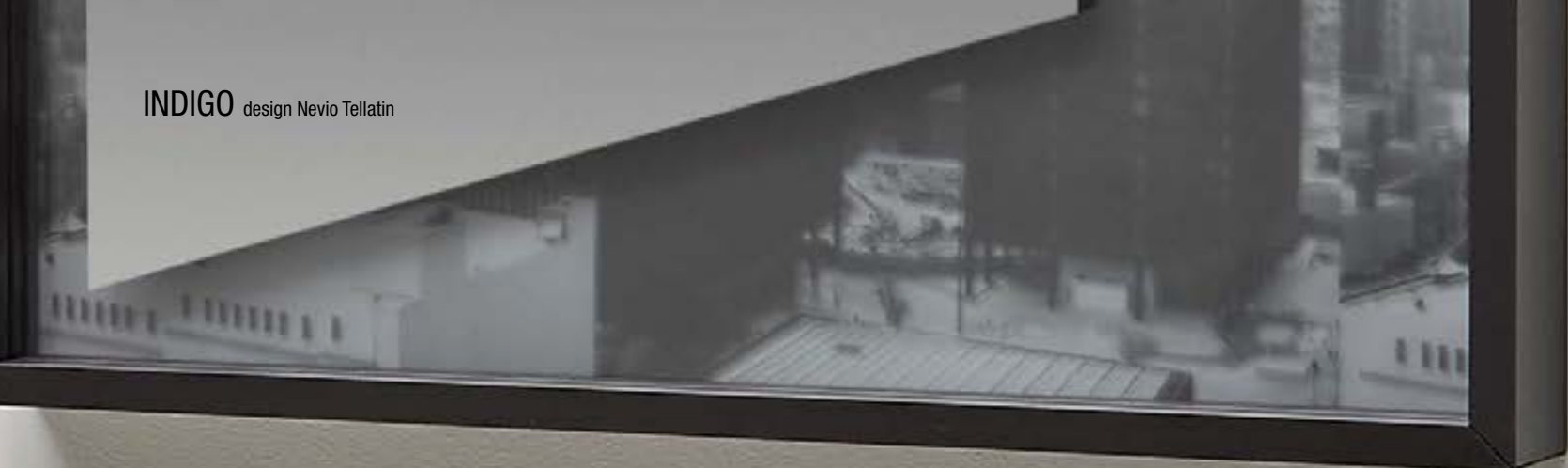

grafite

graphite



cromo lucido

*polished chrome*





grafite  
graphite



grafite

*graphite*

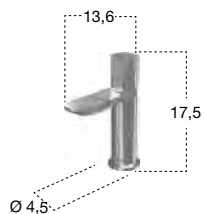

H	P	Ø	ART.	
17,5	13,6	4,5	ND400LU	Cromo Lucido / Polished Chrome
	13,6	4,5	ND400GR	Grafite / Graphite

Miscelatore monocomando per bidet.

*Single lever mixer for bidet.*

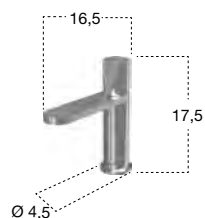

H	P	Ø	ART.	
17,5	16,5	4,5	ND301LU	Cromo Lucido / Polished Chrome
	16,5	4,5	ND301GR	Grafite / Graphite

Miscelatore monocomando da piano per lavabo.

*Single lever basin mixer for top mounting.*



H	P	Ø	ART.	
28,5	19,5	4,5	ND303LU	Cromo Lucido / Polished Chrome
	19,5	4,5	ND303GR	Grafite / Graphite

Miscelatore monocomando da piano per lavabo.

*Single lever basin mixer for top mounting*



H	P	Ø	ART.	
38,5	19,5	4,5	ND304LU	Cromo Lucido / Polished Chrome
	19,5	4,5	ND304GR	Grafite / Graphite

Miscelatore monocomando da piano per lavabo.

*Single lever basin mixer for top mounting*

ART.  
ND902IN

Corpo ad incasso per Art. ND901LU, Art. ND901GR, Art. ND902LU, Art. ND902GR, Art. ND903LU e Art. ND903GR.

Concealed valve for Art. ND901LU, Art. ND901GR, Art. ND902LU, Art. ND902GR, Art. ND903LU and Art. ND903GR.

H	P	Ø	ART.	
101	29	10	ND901LU	Cromo Lucido / Polished Chrome
	29	10	ND901GR	Grafite / Graphite
106	33,5	10	ND902LU	Cromo Lucido / Polished Chrome
	33,5	10	ND902GR	Grafite / Graphite

Miscelatore monocomando da terra per lavabo, escluso di corpo ad incasso.

Freestanding single lever sink mixer, concealed valve not included.

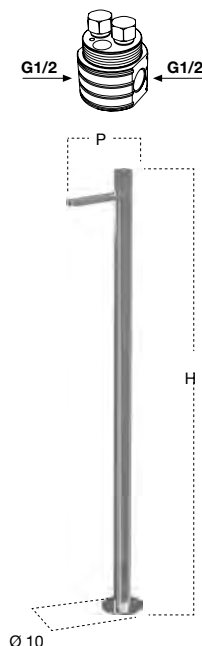

ART.  
ND201INLU Cromo lucido / Polished Chrome  
ND201INGR Grafite / Graphite

Corpo ad incasso per Art. ND200LU, Art. ND200GR, Art. ND201LU e Art. ND201GR.

Concealed valve for Art. ND200LU, Art. ND200GR, Art. ND201LU and Art. ND201GR.

H	P	L	ART.	
7	17	20	ND200LU	Cromo Lucido / Polished Chrome
	17	20	ND200GR	Grafite / Graphite
	26	20	ND201LU	Cromo Lucido / Polished Chrome
	26	20	ND201GR	Grafite / Graphite

Miscelatore monocomando a parete per lavabo, escluso di corpo ad incasso.

Single lever wall mount sink mixer, concealed valve not included.

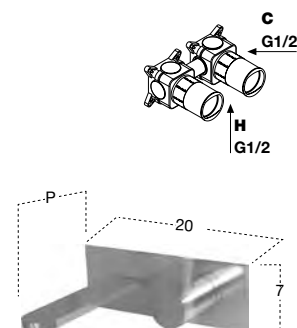

P	Ø	ART.	
20	7	ND921LU	Cromo Lucido / Polished Chrome
20	7	ND921GR	Grafite / Graphite
25	7	ND922LU	Cromo Lucido / Polished Chrome
25	7	ND922GR	Grafite / Graphite

Erogatore a parete per lavabo, completo di corpo ad incasso.

Wall mount sink spout complete with concealed valve.

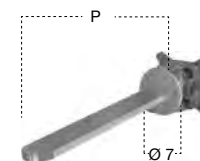



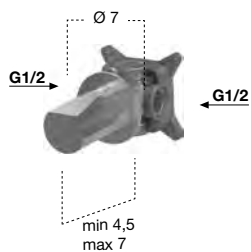

H	P	Ø	ART.	
6,8	4,5/7	7	ND605LU	Cromo Lucido / Polished Chrome
	4,5/7	7	ND605GR	Grafite / Graphite

Rubinetto da arresto acqua calda e fredda, completo di corpo ad incasso.

*Hot and cold water stop valve complete with concealed valve.*

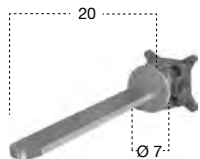

P	Ø	ART.	
20	7	ND704LU	Cromo Lucido / Polished Chrome
20	7	ND704GR	Grafite / Graphite

Erogatore a parete per vasca completo di corpo ad incasso.

*Bathtub wall spout complete with concealed valve.*

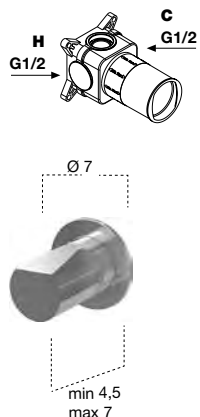

ART.	
ND601INLU	Cromo Lucido / Polished Chrome
ND601INGR	Grafite / Graphite

Corpo ad incasso per Art. ND601LU, Art. ND601GR.

*Concealed valve for Art. ND601LU, Art. ND601GR.*

P	Ø	ART.	
4,5/7	7	ND601LU	Cromo Lucido / Polished Chrome
	7	ND601GR	Grafite / Graphite

Miscelatore monocomando da incasso a parete, escluso di corpo ad incasso.

*Encased wall mixer, concealed valve not included.*

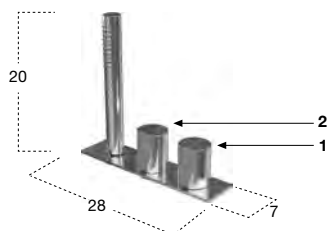

H	P	L	ART.	
20	7	31,5	ND702LU	Cromo Lucido / Polished Chrome
	7	31,5	ND702GR	Grafite / Graphite

Gruppo bordo vasca completo di miscelatore acqua calda e fredda (1), miscelatore per doccia (2) e doccia con flessibile 150 cm a scomparsa.

*Bath rim set complete with hot and cold water mixer (1), mixer for hand shower (2) and hand shower with hidden hose 150 cm.*

ART.  
ND902IN

Corpo ad incasso per Art. ND901LU, Art. ND901GR, Art. ND902LU, Art. ND902GR, Art. ND903LU e Art. ND903GR.

Concealed valve for Art. ND901LU, Art. ND901GR, Art. ND902LU, Art. ND902GR, Art. ND903LU and Art. ND903GR.

H	P	Ø	ART.	
87,7	28,5	10	ND903LU	Cromo Lucido / Polished Chrome
	28,5	10	ND903GR	Grafite / Graphite

Colonna da terra per vasca, completa di miscelatore per erogazione (1), miscelatore per doccia (2) e doccia con flessibile 150 cm, escluso di corpo ad incasso.

Freestanding bath mixer, complete with mixer for spout (1), hand shower mixer (2) and hand shower with flexible hose 150 cm, concealed valve not included.

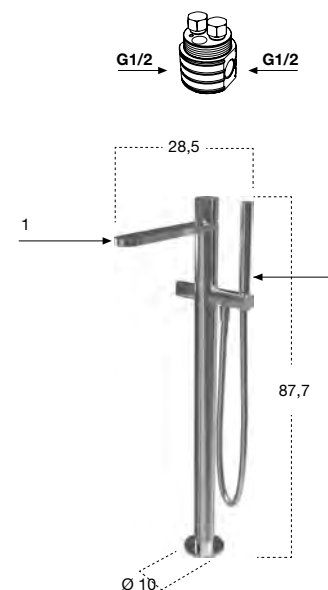

ART.  
ND602INLU Cromo Lucido / Polished Chrome  
ND602INGR Grafite / Graphite

Corpo ad incasso per Art. ND602LU e Art. ND602GR.

Concealed valve for Art. ND602LU e Art. ND602GR.

P	Ø	ART.	
4,5/7	7	ND602LU	Cromo Lucido / Polished Chrome
	7	ND602GR	Grafite / Graphite

Deviatore incasso a due vie, escluso di corpo ad incasso.

Encased two way diverter, concealed valve not included.

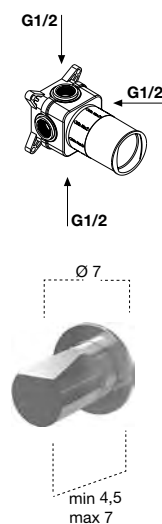

ART.  
ND603INLU Cromo Lucido / Polished Chrome  
ND603INGR Grafite / Graphite

Corpo ad incasso per Art. ND603LU e Art. ND603GR.

Concealed valve for Art. ND603LU e Art. ND603GR.

P	Ø	ART.	
4,5/7	7	ND603LU	Cromo Lucido / Polished Chrome
	7	ND603GR	Grafite / Graphite

Deviatore incasso a due vie, escluso di corpo ad incasso.

Encased two way diverter, concealed valve not included.

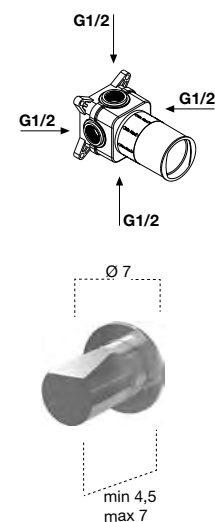

**AYATI** design Massimo Broglio

Modello e design registrato, brevetto depositato  
*Registered model and design, patent filed*







AYATI





AYATI









Programma rubinetteria di estrema versatilità, con possibilità di realizzare canne su misura, interamente realizzato in acciaio inox AISI 304, finitura satinata o lucida.  
*Highly versatile taps series, with the ability to create custom spouts, made entirely of stainless steel AISI 304, satin or polished finish.*

H	P	Ø	art.	
16	15,5	5	AY400SA	Acciaio Satinato / <i>Satin Stainless Steel</i>
16	15,5	5	AY400LU	Acciaio Lucido / <i>Polished Stainless Steel</i>

Miscelatore monocomando per bidet.

*Single lever mixer for bidet.*



H	P	Ø	art.	
16	15,5	5	AY301SA	Acciaio Satinato / <i>Satin Stainless Steel</i>
16	15,5	5	AY301LU	Acciaio Lucido / <i>Polished Stainless Steel</i>

Miscelatore monocomando da piano per lavabo.

*Single lever basin mixer for top mounting.*



H	P	Ø	art.	
22	15,5	5	AY302SA	Acciaio Satinato / <i>Satin Stainless Steel</i>
22	15,5	5	AY302LU	Acciaio Lucido / <i>Polished Stainless Steel</i>

Miscelatore monocomando da piano per lavabo.

*Single lever basin mixer for top mounting.*



H	P	Ø	art.	
35	27,3	5	AY303SA	Acciaio Satinato / <i>Satin Stainless Steel</i>
35	27,3	5	AY303LU	Acciaio Lucido / <i>Polished Stainless Steel</i>

Miscelatore monocomando da piano per lavabo.

*Single lever basin mixer for top mounting.*





H	P	Ø	art.	
45	27,3	5	AY304SA	Acciaio Satinato / <i>Satin Stainless Steel</i>
45	27,3	5	AY304LU	Acciaio Lucido / <i>Polished Stainless Steel</i>

Miscelatore monocomando da piano per lavabo.

*Single lever basin mixer for top mounting.*

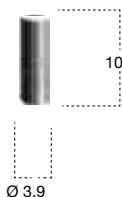

H	Ø	art.	
10	3,9	AY304PRSA	Acciaio Satinato / <i>Satin Stainless Steel</i>
10	3,9	AY304PRLU	Acciaio Lucido / <i>Polished Stainless Steel</i>

Prolunga per Art. AY304SA e Art. AY304LU.

*Extension for Art. AY304SA and Art. AY304LU.*

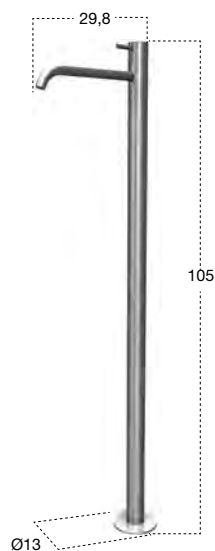
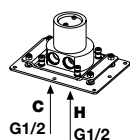

			art.	
			AY902IN	

Corpo ad incasso per art. AY902SA, art. AY902LU, art. AY903SA e art. AY903LU.

*Concealed valve for art. AY902SA, art. AY902LU, art. AY903SA and art. AY903LU.*

H	P	Ø	art.	
105	29,8	13	AY902SA	Acciaio Satinato / <i>Satin Stainless Steel</i>
105	29,8	13	AY902LU	Acciaio Lucido / <i>Polished Stainless Steel</i>

Miscelatore monocomando da terra per lavabo, escluso di corpo ad incasso.

*Freestanding single lever sink mixer, concealed valve not included.*

art.

AY201INSA Acciaio Satinato / *Satin Stainless Steel*

AY201INLU Acciaio Lucido / *Polished Stainless Steel*

Corpo ad incasso per art. AY202SA, art. AY202LU, art. AY200SA, art. AY200LU, art. AY201SA e art. AY201LU.

*Concealed valve for art. AY202SA, art. AY202LU, art. AY200SA, art. AY200LU, art. AY201SA and art. AY201LU.*

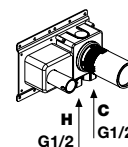

H	P	L	art.	
7,3	12,8	17,5	AY202SA	Acciaio Satinato / <i>Satin Stainless Steel</i>
7,3	12,8	17,5	AY202LU	Acciaio Lucido / <i>Polished Stainless Steel</i>
7,3	19,8	17,5	AY200SA	Acciaio Satinato / <i>Satin Stainless Steel</i>
7,3	19,8	17,5	AY200LU	Acciaio Lucido / <i>Polished Stainless Steel</i>
7,3	25,8	17,5	AY201SA	Acciaio Satinato / <i>Satin Stainless Steel</i>
7,3	25,8	17,5	AY201LU	Acciaio Lucido / <i>Polished Stainless Steel</i>

Miscelatore monocomando a parete per lavabo, escluso di corpo ad incasso.

*Single lever wall mount sink mixer, concealed valve not included.*

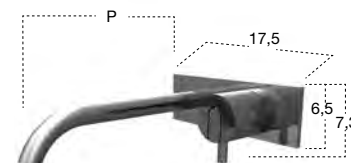

art.

AY921IN

Corpo ad incasso per art. AY920SA, art. AY920LU, art. AY921SA, art. AY921LU, art. AY922SA e art. AY922LU.

*Concealed valve for art. AY920SA, art. AY920LU, art. AY921SA, art. AY921LU art. AY922SA and art. AY922LU.*

H	P	Ø	art.	
7,3	12,8	6,5	AY920SA	Acciaio Satinato / <i>Satin Stainless Steel</i>
7,3	12,8	6,5	AY920LU	Acciaio Lucido / <i>Polished Stainless Steel</i>
7,3	19,8	6,5	AY921SA	Acciaio Satinato / <i>Satin Stainless Steel</i>
7,3	19,8	6,5	AY921LU	Acciaio Lucido / <i>Polished Stainless Steel</i>
7,3	25,8	6,5	AY922SA	Acciaio Satinato / <i>Satin Stainless Steel</i>
7,3	25,8	6,5	AY922LU	Acciaio Lucido / <i>Polished Stainless Steel</i>

Erogatore a parete per lavabo, escluso di corpo a incasso.

*Wall mount sink spout, concealed valve not included.*

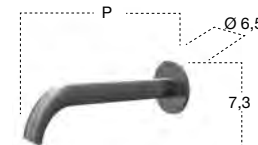
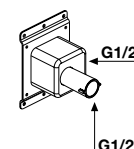

art.

AY600INSA Acciaio Satinato / *Satin Stainless Steel*

AY600INLU Acciaio Lucido / *Polished Stainless Steel*

Corpo ad incasso per art. AY600SA e art. AY600LU.

*Concealed valve for art. AY600SA and art. AY600LU.*

H	P	Ø	art.	
6,8	4,5/7	6,5	AY600SA	Acciaio Satinato / <i>Satin Stainless Steel</i>
6,8	4,5/7	6,5	AY600LU	Acciaio Lucido / <i>Polished Stainless Steel</i>

Miscelatore monocomando per lavabo da incasso a parete, escluso di corpo a incasso.

*Single lever sink mixer for wall encasing, concealed valve not included.*

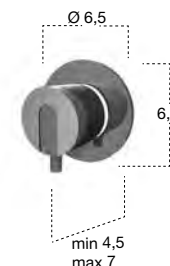
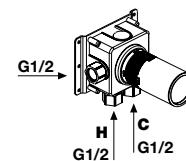



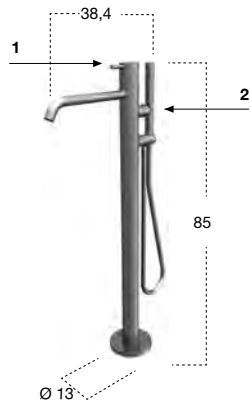
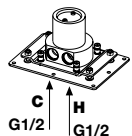

art.

AY902IN

Corpo ad incasso per art. AY902SA, art. AY902LU, art. AY903SA e art. AY903LU.

Concealed valve for art. AY902SA, art. AY902LU, art. AY903SA and art. AY903LU.

H	P	Ø	art.	
85	38,4	13	AY903SA	Acciaio Satinato / Satin Stainless Steel
85	38,4	13	AY903LU	Acciaio Lucido / Polished Stainless Steel

Colonna da terra per vasca, completa di miscelatore per erogazione (1), miscelatore per doccia (2) e doccia con flessibile 150 cm, escluso di corpo ad incasso.

Freestanding bath mixer, complete with mixer for spout (1), hand shower mixer (2) and hand shower with flexible hose 150 cm, concealed valve not included.

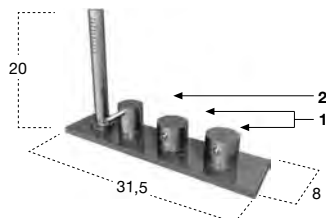

H P L art.

20	8	31,5	AY702SA	Acciaio Satinato / Satin Stainless Steel
20	8	31,5	AY702LU	Acciaio Lucido / Polished Stainless Steel

Gruppo bordo vasca completo di rubinetti di comando acqua calda e fredda (1), miscelatore per doccia (2) e doccia con flessibile 150 cm a scomparsa.

Bath rim set complete with hot and cold water handles (1), shower mixer (2) and hand shower with hidden hose 150 cm.

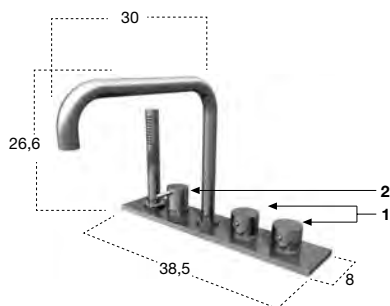

H P L art.

26,6	30	38,5	AY701SA	Acciaio Satinato / Satin Stainless Steel
26,6	30	38,5	AY701LU	Acciaio Lucido / Polished Stainless Steel

Gruppo bordo vasca completo di erogatore, rubinetti di comando acqua calda e fredda (1), miscelatore per doccia (2) e doccia con flessibile 150 cm a scomparsa.

Bath rim set complete with spout, hot and cold water handles (1), shower mixer (2) and hand shower with hidden hose 150 cm.

art.

AY601INSA Acciaio Satinato / *Satin Stainless Steel*

AY601INLU Acciaio Lucido / *Polished Stainless Steel*

Corpo ad incasso per art. AY601SA e art. AY601LU.

*Concealed valve for art. AY601SA and art. AY601LU.*

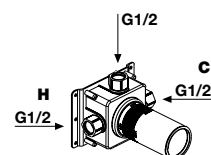

H	P	Ø	art.	
6,8	4,5/7	6,5	AY601SA	Acciaio Satinato / <i>Satin Stainless Steel</i>
6,8	4,5/7	6,5	AY601LU	Acciaio Lucido / <i>Polished Stainless Steel</i>

Miscelatore monocomando per doccia da incasso a parete, escluso di corpo a incasso.

*Single lever shower mixer for wall encasing, concealed valve not included.*



art.

AY604INSA Acciaio Satinato / *Satin Stainless Steel*

AY604INLU Acciaio Lucido / *Polished Stainless Steel*

Corpo ad incasso per art. AY604SA e art. AY604LU.

*Concealed valve for art. AY604SA and art. AY604LU.*

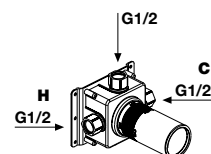

H	P	Ø	art.	
8	6,1/8,6	6,5	AY604SA	Acciaio Satinato / <i>Satin Stainless Steel</i>
8	6,1/8,6	6,5	AY604LU	Acciaio Lucido / <i>Polished Stainless Steel</i>

Miscelatore termostatico coassiale con apertura e chiusura acqua, escluso di corpo a incasso.

*Coaxial thermostatic mixer with command handle, concealed valve not included.*

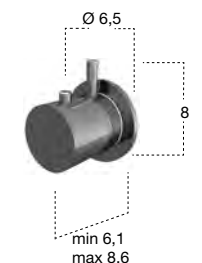

art.

AY602INSA Acciaio Satinato / *Satin Stainless Steel*

AY602INLU Acciaio Lucido / *Polished Stainless Steel*

Corpo ad incasso per art. AY602SA e art. AY602LU.

*Concealed valve for art. AY602SA and art. AY602LU.*

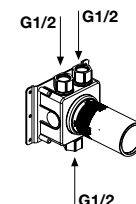

P	Ø	art.	
4,5/7	6,5	AY602SA	Acciaio Satinato / <i>Satin Stainless Steel</i>
4,5/7	6,5	AY602LU	Acciaio Lucido / <i>Polished Stainless Steel</i>

Deviatore incasso a due vie, escluso di corpo ad incasso.

*Encased two way diverter, concealed valve not included.*



art.

AY603INSA Acciaio Satinato / *Satin Stainless Steel*

AY603INLU Acciaio Lucido / *Polished Stainless Steel*

Corpo ad incasso per art. AY603SA e art. AY603LU.

*Concealed valve for art. AY603SA and art. AY603LU.*

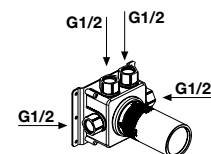

P	Ø	art.	
4,5/7	6,5	AY603SA	Acciaio Satinato / <i>Satin Stainless Steel</i>
4,5/7	6,5	AY603LU	Acciaio Lucido / <i>Polished Stainless Steel</i>

Deviatore incasso a tre vie, escluso di corpo a incasso.

*Encased three way diverter, concealed valve not included.*



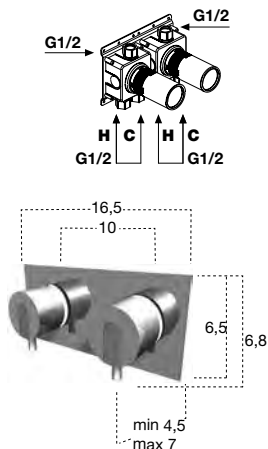

art.

AY650INSA Acciaio Satinato / *Satin Stainless Steel*

AY650INLU Acciaio Lucido / *Polished Stainless Steel*

Corpo ad incasso per art. AY650PSA, art. AY650PLU, art. AY650RSA e art. AY650RLU.

*Concealed valve for art. AY650PSA, art. AY650PLU, art. AY650RSA and art. AY650RLU.*

H	P	L	art.	
6,8	4,5/7	16,5	AY650PSA	Acciaio Satinato / <i>Satin Stainless Steel</i>
6,8	4,5/7	16,5	AY650PLU	Acciaio Lucido / <i>Polished Stainless Steel</i>

Composizione doccia (2 miscelatori), escluso di corpo a incasso.

*Shower set (2 mixers), concealed valve not included.*

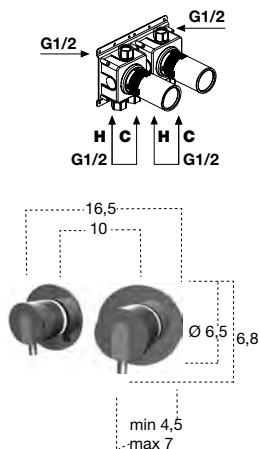

art.

AY650INSA Acciaio Satinato / *Satin Stainless Steel*

AY650INLU Acciaio Lucido / *Polished Stainless Steel*

Corpo ad incasso per art. AY650PSA, art. AY650PLU, art. AY650RSA e art. AY650RLU.

*Concealed valve for art. AY650PSA, art. AY650PLU, art. AY650RSA and art. AY650RLU.*

H	P	L	art.	
6,8	4,5/7	16,5	AY650RSA	Acciaio Satinato / <i>Satin Stainless Steel</i>
6,8	4,5/7	16,5	AY650RLU	Acciaio Lucido / <i>Polished Stainless Steel</i>

Composizione doccia (2 miscelatori), escluso di corpo a incasso.

*Shower set (2 mixers), concealed valve not included.*

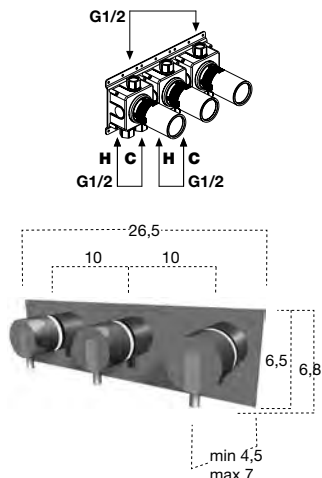

art.

AY651INSA Acciaio Satinato / *Satin Stainless Steel*

AY651INLU Acciaio Lucido / *Polished Stainless Steel*

Corpo ad incasso per art. AY651PSA, art. AY651PLU, art. AY651RSA e art. AY651RLU.

*Concealed valve for art. AY651PSA, art. AY651PLU, art. AY651RSA and art. AY651RLU.*

H	P	L	art.	
6,8	4,5/7	26,5	AY651PSA	Acciaio Satinato / <i>Satin Stainless Steel</i>
6,8	4,5/7	26,5	AY651PLU	Acciaio Lucido / <i>Polished Stainless Steel</i>

Composizione doccia (3 miscelatori), escluso di corpo a incasso.

*Shower set (3 mixers), concealed valve not included.*

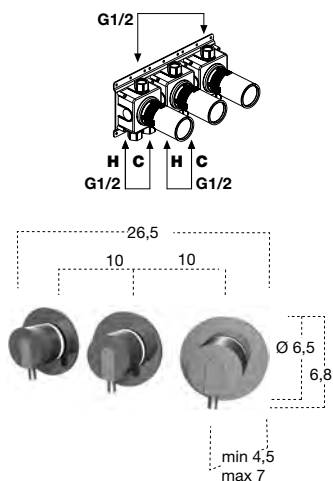

art.

AY651INSA Acciaio Satinato / *Satin Stainless Steel*

AY651INLU Acciaio Lucido / *Polished Stainless Steel*

Corpo ad incasso per art. AY651PSA, art. AY651PLU, art. AY651RSA e art. AY651RLU.

*Concealed valve for art. AY651PSA, art. AY651PLU, art. AY651RSA and art. AY651RLU.*

H	P	L	art.	
6,8	4,5/7	26,5	AY651RSA	Acciaio Satinato / <i>Satin Stainless Steel</i>
6,8	4,5/7	26,5	AY651RLU	Acciaio Lucido / <i>Polished Stainless Steel</i>

Composizione doccia (3 miscelatori), escluso di corpo ad incasso.

*Shower set (3 mixers), concealed valve not included.*

art.

AY652INSA Acciaio Satinato / *Satin Stainless Steel*

AY652INLU Acciaio Lucido / *Polished Stainless Steel*

Corpo ad incasso per art. AY652PSA, art. AY652PLU, art. AY652RSA e art. AY652RLU.

Concealed valve for art. AY652PSA, art. AY652PLU, art. AY652RSA and art. AY652RLU.

H	P	L	art.	
6,8	4,5/7	16,5	AY652PSA	Acciaio Satinato / <i>Satin Stainless Steel</i>
6,8	4,5/7	16,5	AY652PLU	Acciaio Lucido / <i>Polished Stainless Steel</i>

Composizione doccia 1 miscelatore (1) e 1 deviatore 2 vie (2), escluso di corpo a incasso.

Shower set 1 mixer (1), 1 two way diverter (2), concealed valve not included.

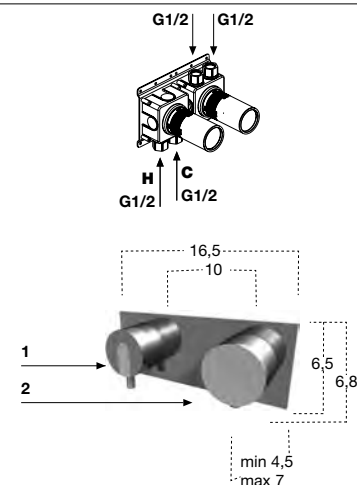

art.

AY652INSA Acciaio Satinato / *Satin Stainless Steel*

AY652INLU Acciaio Lucido / *Polished Stainless Steel*

Corpo ad incasso per art. AY652PSA, art. AY652PLU, art. AY652RSA e art. AY652RLU.

Concealed valve for art. AY652PSA, art. AY652PLU, art. AY652RSA and art. AY652RLU.

H	P	L	art.	
6,8	4,5/7	16,5	AY652RSA	Acciaio Satinato / <i>Satin Stainless Steel</i>
6,8	4,5/7	16,5	AY652RLU	Acciaio Lucido / <i>Polished Stainless Steel</i>

Composizione doccia 1 miscelatore (1) e 1 deviatore 2 vie (2), escluso di corpo a incasso.

Shower set 1 mixer (1), 1 two way diverter (2), concealed valve not included.

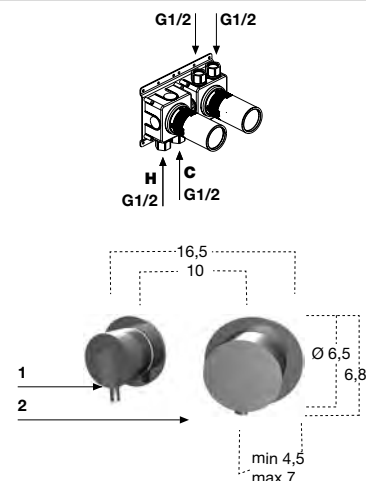

art.

AY653INSA Acciaio Satinato / *Satin Stainless Steel*

AY653INLU Acciaio Lucido / *Polished Stainless Steel*

Corpo ad incasso per art. AY653PSA, art. AY653PLU, art. AY653RSA e art. AY653RLU.

Concealed valve for art. AY653PSA, art. AY653PLU, art. AY653RSA and art. AY653RLU.

H	P	L	art.	
6,8	4,5/7	16,5	AY653PSA	Acciaio Satinato / <i>Satin Stainless Steel</i>
6,8	4,5/7	16,5	AY653PLU	Acciaio Lucido / <i>Polished Stainless Steel</i>

Composizione doccia 1 miscelatore (1) e 1 deviatore 3 vie (2), escluso di corpo a incasso.

Shower set 1 mixer (1), 1 three way diverter (2), concealed valve not included.

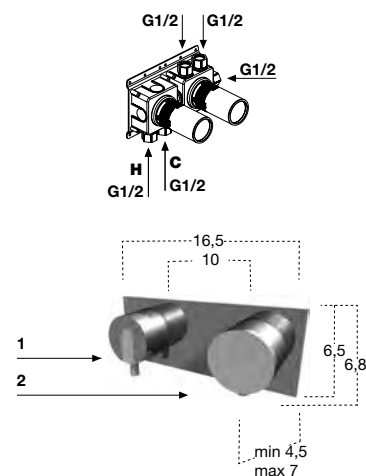

art.

AY653INSA Acciaio Satinato / *Satin Stainless Steel*

AY653INLU Acciaio Lucido / *Polished Stainless Steel*

Corpo ad incasso per art. AY653PSA, art. AY653PLU, art. AY653RSA e art. AY653RLU.

Concealed valve for art. AY653PSA, art. AY653PLU, art. AY653RSA and art. AY653RLU.

H	P	L	art.	
6,8	4,5/7	16,5	AY653RSA	Acciaio Satinato / <i>Satin Stainless Steel</i>
6,8	4,5/7	16,5	AY653RLU	Acciaio Lucido / <i>Polished Stainless Steel</i>

Composizione doccia 1 miscelatore (1) e 1 deviatore 3 vie (2), escluso di corpo a incasso.

Shower set 1 mixer (1), 1 three way diverter (2), concealed valve not included.

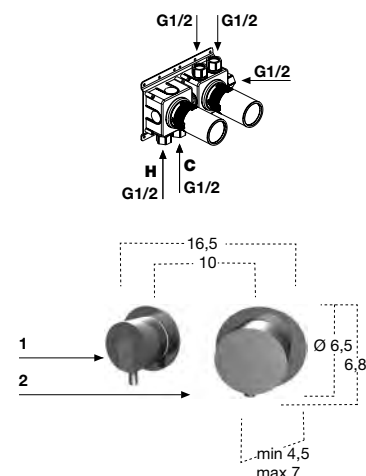



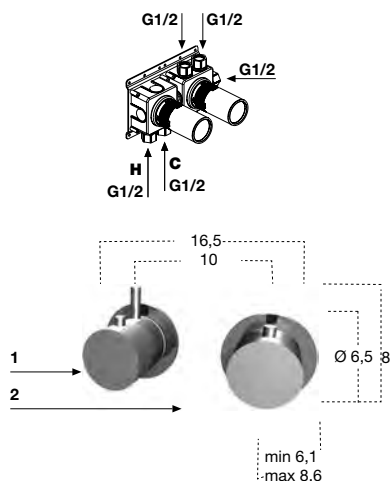
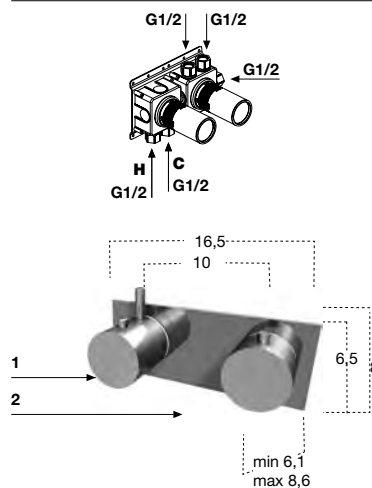
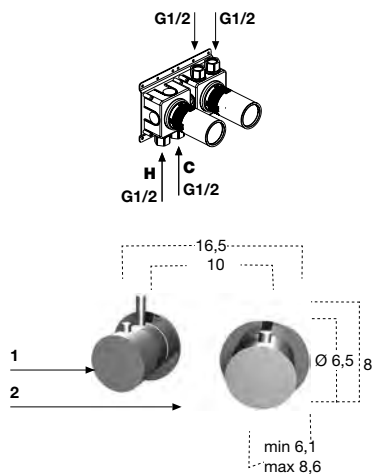
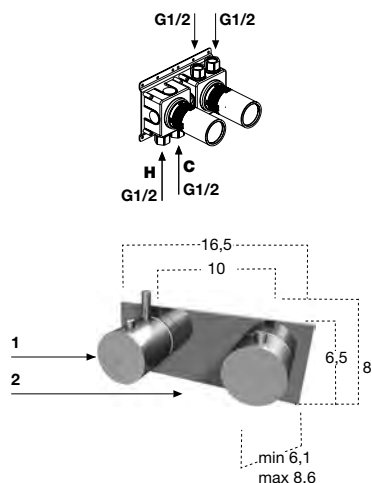

art.

AY654INSA Acciaio Satinato / *Satin Stainless Steel*

AY654INLU Acciaio Lucido / *Polished Stainless Steel*

Corpo ad incasso per art. AY654PSA, art. AY654PLU, art. AY654RSA e art. AY654RLU.

*Concealed valve for art. AY654PSA, art. AY654PLU, art. AY654RSA and art. AY654RLU.*

H	P	L	art.	
8	6,1/8,6	16,5	AY654PSA	Acciaio Satinato / <i>Satin Stainless Steel</i>
8	6,1/8,6	16,5	AY654PLU	Acciaio Lucido / <i>Polished Stainless Steel</i>

Composizione doccia 1 termostatico coassiale con apertura e chiusura acqua (1) e 1 deviatore 2 vie (2), escluso di corpo a incasso.

*Shower set 1 coaxial thermostatic with command handle (1), 1 two way diverter (2), concealed valve not included.*

art.

AY654INSA Acciaio Satinato / *Satin Stainless Steel*

AY654INLU Acciaio Lucido / *Polished Stainless Steel*

Corpo ad incasso per art. AY654PSA, art. AY654PLU, art. AY654RSA e art. AY654RLU.

*Concealed valve for art. AY654PSA, art. AY654PLU, art. AY654RSA and art. AY654RLU.*

H	P	L	art.	
8	6,1/8,6	16,5	AY654RSA	Acciaio Satinato / <i>Satin Stainless Steel</i>
8	6,1/8,6	16,5	AY654RLU	Acciaio Lucido / <i>Polished Stainless Steel</i>

Composizione doccia 1 termostatico coassiale con apertura e chiusura acqua (1) e 1 deviatore 2 vie (2), escluso di corpo a incasso.

*Shower set 1 coaxial thermostatic with command handle (1), 1 two way diverter (2), concealed valve not included.*

art.

AY655INSA Acciaio Satinato / *Satin Stainless Steel*

AY655INLU Acciaio Lucido / *Polished Stainless Steel*

Corpo ad incasso per art. AY655PSA, art. AY655PLU, art. AY655RSA e art. AY655RLU.

*Concealed valve for art. AY655PSA, art. AY655PLU, art. AY655RSA and art. AY655RLU.*

H	P	L	art.	
8	6,1/8,6	16,5	AY655PSA	Acciaio Satinato / <i>Satin Stainless Steel</i>
8	6,1/8,6	16,5	AY655PLU	Acciaio Lucido / <i>Polished Stainless Steel</i>

Composizione doccia 1 termostatico coassiale con apertura e chiusura acqua (1) e 1 deviatore 3 vie (2), escluso di corpo a incasso.

*Shower set 1 coaxial thermostatic with command handle (1), 1 three way diverter (2), concealed valve not included.*

art.

AY655INSA Acciaio Satinato / *Satin Stainless Steel*

AY655INLU Acciaio Lucido / *Polished Stainless Steel*

Corpo ad incasso per art. AY655PSA, art. AY655PLU, art. AY655RSA e art. AY655RLU.

*Concealed valve for art. AY655PSA, art. AY655PLU, art. AY655RSA and art. AY655RLU.*

H	P	L	art.	
8	6,1/8,6	16,5	AY655RSA	Acciaio Satinato / <i>Satin Stainless Steel</i>
8	6,1/8,6	16,5	AY655RLU	Acciaio Lucido / <i>Polished Stainless Steel</i>

Composizione doccia 1 termostatico coassiale con apertura e chiusura acqua (1) e 1 deviatore 3 vie (2), escluso di corpo a incasso.

*Shower set 1 coaxial thermostatic with command handle (1), 1 three way diverter (2), concealed valve not included.*

H	P	L	art.	
23,5	8,7	6,5	AY150SA	Acciaio Satinato / <i>Satin Stainless Steel</i>
23,5	8,7	6,5	AY150LU	Acciaio Lucido / <i>Polished Stainless Steel</i>

Doccetta completa di supporto e presa d'acqua a parete con flessibile 150 cm.

*Hand shower with hose cm 150, wall outlet and holder.*

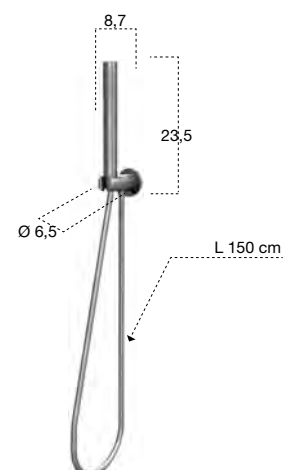

H	P	L	art.	
105,6	7,6	10	ASTA151SA	Acciaio Satinato / <i>Satin Stainless Steel</i>
105,6	7,6	10	ASTA151LU	Cromo Lucido / <i>Polished Chrome</i>

Doccetta completa di asta scorrevole e presa acqua separata a parete con flessibile 150 cm.

*Hand shower complete with bar and separate wall mount water intake with flexible hose 150 cm.*

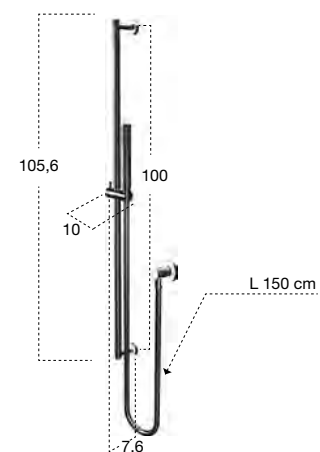





oro rosa

rose gold



BIKAPPA



cromo nero spazzolato

*black brushed chrome*





BIKAPPA





BIKAPPA









# BIKAPPA

Realizzato in ottone con finitura CROMO LUCIDO, ORO ROSA e CROMO NERO SPAZZOLATO.  
 Produced in brass with a POLISHED CHROME FINISH, ROSE GOLD and BLACK BRUSHED CHROME.

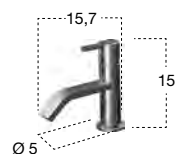

H	P	Ø	art.
15	15,7	5	BK400N

Monocomando da piano per lavabo o bidet.

*Single lever sink mixer for sink or bidet.*



H	P	Ø	art.
22	24	5	BK300N

Monocomando da piano per lavabo.

*Single lever sink mixer.*



H	P	Ø	art.
35	24	5	BK904N

Monocomando da piano per lavabo.

*Single lever sink mixer.*

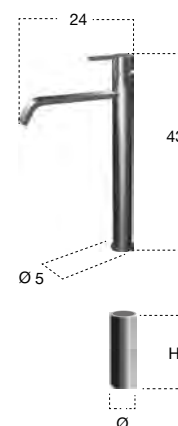

H	P	Ø	art.
43	24	5	BK905N

Monocomando da piano per lavabo.

*Single lever sink mixer.*

H	Ø	art.
6	3,5	BK400PR
12	4,2	BK905PR

Prolunga H 6 cm per art. BK400N e H 12 cm per art. BK905N.  
 Extension 6 cm H for art. BK904N and 12 cm H for art. BK905N.

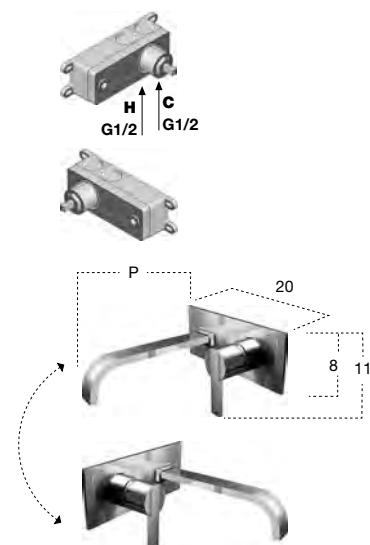

art.
BK201I

Corpo ad incasso reversibile per Art. BK200N e Art. BK201N.  
 Reversible concealed valve for Art. BK200N and Art. BK201N.

H	P	L	art.
11	20	20	BK200N
11	25	20	BK201N

Monocomando reversibile a parete per lavabo, escluso di corpo ad incasso.  
 Reversible single lever wall mount sink mixer, concealed valve not included.

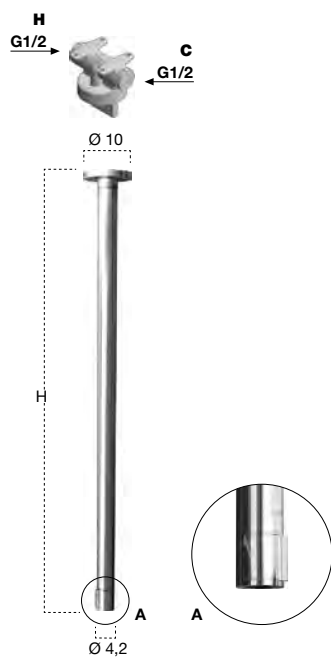

art.
BK906I

Corpo ad incasso per Art. BK906N, Art. BK907N, Art. BK908N e Art. BK909N.  
*Concealed valve for Art. BK906N, Art. BK907N, Art. BK908N and Art. BK909N.*

H	Ø	art.
120	10	BK906N
130	10	BK907N
140	10	BK908N
150	10	BK909N

Colonna da soffitto per lavabo con sistema di comando progressivo, escluso di corpo a incasso.

*Ceiling mounted basin mixer with progressive mixer control, concealed valve not included.*



art.
BK903IN

Corpo ad incasso per Art. BK902N e Art. BK903N.  
*Concealed valve for Art. BK902N and Art. BK903N.*

H	P	Ø	art.
110	29,5	10	BK902N

Monocomando da terra per lavabo, escluso di corpo a incasso.

*Freestanding single lever sink mixer, concealed valve not included.*

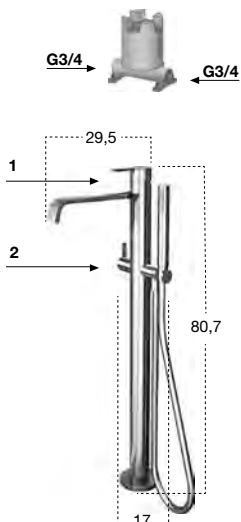

art.
BK903IN

Corpo ad incasso per Art. BK902N e Art. BK903N.  
*Concealed valve for Art. BK902N and Art. BK903N.*

H	P	L	art.
80,7	29,5	17	BK903N

Colonna da terra per vasca, completa di miscelatore per erogatore (1), miscelatore per doccia (2), doccia con flessibile 150 cm, escluso di corpo a incasso.

*Freestanding bath mixer complete with single lever for spout (1) shower mixer (2) hand shower with hose 150 cm, concealed valve not included.*

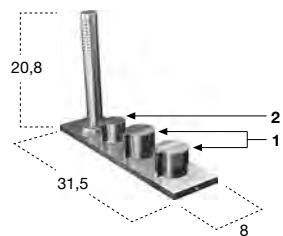

H	P	L	art.
20,8	8	31,5	BK702

Gruppo bordo vasca completo di rubinetti di comando acqua calda e fredda (1), miscelatore per doccia (2) e doccia con flessibile 150 cm a scomparsa.

*Bath rim set complete with hot and cold water handles (1), shower mixer (2) and hand shower with hidden hose 150 cm.*

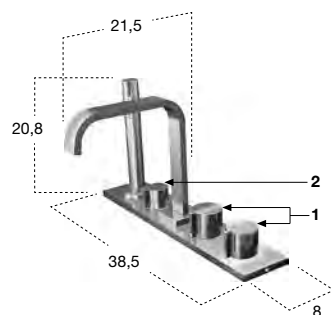

H	P	L	art.
20,8	21,5	38,5	BK701

Gruppo bordo vasca completo di erogatore, rubinetti di comando acqua calda e fredda (1), miscelatore per doccia (2) e doccia con flessibile 150 cm a scomparsa.

*Bath rim set complete with spout, hot and cold water handles (1), shower mixer (2) and hand shower with hidden hose 150 cm.*

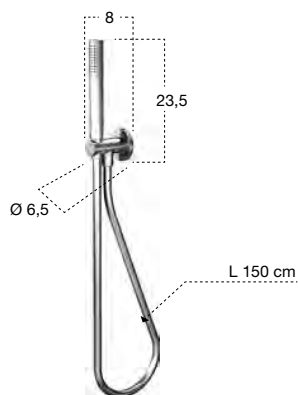

H	P	L	art.
23,5	8	6,5	BK150

Doccetta completa di supporto e presa d'acqua a parete con flessibile 150 cm.

*Hand shower with hose cm 150, wall outlet and holder.*

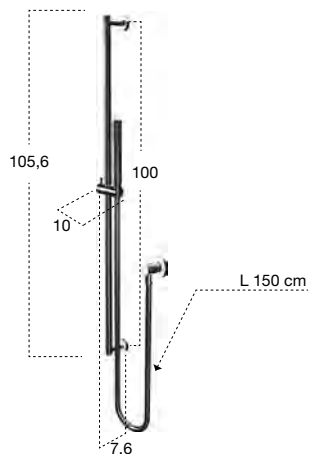

H	P	L	art.
105,6	7,6	10	ASTA151LU Cromo Lucido / Polished Chrome

Doccetta completa di asta scorrevole e presa acqua separata a parete con flessibile 150 cm.

*Hand shower complete with bar and separate wall mount water intake with flexible hose 150 cm.*

art.

BK601I

Corpo ad incasso per Art. BK601 e Art. BK616.

*Concealed valve for Art. BK601 and Art. BK616.*

H	P	L	art.
16	8	10	BK616

Monocomando da incasso parete, escluso di corpo ad incasso.

*Encased mixer, concealed valve not included.*

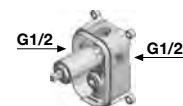

art.

BK601I

Corpo ad incasso per Art. BK601 e Art. BK616.

*Concealed valve for Art. BK601 and Art. BK616.*

H	P	L	art.
16	8	10	BK601

Monocomando da incasso parete con deviatore, escluso di corpo ad incasso.

*Encased mixer with diverter, concealed valve not included.*

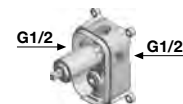

art.

BK602I

Corpo ad incasso per Art. BK602.

*Concealed valve for Art. BK602.*

H	P	L	art.
24	5	13	BK602

Gruppo doccia da incasso parete con miscelatore termostatico (2) e rubinetto di comando con deviatore a due vie (1), escluso di corpo ad incasso.

*Encased mixer with thermostat (2) command handle with two-way diverter (1), concealed valve not included.*

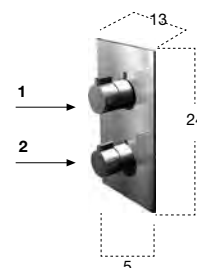
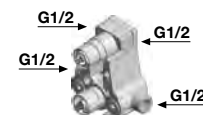

art.

BK603I

Corpo ad incasso per Art. BK603.

*Concealed valve for Art. BK603.*

H	P	L	art.
24	5	13	BK603

Gruppo doccia da incasso parete con miscelatore termostatico (2), rubinetto di comando con deviatore a tre vie (1), escluso di corpo ad incasso.

*Encased mixer with thermostat (2) command handle and three-way diverter (1), concealed valve not included.*

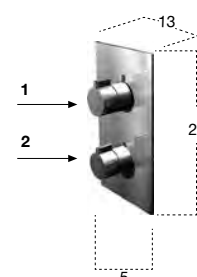
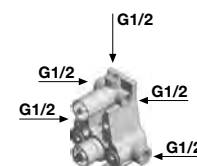









Verniciabile esternamente in tutti i colori del nostro campionario  
*Can be externally lacquered in all colors of our collection*











H	P	L	art.
120	7	45	BITL120A
150	7	45	BITL150A
180	7	45	BITL180A

Termoarredo in alluminio versione ad acqua, Brown o colorato gofrato come da nostra cartella colori laccati.

*Aluminium designer radiator, water version, Brown or lacquered embossed as per our colour chart.*

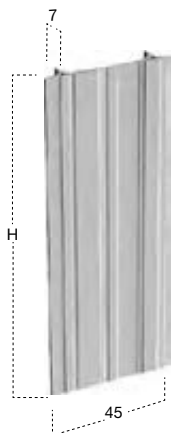

art.

BIT\_TERM0

Gruppo valvola termostattizzabile e detentore 50 mm a squadra, con kit raccordi intercambiabili per tubo in rame ø 10-12-14 e multistrato ø 10/14 - 12/16, in finitura cromo lucido o acciaio satinato.

*Thermostatable radiator valve and angle lockshield 50 mm with interchangeable fittings kit for copper tube ø 10-12-14 and plywood ø 10/14 - 12/16, in polished chrome finish or satin steel finish.*



H	P	L	art.
120	7	45	BITL120E
150	7	45	BITL150E
180	7	45	BITL180E

Termoarredo in alluminio versione elettrica, completo di cronotermostato, Brown o colorato gofrato come da nostra cartella colori laccati.

*Aluminium designer radiator, electric version, complete with programmable thermostat, Brown or lacquered embossed as per our colour chart.*

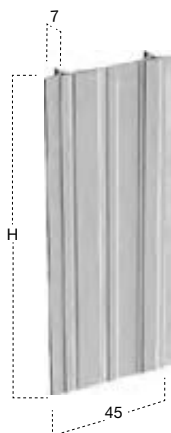

art.

BIT\_REMO

Gruppo valvola remoto termostattizzabile ad incasso con attacchi 1/2" F per impianto bitubo, per termoarredo versione ad acqua, in finitura cromo lucido.

*Remote thermostatable radiator valve to be encased with 1/2" F connectors for two-pipe system, for water version radiators in polished chrome finish.*

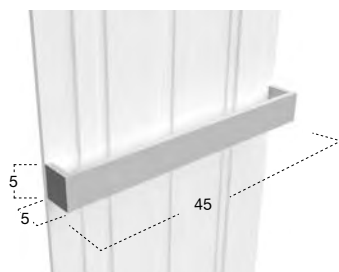

H	P	L	art.
5	5	45	BITBARRA

Porta salviette per termoarredo in acciaio inox satinato AISI 304, Brown o colorato gofrato come da nostra cartella colori laccati.

*Towel holder for radiator in satin stainless steel AISI 304, Brown or lacquered embossed as per our colour chart.*



art.

BIT\_TT

Testa termostatica con sensore a liquido per art. BIT\_TERM0 e art. BIT\_REMO per termoarredo versione ad acqua in finitura cromo lucido o acciaio satinato.

*Thermostatic head with liquid sensor for art. BIT\_TERM0 and art. BIT\_REMO for water version radiators in polished chrome finish or satin steel finish.*

H	L	art.
10	2,5	GANCIOLIGHT

Appendi abiti per termoarredo in acciaio inox satinato AISI 304, Brown o colorato gofrato come da nostra cartella colori laccati.

*Clothes hook for radiators in satin stainless steel AISI 304, Brown or lacquered embossed as per our colour chart.*

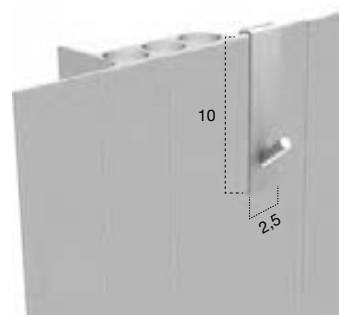





H	P	L	art.
23	6,4	90	BITL190E
23	6,4	120	BITL1120E

Termoarredo orizzontale in alluminio versione elettrica, completo di portasalviette e cronotermostato, Brown o colorato gofrato come da nostra cartella colori laccati.

*Horizontal aluminium designer radiator, electric version, complete with towel holder and programmable thermostat, Brown or lacquered embossed as per our colour chart.*

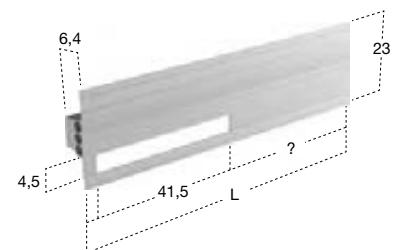



## BIT

I termoarredi nella versione bianco opaco (RAL 9010) possono essere personalizzati con l'utilizzo di vernici quali:

- smalto al solvente satinato, antigraffio e anticorrosivo.
- smalto ad acqua antigraffio.

I termoarredi nella versione colorato goffrato sono verniciati come da nostra cartella colori mobili.

*Designer radiators in matt white finishing (RAL 9010) can be customized using paintings like:*

- *satin solvent-based lacquer, anti-scratch and anticorrosive.*
- *anti-scratch water-based lacquer.*

*Designer radiators in embossed lacquered version can be painted as per our furniture colour chart.*



art.

BIT\_REMO

Gruppo valvola remoto termostattizzabile ad incasso con attacchi 1/2" F per impianto bitubo, per termoarredo versione ad acqua, in finitura cromo lucido.

*Remote thermostatic radiator valve to be encased with 1/2" F connectors for two-pipe system, for water version radiators in polished chrome finish.*



art.

BIT\_TT

Testa termostatica con sensore a liquido per art. BIT\_TERM0 e art. BIT\_REMO per termoarredo versione ad acqua in finitura cromo lucido o acciaio satinato.

*Thermostatic head with liquid sensor for art. BIT\_TERM0 and art. BIT\_REMO for water version radiators in polished chrome finish or satin steel finish.*

Misure standard.

Standard measurements



H	P	L	art.
60	8,2	45	BIT60A
90	8,2	45	BIT90A
120	8,2	45	BIT120A
150	8,2	45	BIT150A
180	8,2	45	BIT180A

Termoarredo in alluminio versione ad acqua, bianco opaco RAL 9010 o colorato gofrato come da nostra cartella colori laccati.

*Aluminium designer radiator, water version, matt white RAL 9010 or lacquered embossed as per our colour chart.*



H	P	L	art.
45	8,2	45	BIT45E
60	8,2	45	BIT60E
90	8,2	45	BIT90E
120	8,2	45	BIT120E
150	8,2	45	BIT150E
180	8,2	45	BIT180E

Termoarredo in alluminio versione elettrica, bianco opaco RAL 9010 o colorato gofrato come da nostra cartella colori laccati.

*Aluminium designer radiator, electric version, matt white RAL 9010 or lacquered embossed as per our colour chart.*



H	P	L	art.
60	8,2	45	BIT60AE
90	8,2	45	BIT90AE
120	8,2	45	BIT120AE
150	8,2	45	BIT150AE
180	8,2	45	BIT180AE

Termoarredo in alluminio versione mista acqua/elettrica, bianco opaco RAL 9010 o colorato gofrato come da nostra cartella colori laccati.

*Aluminium designer radiator, combined water/electric version, matt white RAL 9010 or lacquered embossed as per our colour chart.*

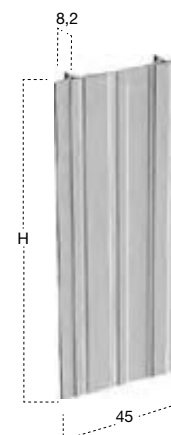

A misura.

Made to measure



H	P	L	art.
61/149	8,2	45	BIT1A
151/200	8,2	45	BIT2A
201/300	8,2	45	BIT3A

Termoarredo in alluminio versione ad acqua con altezza H a misura, bianco opaco RAL 9010 o colorato gofrato come da nostra cartella colori laccati.

*Aluminium designer radiator, water version, with custom height H, matt white RAL 9010 or lacquered embossed as per our colour chart.*

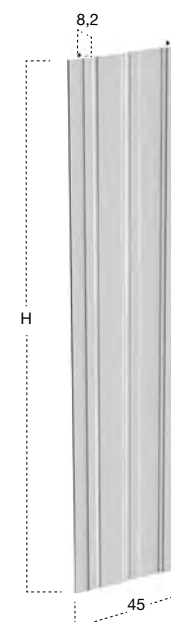





## BITBARRA design Brian Sironi

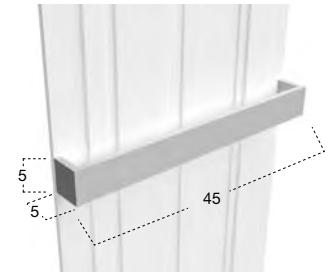

H	P	L	art.
5	5	45	BITBARRA

Porta salviette per termoarredo in acciaio inox satinato AISI 304, bianco opaco RAL 9010 o colorato goffrato come da nostra cartella colori laccati.

*Towel holder for radiator in satin stainless steel AISI 304, matt white RAL 9010 or lacquered embossed as per our colour chart.*

Possibile posizionamento per porta salviette Art. BITBARRA.

*Possible position of towel holder Art. BITBARRA.*

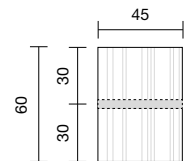
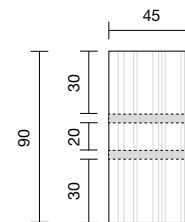
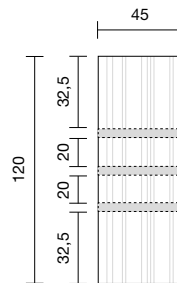
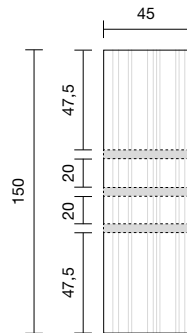
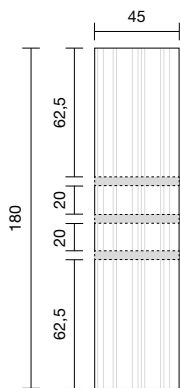

## BITGANCIO design Brian Sironi

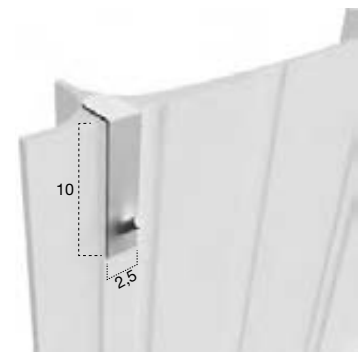

H	L	art.
10	2,5	BITGANCIO

Appendi abiti per termoarredo in acciaio inox satinato AISI 304, bianco opaco RAL 9010 o colorato goffrato come da nostra cartella colori laccati.

*Clothes hook for radiators in satin stainless steel AISI 304, matt white RAL 9010 or lacquered embossed as per our colour chart.*

COLLAGE314A  
L 54 H 75 P 5,4

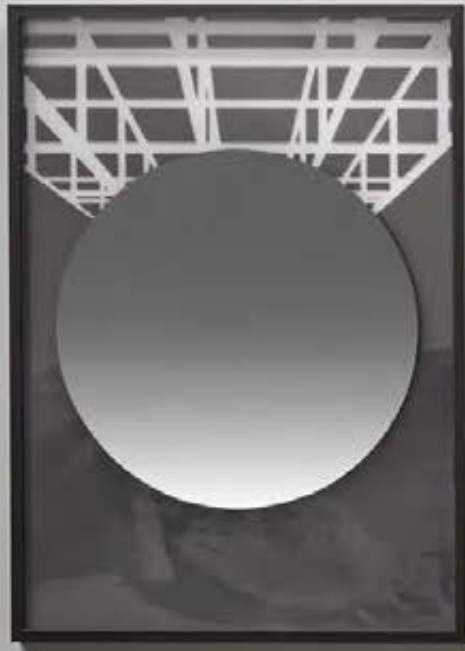

COLLAGE3314C  
L 54 H 75 P 5,4



Il fil rouge che lega l'arte al design è ormai un segno distintivo del lavoro che antoniolupi sta sviluppando al suo interno.

Più che parlare di contaminazione, vorremmo fare riferimento a due fasi esperienziali diverse che si fondono, trovando un obiettivo comune: una esperienza univoca del bello che possa entrare a far parte del quotidiano di ognuno di noi.

Luca Galofaro, Architetto e Professore, da tempo ha concentrato una parte della sua riflessione sulle relazioni esistenti fra rappresentazione, architettura urbana ed immagine.

Attualmente una ampia sezione dello show room Pietra e Fuoco della sede di Stabbia di antoniolupi è dedicata ad una Mostra/Collezione di Disegni di Architettura curata da Galofaro stesso: un passo di crescita aziendale di rilievo. Adesso Galofaro 'contamina' con la propria visione alcuni prodotti della antoniolupi e stringe ancora ancora di più questa collaborazione nata circa un anno fa con Andrea Lupi: alcuni dei Disegni di Architettura facenti parte della Mostra sono stati infatti selezionati ed applicati agli specchi della linea antoniolupi

L'idea di trasformare alcuni di questi lavori in oggetti di arredo è stata una conseguenza naturale delle riflessioni condivise fra Galofaro ed Andrea Lupi.

Si è trattato di trasformare un'immagine usata per pensare architettura trasferendola su un oggetto d'uso quotidiano, andando a costruire un ponte tra l'immaginazione che domina l'arte e la vita che è solitamente dominata dalla funzione che l'oggetto ha.

*The common thread between art and design is now a distinctive sign of antoniolupi's work.*

*More than fusion, we would refer to two different experiences mixed together to achieve a common goal: an univocal experience of beauty that becomes part of our daily life.*

*Luca Galofaro, Architect and Teacher, has focused his attention on relationships between representation, urban architecture and image.*

*An area of antoniolupi showroom La Pietra e il Fuoco in Stabbia is currently hosting an Exhibition/Architecture Drawing Collection curated by Galofaro himself: an important step forward in the company's growth strategy.*

*Now Galofaro 'influences' with his vision some antoniolupi products and the collaboration between him and Andrea Lupi is becoming even closer: some Architecture Drawings of the exhibition have been chosen to be used on antoniolupi mirrors collection.*

*Transforming some of these works in real furniture objects was a natural consequence of the reflection shared by Galofaro and Andrea Lupi.*

*The idea consists of transferring an image used to think of architecture to an item of everyday life, building a bridge between imagination, which dominates art, and life, normally dominated by the function of the object.*





La tecnica del collage si basa su una sovrapposizione di frammenti. L'immagine nasce come stratificazione di immagini della memoria. Gli specchi sono realizzati attraverso una stratificazione di lastre in vetro stampate e creano dei collage tridimensionali in cui l'ultimo strato specchiato definisce una relazione con l'osservatore che entra nell'immagine.



COLLAGE307  
L 54 H 75 P 5,4



*The collage technique is based on overlapping fragments. The image comes from the stratification of images of memory. Mirrors are made overlapping printed glass plates, creating tridimensional collages. The last mirrored layer established a relationship with the observer, who becomes part of the image itself.*

COLLAGE

COLLAGE314B

L 54 H 75 P 5,4



COLLAGE309  
L 54 H 75 P 5,4

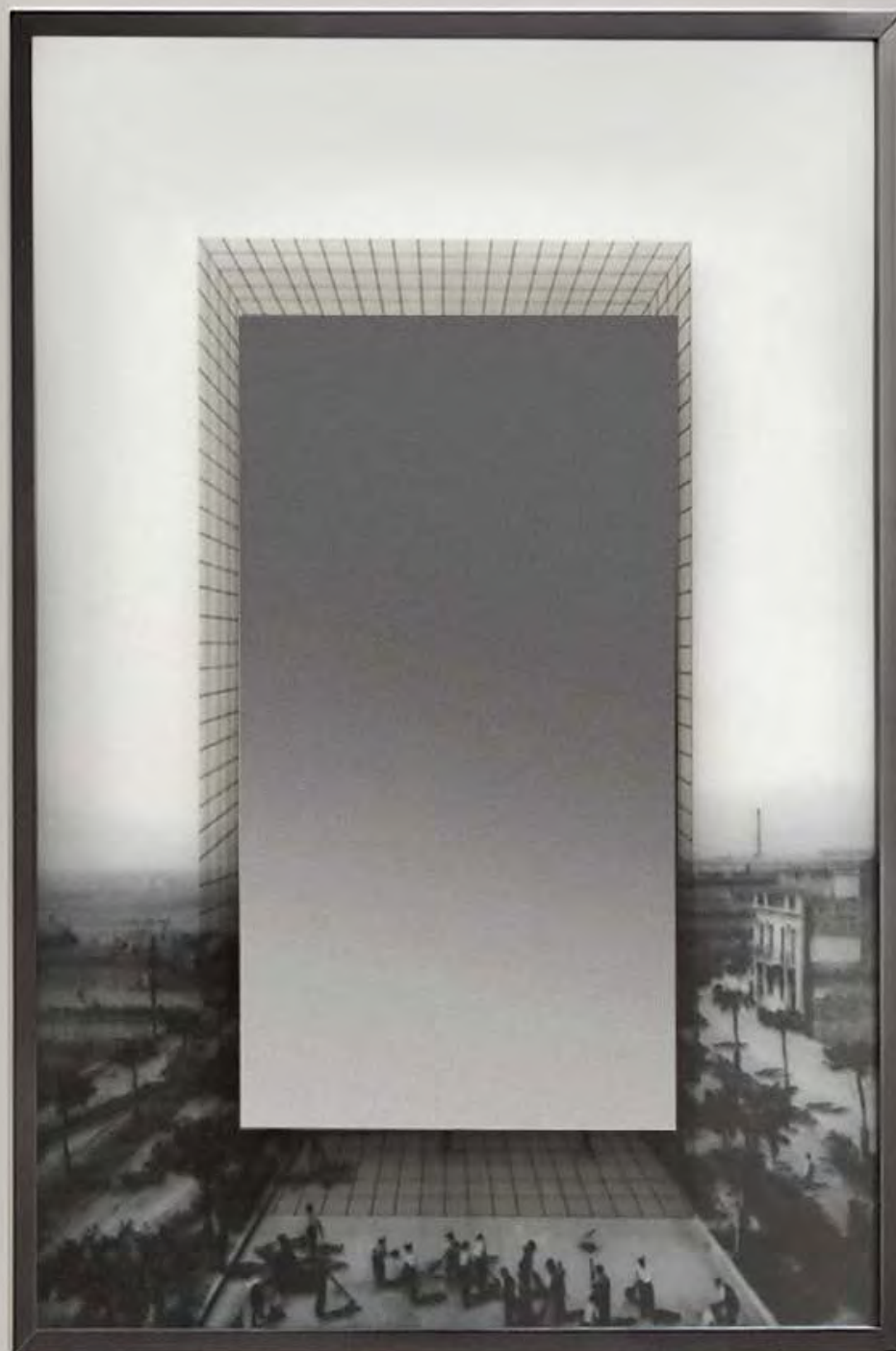



COLLAGE225  
L72 H75 P 4,2





COLLAGE

COLLAGE305

L 54 H 75 P 5,4



COLLAGE304  
L 75 H 50 P 5,4



COLLAGE303  
L 90 H 50 P 5,4

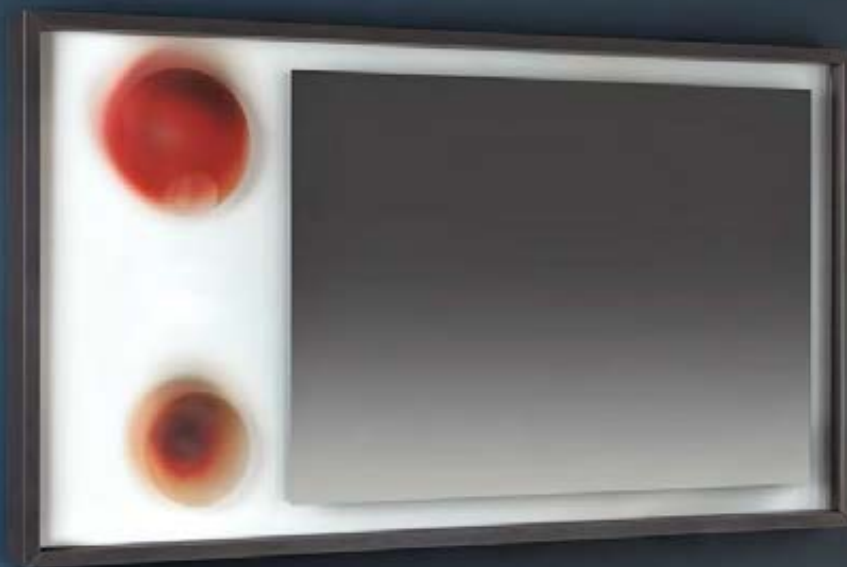





COLLAGE308  
L 75 H 50 P 5,4







COLLAGE317  
L 108 H 75 P 5,4



COLLAGE

COLLAGE306  
L 54 H 75 P 5,4







illuminazione a LED 4000 K. Su richiesta illuminazione a LED 3000 K senza maggiorazione di prezzo.

*LED lighting 4000 K. Upon request LED lighting 3000 K available without additional surcharge.*











P	L	H	art.
2,5	da / from 54 a / to 216	50	NEUTRO50
		75	NEUTRO75
		90	NEUTRO90
		100	NEUTRO100
		110	NEUTRO110

Specchio spess. 5 mm a filo lucido orizzontale o verticale, completo di telaio nero.

*Polished edge mirror 5 mm thick mounted horizontally or vertically, complete with black frame.*

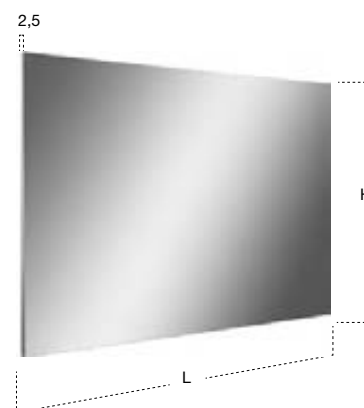

LUCENTE design AL Studio

illuminazione a led diretta

*direct led lighting*



illuminazione a led indiretta

*indirect led lighting*









Per mercato USA e Canada  
For US and Canadian markets

P	H	* L	art.	art.	
4,5	9	45	LUCENTE45	LUCENTES45	12,96 W
		54	LUCENTE54	LUCENTES54	15,55 W
		63	LUCENTE63	LUCENTES63	18,14 W
		72	LUCENTE72	LUCENTES72	20,75 W
		81	LUCENTE81	LUCENTES81	23,35 W
		90	LUCENTE90	LUCENTES90	25,95 W
		99	LUCENTE99	LUCENTES99	28,54 W
		108	LUCENTE108	LUCENTES108	31,14 W
		117	LUCENTE117	LUCENTES117	33,73 W
		126	LUCENTE126	LUCENTES126	36,32 W
		135	LUCENTE135	LUCENTES135	38,92 W
		144	LUCENTE144	LUCENTES144	41,51 W
		153	LUCENTE153	LUCENTES153	44,10 W
		162	LUCENTE162	LUCENTES162	46,70 W
		171	LUCENTE171	LUCENTES171	49,29 W
		180	LUCENTE180	LUCENTES180	51,89 W
		189	LUCENTE189	LUCENTES189	54,48 W
		198	LUCENTE198	LUCENTES198	57,08 W
		207	LUCENTE207	LUCENTES207	59,67 W
		216	LUCENTE216	LUCENTES216	62,27 W

Lampada in alluminio verniciato nero con illuminazione a led diretta e indiretta, cover in vetro argentato compatibile con specchi NEUTRO e NEUTROLED.

N.B. Per applicazione su specchi NEUTROLED, occorre inserirla ad una distanza minima dal bordo superiore di 9 cm.

*Black lacquered aluminum lamp with direct and indirect led-lighting, cover in silvered glass  
P.S. The minimum distance from the upper border for installation on NEUTROLED mirrors is 9 cm*

illuminazione a LED 4000 K. Su richiesta illuminazione a LED 3000 K senza maggiorazione di prezzo.

*LED lighting 4000 K. Upon request LED lighting 3000 K available without additional surcharge.*

\* Misure standard / Standard measures

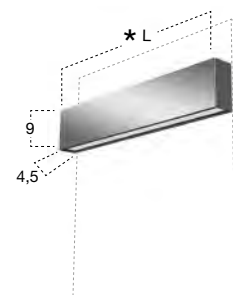



illuminazione a LED 4000 K. Su richiesta illuminazione a LED 3000 K senza maggiorazione di prezzo.

LED lighting 4000 K. Upon request LED lighting 3000 K available without additional surcharge.

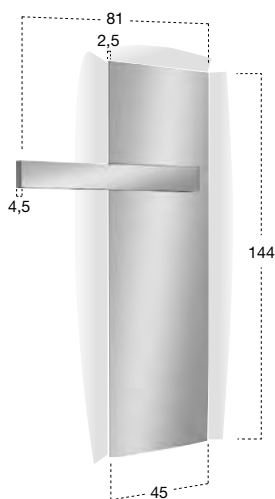

Versione sx

Left version

444

H	L	ART.
144	45	NEULUCE1 (L 81)

Specchio spess. 5 mm a filo lucido con illuminazione a led luce bianca, completo di telaio e lampada Art. LUCENTE72 versione dx o sx.

Polished edge mirror 5 mm thick with white led lighting complete with frame and lamp Art. LUCENTE72, right or left hand version.



Illuminazione a LED 4000 K. Su richiesta illuminazione a LED 3000 K senza maggiorazione di prezzo.

*LED lighting 4000 K. Upon request LED lighting 3000 K available without additional surcharge.*

Ø	ART.	
90	CIRCUS190W	(L 112,5)
108	CIRCUS1108W	(L 135)

Specchio spess. 5 mm a filo lucido con illuminazione a led luce bianca, completo di telaio e lampada LUCENTE versione dx o sx.

*Polished edge mirror 5 mm thick with white led lighting, complete with frame and lamp art. LUCENTE, right or left hand version.*

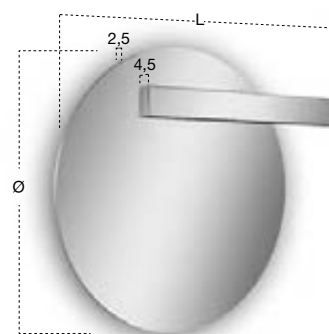

Versione dx

Right version



illuminazione a LED 4000 K. Su richiesta illuminazione a LED 3000 K senza maggiorazione di prezzo.

LED lighting 4000 K. Upon request LED lighting 3000 K available without additional surcharge.

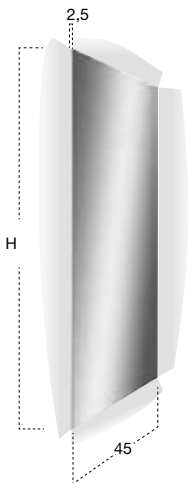

P	L	H	art.
2,5	45	144	NEUTRO1144W45
	45	180	NEUTRO1180W45

Specchio spess. 5 mm a filo lucido con illuminazione a led luce bianca, completo di telaio.

Polished edge mirror 5 mm thick with white led lighting, complete with frame.



Illuminazione a LED 4000 K. Su richiesta illuminazione a LED 3000 K senza maggiorazione di prezzo.

*LED lighting 4000 K. Upon request LED lighting 3000 K available without additional surcharge.*

P	L	H	art.
2,5	da / from 54 a / to 216	50	NEUTROLED50W
		75	NEUTROLED75W
		90	NEUTROLED90W
		100	NEUTROLED100W
		110	NEUTROLED110W
		125	NEUTROLED125W
		142	NEUTROLED142W

Specchio spess. 5 mm a filo lucido orizzontale o verticale con illuminazione a led luce bianca, completo di telaio.

*Polished edge mirror 5 mm thick mounted horizontally or vertically with white led lighting complete with frame.*

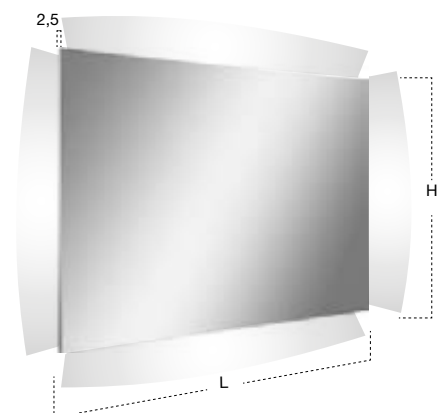





illuminazione a LED 4000 K. Su richiesta illuminazione a LED 3000 K senza maggiorazione di prezzo.

LED lighting 4000 K. Upon request LED lighting 3000 K available without additional surcharge.

P	L	H	art.
2,5	54	210	NEUTRO210W54
	72	210	NEUTRO210W72
	90	210	NEUTRO210W90

Specchio spess. 5 mm a filo lucido con illuminazione a led luce bianca, completo di telaio.

Polished edge mirror 5 mm thick with white led lighting, complete with frame.

P	L	H	art.
2,5	54	210	NTKIT210W54
	72	210	NTKIT210W72
	90	210	NTKIT210W90

Specchio spess. 5 mm a filo lucido con illuminazione a led luce bianca, completo di telaio predisposto per corpo ad incasso Art. SP201INSA, Art. SP201INLU.

Polished edge mirror 5 mm thick complete with frame and white led lighting prepared for concealed valves Art. SP201INSA, Art. SP201INLU.

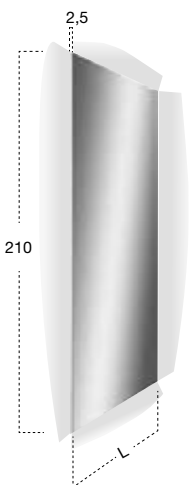



Illuminazione a LED 4000 K. Su richiesta illuminazione a LED 3000 K senza maggiorazione di prezzo.

LED lighting 4000 K. Upon request LED lighting 3000 K available without additional surcharge.

P	L	H	art.
2,5	da / from 54 a / to 216	50	NTKIT50W
		75	NTKIT75W
		90	NTKIT90W
		100	NTKIT100W
		110	NTKIT110W
		125	NTKIT125W
		142	NTKIT142W

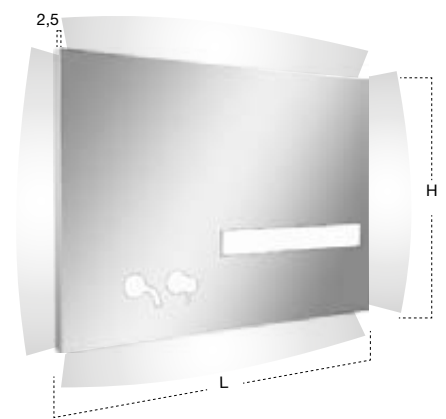

Specchio spess. 5 mm a filo lucido orizzontale o verticale con illuminazione a led luce bianca, completo di telaio predisposto per corpo ad incasso Art. SP201INSA, Art. SP201INLU e/o porta salviette RETTA.

Polished edge mirror 5 mm thick mounted horizontally or vertically complete with frame and white led lighting prepared for concealed valves Art. SP201INSA, Art. SP201INLU and/or towel rail Art. RETTA.



illuminazione a LED 4000 K. Su richiesta illuminazione a LED 3000 K senza maggiorazione di prezzo.

LED lighting 4000 K. Upon request LED lighting 3000 K available without additional surcharge.



P	L	H	art.	art.
2,5	72	72	MODULO872	MODULO872W Con illuminazione a led / With led lighting
	90	90	MODULO890	MODULO890W Con illuminazione a led / With led lighting
	108	108	MODULO8108	MODULO8108W Con illuminazione a led / With led lighting

Specchio spess. 5 mm a filo lucido con o senza illuminazione a led luce bianca, completo di telaio.

Polished edge mirror 5 mm thick with or without white led lighting, complete with frame.

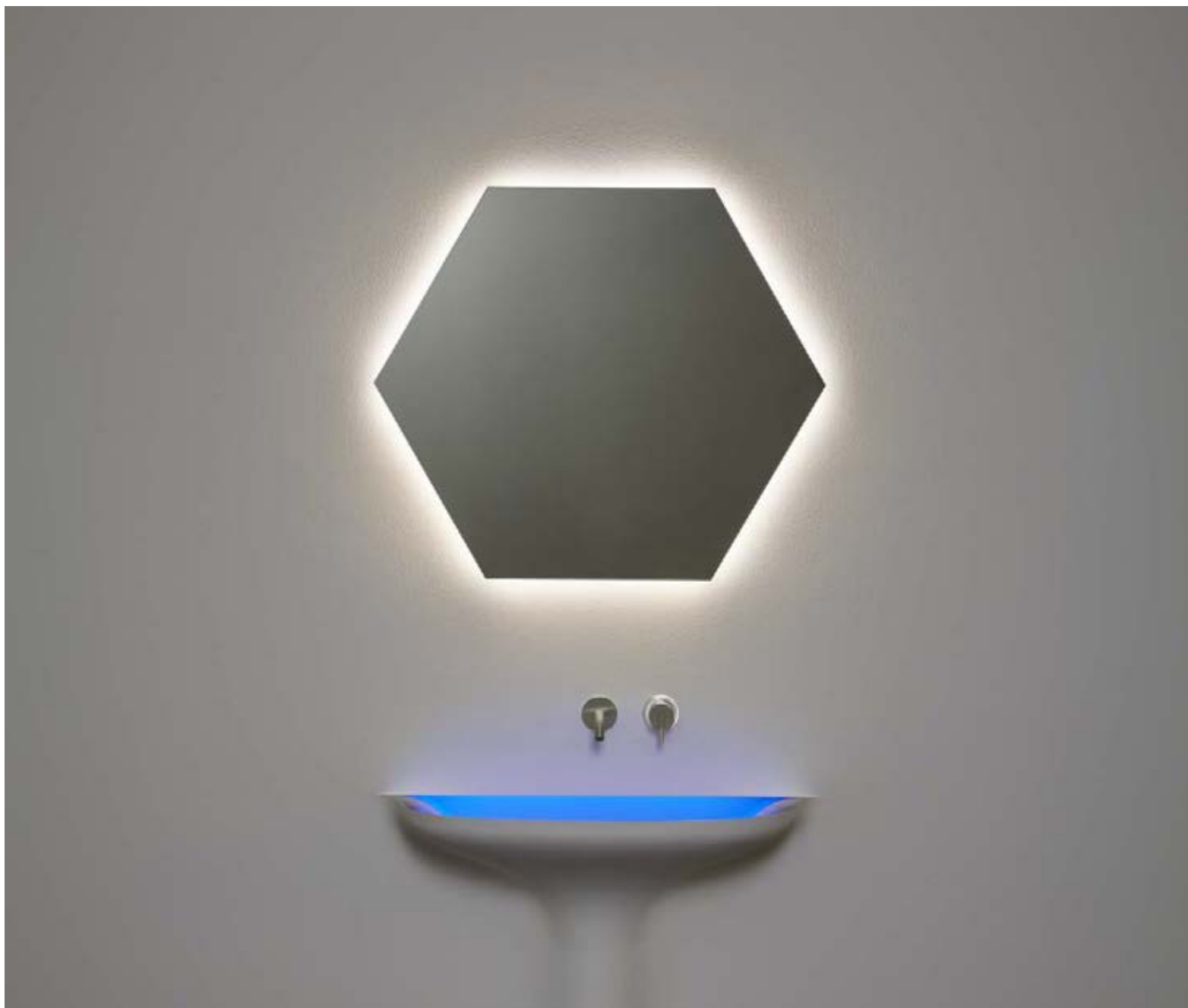

illuminazione a LED 4000 K. Su richiesta illuminazione a LED 3000 K senza maggiorazione di prezzo.

LED lighting 4000 K. Upon request LED lighting 3000 K available without additional surcharge.

P	L	H	art.	art.
2,5	72	62	MODULO672	MODULO672W Con illuminazione a led / With led lighting
	90	78	MODULO690	MODULO690W Con illuminazione a led / With led lighting
	108	94	MODULO6108	MODULO6108W Con illuminazione a led / With led lighting

Specchio spess. 5 mm a filo lucido con o senza illuminazione a led luce bianca, completo di telaio.

Polished edge mirror 5 mm thick with or without white led lighting, complete with frame.

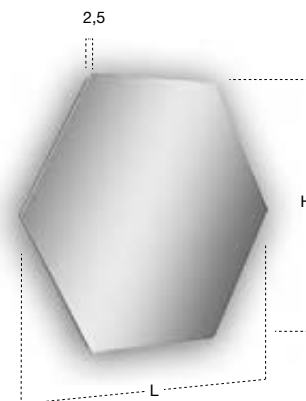







Illuminazione a LED 4000 K. Su richiesta illuminazione a LED 3000 K senza maggiorazione di prezzo.

LED lighting 4000 K. Upon request LED lighting 3000 K available without additional surcharge.

P	∅	art.	art.
2,5	72	CIRCUS72	CIRCUS72W Con illuminazione a led / With led lighting
	90	CIRCUS90	CIRCUS90W Con illuminazione a led / With led lighting
	108	CIRCUS108	CIRCUS108W Con illuminazione a led / With led lighting
	120	CIRCUS120	CIRCUS120W Con illuminazione a led / With led lighting
	140	CIRCUS140	CIRCUS140W Con illuminazione a led / With led lighting

Specchio spess. 5 mm a filo lucido con o senza illuminazione a led luce bianca, completo di telaio.

Polished edge mirror 5 mm thick with or without white led lighting, complete with frame.

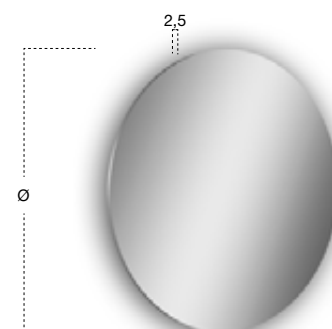



illuminazione a LED 4000 K. Su richiesta illuminazione a LED 3000 K senza maggiorazione di prezzo.

LED lighting 4000 K. Upon request LED lighting 3000 K available without additional surcharge.

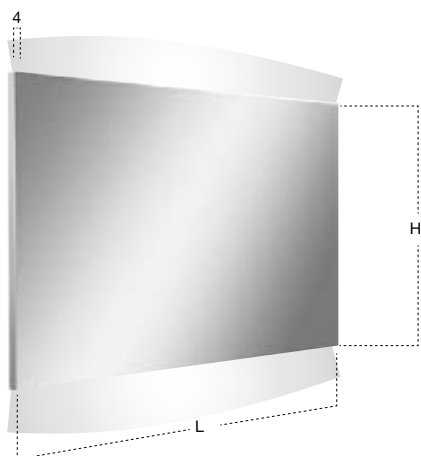

P	L	H	art.
4	da / from 72 a / to 216	50	FLASH50W
		75	FLASH75W
		90	FLASH90W
		100	FLASH100W



Per mercato USA e Canada  
For US and Canadian markets

P	L	H	art.
4	da / from 72 a / to 216	50	FLASH050S
		75	FLASH075S
		90	FLASH090S
		100	FLASH100S

Specchio spess. 5 mm a filo lucido con illuminazione a led luce bianca, completo di telaio in acciaio lucido AISI 304.

N.B. Su richiesta è possibile avere illuminazione a led bianca e blu.

Polished edge mirror 5 mm thick with white led lighting, complete with polished steel frame AISI 304.  
P.S. Upon request it is possible to have white and blue led lighting.



illuminazione a LED 4000 K. Su richiesta illuminazione a LED 3000 K senza maggiorazione di prezzo.

LED lighting 4000 K. Upon request LED lighting 3000 K available without additional surcharge.

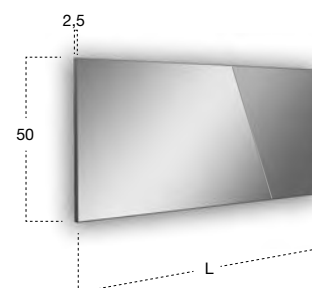

P	L	H	art.	art.
2,5	da / from 90 a / to 216	50	APICE50	APICE50W Con illuminazione a led / With led lighting

Specchio spess. 4 mm a filo lucido con o senza illuminazione a led luce bianca e inserto argentato fumé o bronzo, completo di telaio nero.

Polished edge mirror 4 mm thick with or without white led lighting and fumé or bronze silvered insert, complete with black frame.

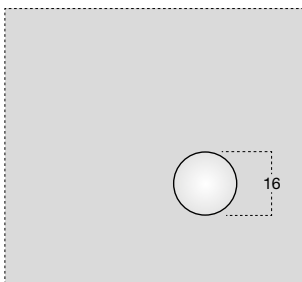

H	art.
50	FOCUS50
75	FOCUS75
90	FOCUS90
100	FOCUS100
110	FOCUS110

Ingranditore 2x completo di piastra magnetica, per specchi Art. VARIO, Art. VERTICE e Art. FILA.

*Magnifying mirror 2x complete with magnetic plate for mirrors Art. VARIO, Art. VERTICE and Art. FILA.*

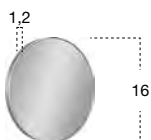

Ø	P	art.
16	1,2	FOCUS

Secondo ingranditore 2x.

*Second magnifying mirror 2x.*



illuminazione a LED 4000 K. Su richiesta illuminazione a LED 3000 K senza maggiorazione di prezzo.

LED lighting 4000 K. Upon request LED lighting 3000 K available without additional surcharge.

\* Misure standard / Standard measures

L 54 - 63 - 72 - 81 - 90 - 99 - 108 - 117 - 126 - 135 - 144 - 153 - 162  
171 - 180 - 189 - 198 - 207 - 216

P	L	H	art.
2,5	*	50	VARIO50W
		75	VARIO75W
		90	VARIO90W
		100	VARIO100W
		110	VARIO110W

Specchio spess. 4 mm a filo lucido con illuminazione a led, luce bianca completo di telaio.

Polished edge mirror 4 mm thick with white led lighting and frame.

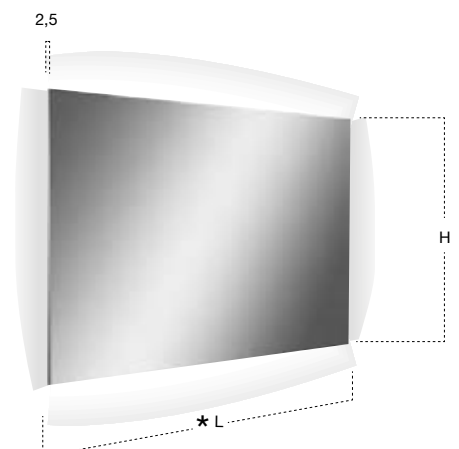





illuminazione a LED 4000 K. Su richiesta illuminazione a LED 3000 K senza maggiorazione di prezzo.

LED lighting 4000 K. Upon request LED lighting 3000 K available without additional surcharge.

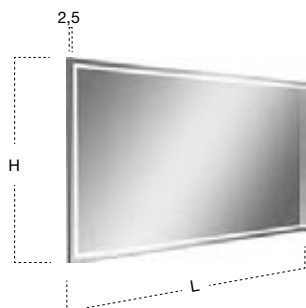

P	L	H	art.
2,5	da / from 72 a / to 216	75	FILA75W
		90	FILA90W

Specchio spess. 4 mm a filo lucido con illuminazione a led luce bianca, completo di telaio nero.

Polished edge mirror 4 mm thick with white led lighting, complete with black frame.



Illuminazione a LED 4000 K. Su richiesta illuminazione a LED 3000 K senza maggiorazione di prezzo.

LED lighting 4000 K. Upon request LED lighting 3000 K available without additional surcharge.

P	L	H	art.
2,5	da / from 72 a / to 216	75	VERTICE75W
		90	VERTICE90W

Specchio spess. 4 mm a filo lucido con illuminazione a led luce bianca, completo di telaio nero.

Polished edge mirror 4 mm thick with white led lighting, complete with black frame.

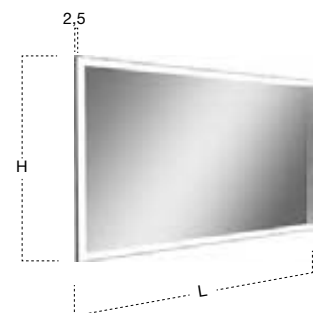



illuminazione a LED 4000 K. Su richiesta illuminazione a LED 3000 K senza maggiorazione di prezzo.

LED lighting 4000 K. Upon request LED lighting 3000 K available without additional surcharge.

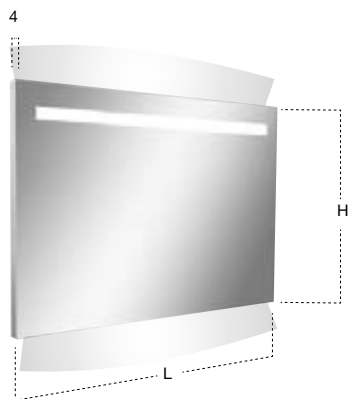

P	L	H	art.
4	da / from 72 a / to 216	50	SPIO650W
		75	SPIO675W
 Per mercato USA e Canada For US and Canadian markets			
P	L	H	art.
4	da / from 72 a / to 216	50	LAMP0050S
		75	LAMP0075S

Specchio spess. 5 mm a filo lucido con illuminazione a led luce bianca, completo di telaio in acciaio lucido AISI 304.

N.B. Su richiesta è possibile avere illuminazione a led bianca e blu.

Polished edge mirror 5 mm thick with white led lighting, complete with polished steel frame AISI 304.  
P.S. Upon request it is possible to have white and blue led lighting.



illuminazione a LED 4000 K. Su richiesta illuminazione a LED 3000 K senza maggiorazione di prezzo.

LED lighting 4000 K. Upon request LED lighting 3000 K available without additional surcharge.

P	L	H	art.
4	da / from 72 a / to 216	50	SPIO150W
		75	SPIO175W
 Per mercato USA e Canada For US and Canadian markets			
P	L	H	art.
4	da / from 72 a / to 216	50	SPIO1050S
		75	SPIO1075S

Specchio spess. 5 mm a filo lucido con illuminazione a led luce bianca, completo di telaio in acciaio lucido AISI 304.

N.B. Su richiesta è possibile avere illuminazione a led bianca e blu.

Polished edge mirror 5 mm thick with white led lighting, complete with polished steel frame AISI 304.  
P.S. Upon request it is possible to have white and blue led lighting.

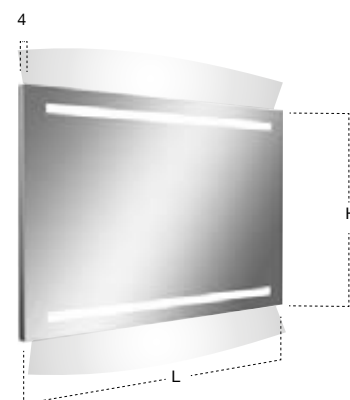



Illuminazione a LED 4000 K. Su richiesta illuminazione a LED 3000 K senza maggiorazione di prezzo.

LED lighting 4000 K. Upon request LED lighting 3000 K available without additional surcharge.

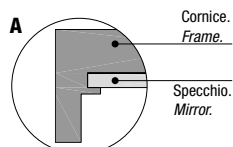
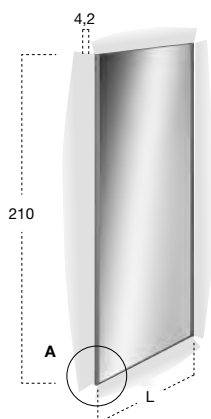

P	L	H	art.	
4,2	54	210	BSK21054	BSK210W54 Con illuminazione a led / With led lighting
	72	210	BSK21072	BSK210W72 Con illuminazione a led / With led lighting
	90	210	BSK21090	BSK210W90 Con illuminazione a led / With led lighting

Specchio spess. 4 mm a filo lucido orizzontale o verticale e cornice in alluminio alluminio, finitura bronzo, titanio, zirconio o champagne, con o senza illuminazione a led.

Horizontal or vertical polished edge mirror 4 mm thick and aluminum frame finish bronze, titanium, zirconium or champagne, with or without led lighting





Illuminazione a LED 4000 K. Su richiesta illuminazione a LED 3000 K senza maggiorazione di prezzo.

LED lighting 4000 K. Upon request LED lighting 3000 K available without additional surcharge.

P	L	H	art.	art.
4,2	da / from 54 a / to 216	50	BSK50	BSK50W Con illuminazione a led / With led lighting
		75	BSK75	BSK75W Con illuminazione a led / With led lighting
		90	BSK90	BSK90W Con illuminazione a led / With led lighting
		100	BSK100	BSK100W Con illuminazione a led / With led lighting
		110	BSK110	BSK110W Con illuminazione a led / With led lighting

Specchio spess. 4 mm a filo lucido orizzontale o verticale e cornice in alluminio, finitura bronzo, titanio, zirconio o champagne, con o senza illuminazione a led.

Horizontal or vertical polished edge mirror 4 mm thick and aluminum frame finish bronze, titanium, zirconium or champagne, with or without led lighting

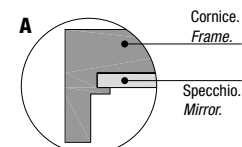
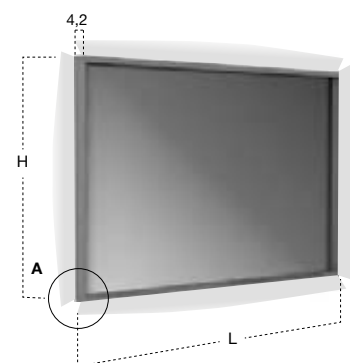

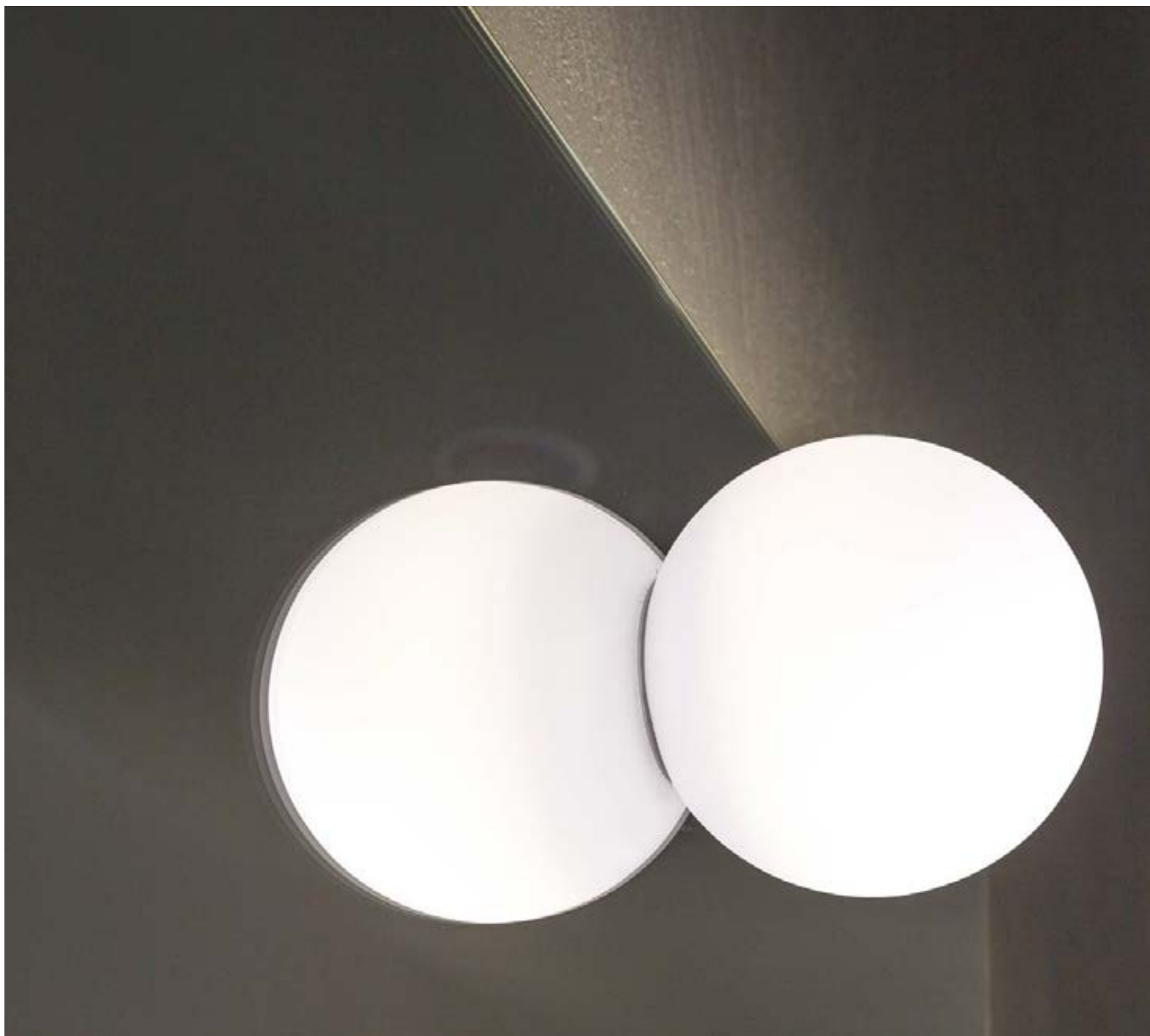

$\varnothing$  art.

8 BOLLA

Lampada a led da specchio in vetro pyrex con supporto in alluminio, completa di lampada e trasformatore.

*Led lamp in pyrex glass with aluminum support, complete with bulb and transformer.*



Ø	art.
8	BOLLA2

Coppia di lampade a led da specchio in vetro pyrex con supporto in alluminio, complete di lampada e trasformatore.

*Pair of led lamps in pyrex glass with aluminum support, complete with bulb and transformer.*



# BOLLA



Ø art.  
12 BOLLA1

Lampada da specchio e da parete in vetro pyrex con supporto in alluminio completa di lampada.

*Mirror or wall lamp in pyrex glass with aluminum support, complete with bulb.*



Illuminazione a LED 4000 K. Su richiesta illuminazione a LED 3000 K senza maggiorazione di prezzo.

LED lighting 4000 K. Upon request LED lighting 3000 K available without additional surcharge.

CORNICE (La realizzazione della cornice è a cura del cliente)  
FRAME (frame not included)

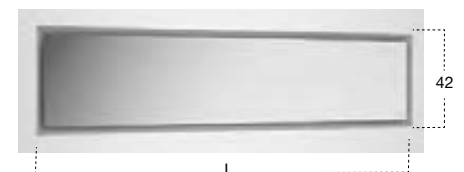
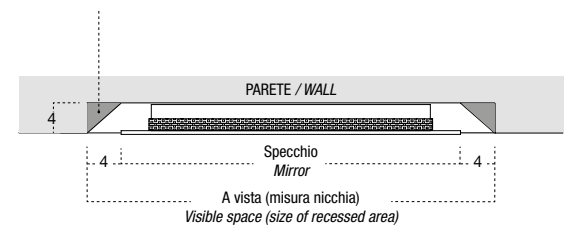

P	L	H	art.
4	da / from 64 a / to 208	42	PERIPLO

Specchio spess. 5 mm a filo lucido orizzontale o verticale con illuminazione a led bianco, da incasso a parete.

Encased wall mount polished edge mirror 5 mm thick with white led lighting, mounted horizontally or vertically.



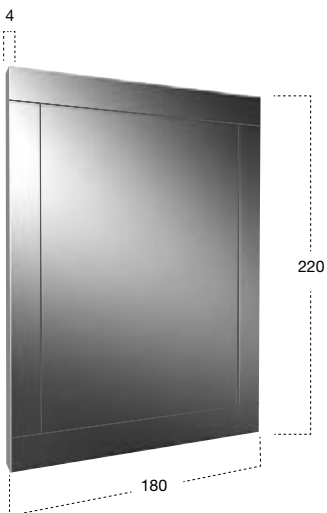

P	L	H	art.
4	180	220	DAMONE

Specchio spess. 5 mm a filo lucido con cornice a disegno completo di telaio laccato nero gofrato.

*Polished edge mirror 5 mm thick complete with lacquered frame embossed black.*



P	H	L	art.
2,4	50	54 / 108 / 144 / 216	RISMA50
P	H	L	art.
2,4	75	108	RISMA75
P	H	L	art.
2,4	110	108	RISMA110

Specchio argentato naturale, bronzo o fumè spess. 4 mm a filo lucido orizzontale o verticale, completo di telaio nero.

N.B. Per misure non elencate nel presente catalogo, consultare l'Azienda.

*Polished edge mirror 4 mm thick complete with black frame mounted horizontal or vertical in natural, bronze or fume finish.*

*P.S. For sizes not listed in the current catalogue please consult the company.*

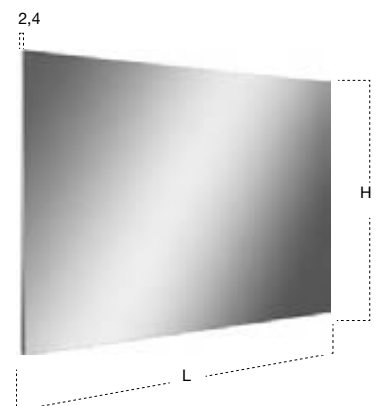







# LUXOR

Cristallo argentato fumé

*Fumé silvered glass*





Cristallo argentato blu

*Blu silvered glass*

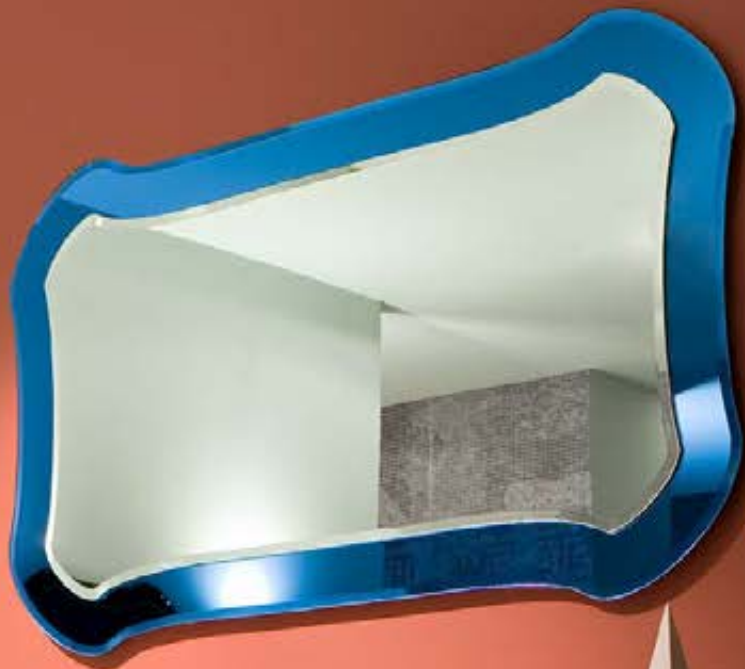

# LUXOR

Cristallo argentato bronzo

*Bronze silvered glass*



Cristallo argentato bronzo

*Bronze silvered glass*



# LUXOR

Specchio spess. 5 mm tondo molato.

*Beveled round mirror 5 mm thick.*

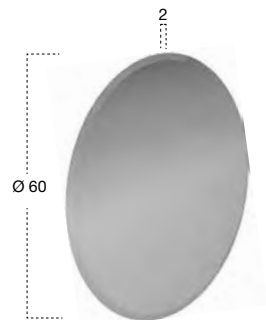

P	∅	art.	
2	60	LUXOR1	

Specchio spess. 5 mm quadrato molato.

*Beveled square mirror 5 mm thick.*

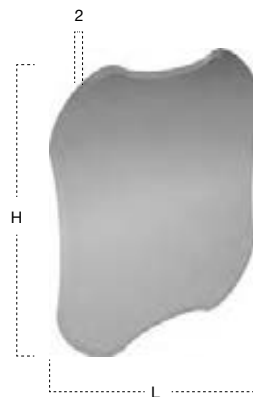

P	L	H	art.
2	75	75	LUXOR475
	90	90	LUXOR490

Specchio spess. 5 mm ovale orizzontale o verticale molato.

*Horizontal or vertical beveled oval mirror 5 mm thick.*

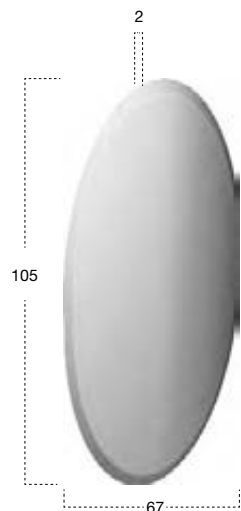

P	L	H	art.
2	67	105	LUXOR2

Specchio spess. 5 mm rettangolare orizzontale o verticale molato.

*Horizontal or vertical beveled rectangular mirror 5 mm thick.*

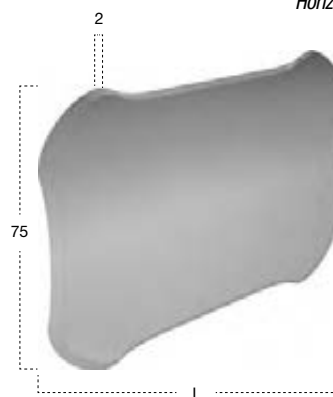

P	L	H	art.
2	117	75	LUXOR5117
	126	75	LUXOR5126

Specchio spess. 5 mm tondo molato.

*Beveled round mirror 5 mm thick.*

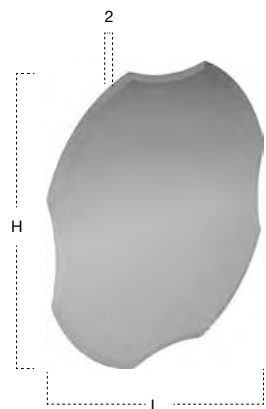

P	L	H	art.
2	75	75	LUXOR375
	90	90	LUXOR390

Specchio spess. 5 mm ovale orizzontale o verticale molato.

*Horizontal or vertical beveled oval mirror 5 mm thick.*

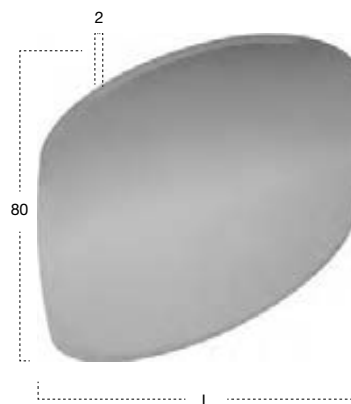

P	L	H	art.
2	117	80	LUXOR6117
	126	80	LUXOR6126

Specchio spess. 5 mm tondo molato con cornice in cristallo colorato argentato disponibile nei diversi colori: fumé, bronzo, rosé, blu, acquamarina.

*Round beveled mirror 5 mm thick with a coloured and silvered glass frame available in various colours: fumé, bronze, rosé, blu and acquamarina.*

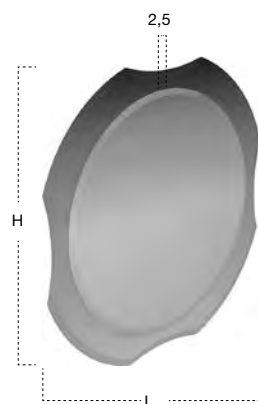

Specchio spess. 5 mm rettangolare orizzontale o verticale molato con cornice in cristallo colorato argentato disponibile nei diversi colori: fumé, bronzo, rosé, blu, acquamarina.

*Rectangular beveled mirror 5 mm thick horizontal or vertical, with a coloured and silvered glass frame available in various colours: fumé, bronze, rosé, blu and acquamarina.*



P	L	H	art.
2,5	75	75	LUXOR775
	90	90	LUXOR790

P	L	H	art.
2,5	117	75	LUXOR9117
	126	75	LUXOR9126

Specchio spess. 5 mm quadrato con cornice in cristallo colorato argentato disponibile nei diversi colori: fumé, bronzo, rosé, blu e acquamarina.

*Round beveled mirror 5 mm thick with a coloured and silvered glass frame available in various colours: fumé, bronze, rosé, blu and acquamarina.*

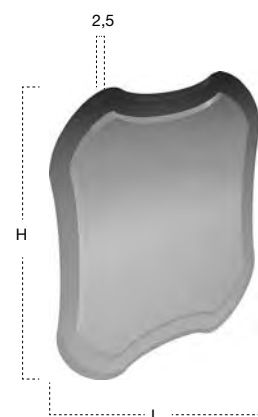

Specchio spess. 5 mm ovale orizzontale o verticale, molato con cornice in cristallo colorato argentato disponibile nei diversi colori: fumé, bronzo, rosé, blu e acquamarina.

*Oval beveled mirror 5 mm thick horizontal or vertical, with a coloured and silvered glass frame available in various colours: fumé, bronze, rosé, blu and acquamarina.*

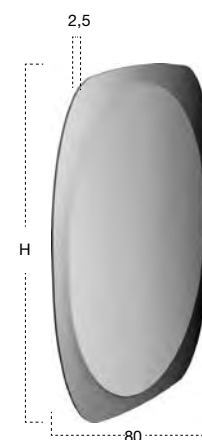

P	L	H	art.
2,5	75	75	LUXOR875
	90	90	LUXOR890

P	L	H	art.
2,5	117	80	LUXOR10117
	126	80	LUXOR10126





Art. PRESA / PRESACH



N. 2 prese di corrente per pensili.

N. 2 electrical sockets for wall cabinets.

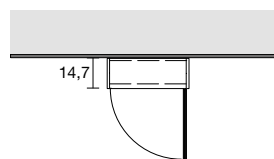
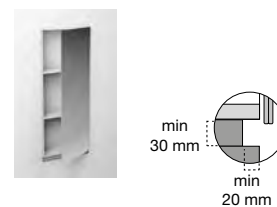
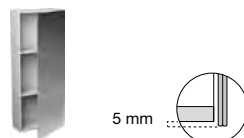
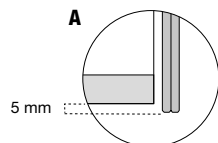
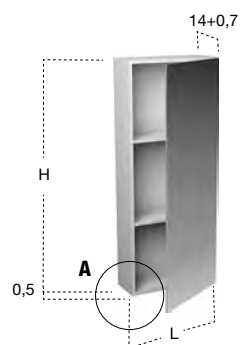

a Pensile a parete  
Wall cabinet

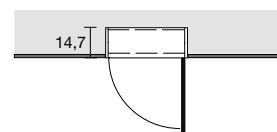

b Pensile incassato a parete  
Encased wall cabinet

P	L	H	art.
14,7	36/45/54	50	MANTRA150
		75	MANTRA175
		90	MANTRA190

Pensile dx o sx con 1 anta a specchio bifacciale e 1 ripiano interno per H 50 cm o 2 ripiani interni per H 75 e H 90 cm.

Right or left wall cabinet with 1 double face mirrored door and 1 internal shelf for H 50 cm or with 2 internal shelves for H 75 and H 90 cm.



Art. PRESA / PRESACH

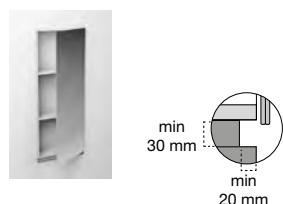
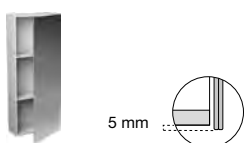

N. 2 prese di corrente per pensili.  
N. 2 electrical sockets for wall cabinets.

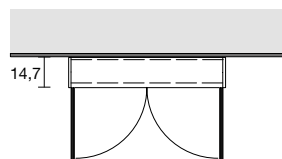

a Pensile a parete  
Wall cabinet

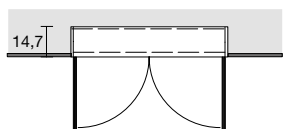

b Pensile incassato a parete  
Encased wall cabinet

P	L	H	art.
14,7	72/90/108	50	MANTRA250
		75	MANTRA275
		90	MANTRA290

Pensile con 2 ante a specchio bifacciali e 1 ripiano interno per H 50 cm o 2 ripiani interni per H 75 e H 90 cm.

Wall cabinet with 2 double face mirrored door and 1 internal shelf for H 50 cm or with 2 internal shelves for H 75 and H 90 cm.

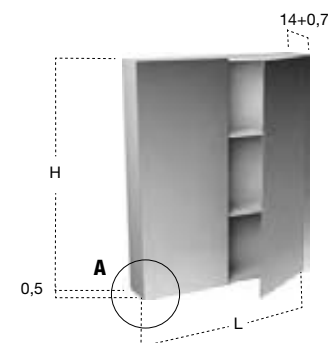
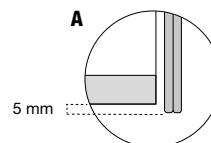

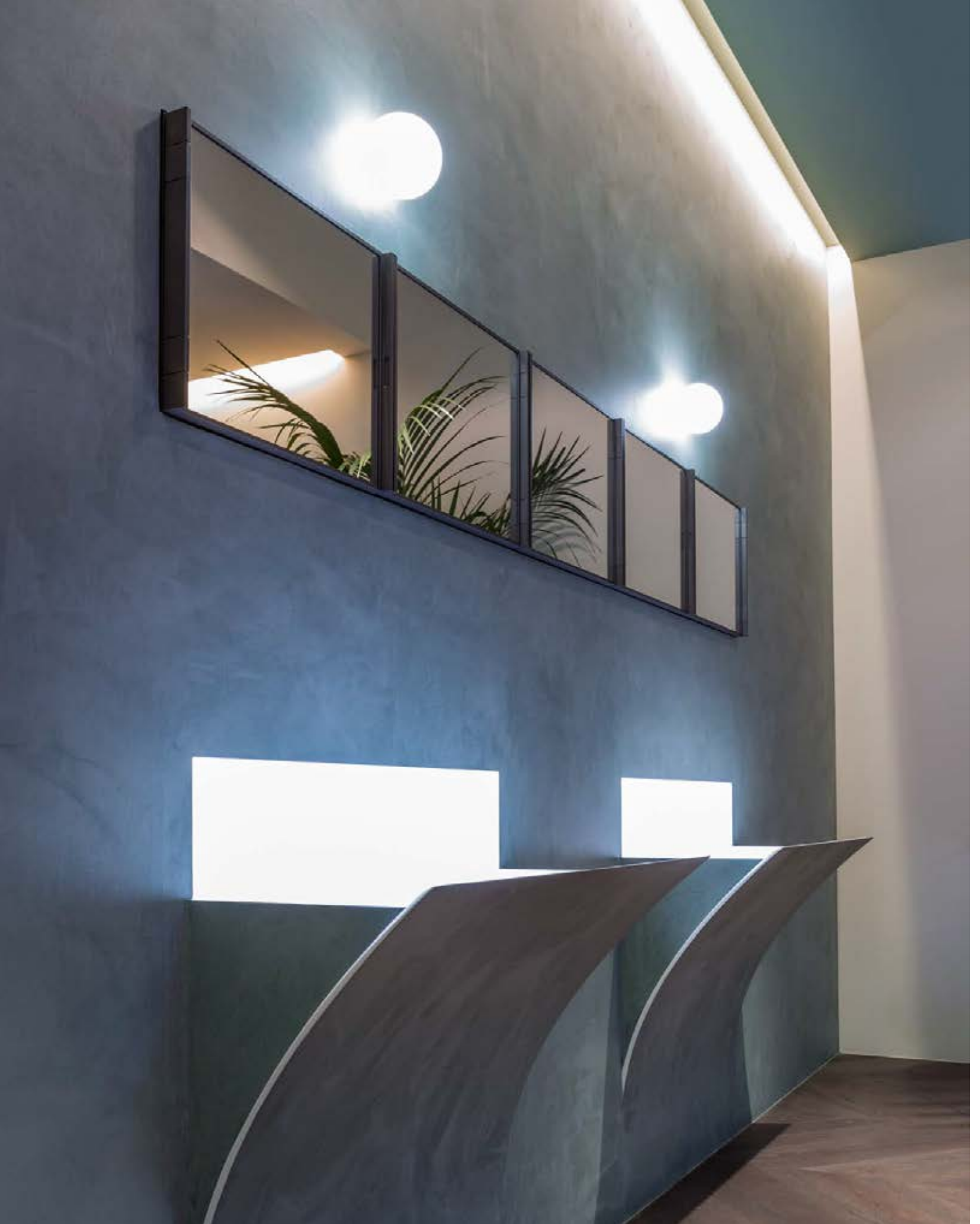

Su richiesta è possibile inserire all'interno dell'anta un secondo specchio.  
 On request it is possible to insert a second mirror on the inside of the door front.



P	L	H	art.
21,6	36	37,5	KE1136
	45	37,5	KE1145

P	L	H	art.
21,6	72	37,5	KE3172
	90	37,5	KE3190

P	L	H	art.
21,6	36	50	KE1436
	45	50	KE1445
	54	50	KE1454

P	L	H	art.
21,6	72	50	KE3472
	90	50	KE3490
	108	50	KE34108

Pensile con 1 o 2 ante e 1 ripiano interno solo per H 50 cm.

Wall cabinet with 1 or 2 doors and 1 internal shelf for H 50 cm.

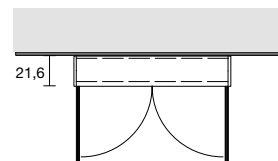

a Pensile a parete  
Wall cabinet

Art. KE1136 / KE1145  
Versione sx / Left version

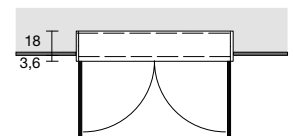

b Pensile semincasso a parete  
Semi-encased wall cabinet

Art. KE3172 / KE3190

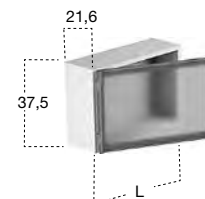

Art. KE1436 / KE1445 / KE1454  
Versione sx / Left version

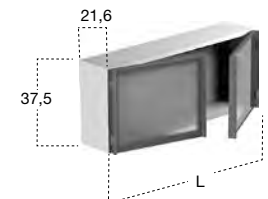

Art. KE3472 / KE3490 / KE34108

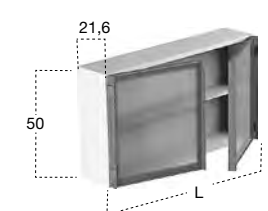
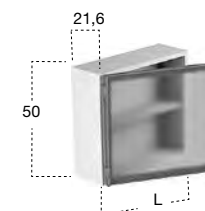

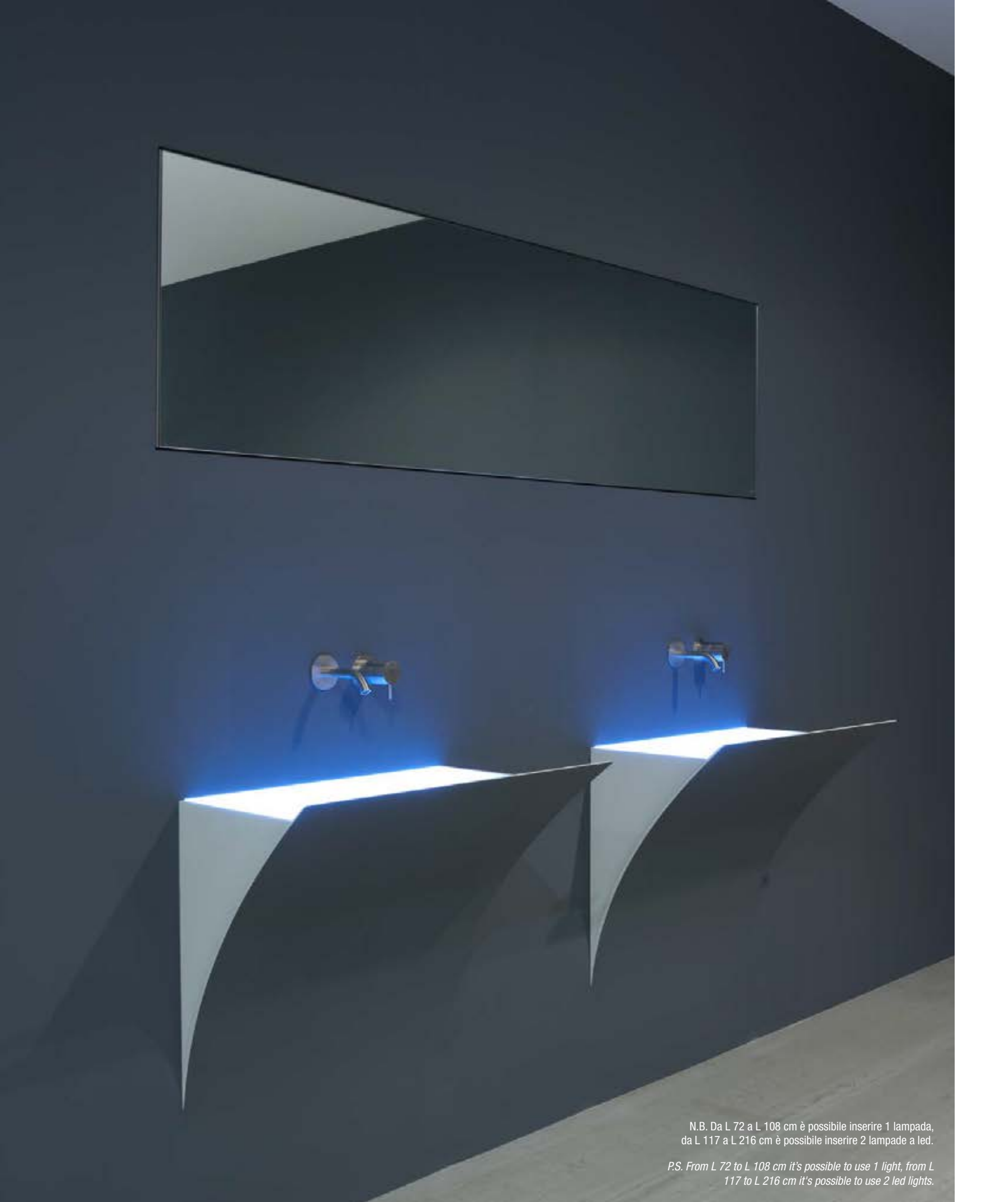

N.B. Da L 72 a L 108 cm è possibile inserire 1 lampada,  
da L 117 a L 216 cm è possibile inserire 2 lampade a led.

*P.S. From L 72 to L 108 cm it's possible to use 1 light, from L  
117 to L 216 cm it's possible to use 2 led lights.*



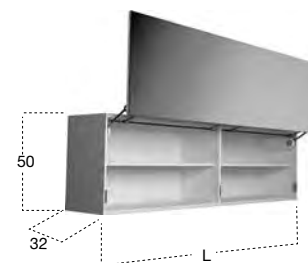

Specchio.  
Mirror.



P	L	H	art.
32	da / from 72 a / to 216	50	SEGRETO

Pensile con anta a specchio ad apertura verticale, mediante sistema elettrico con possibile inserimento di illuminazione a led.

*Wall cabinet with vertical electrical flap-opening door. Upon request it can be produced with internal led lighting.*





# TEATRO

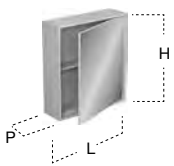

P	L	H	art.
14	27/36/45/54	50	TEATRO15014
		75	TEATRO17514
		100	TEATRO10014
		125	TEATRO12514

P	L	H	art.
22	27/36/45/54	50	TEATRO15022
		75	TEATRO17522
		100	TEATRO10022
		125	TEATRO12522

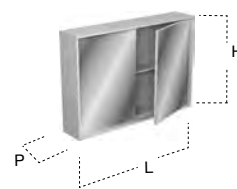

P	L	H	art.
14	54/72/90/108	50	TEATRO25014
		75	TEATRO27514

P	L	H	art.
22	54/72/90/108	50	TEATRO25022
		75	TEATRO27522



P	L	H	art.
14	81/108/135/162	50	TEATRO35014
		75	TEATRO37514

P	L	H	art.
22	81/108/135/162	50	TEATRO35022
		75	TEATRO37522

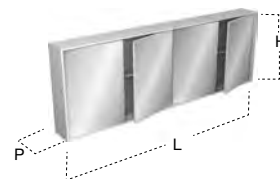

P	L	H	art.
14	108/144/180/216	50	TEATRO45014
		75	TEATRO47514

P	L	H	art.
22	108/144/180/216	50	TEATRO45022
		75	TEATRO47522

Versione sx / Left version

N.B. È possibile inserire 1 lampada a led superiore.

P.S. It is possible to insert 1 led light above.

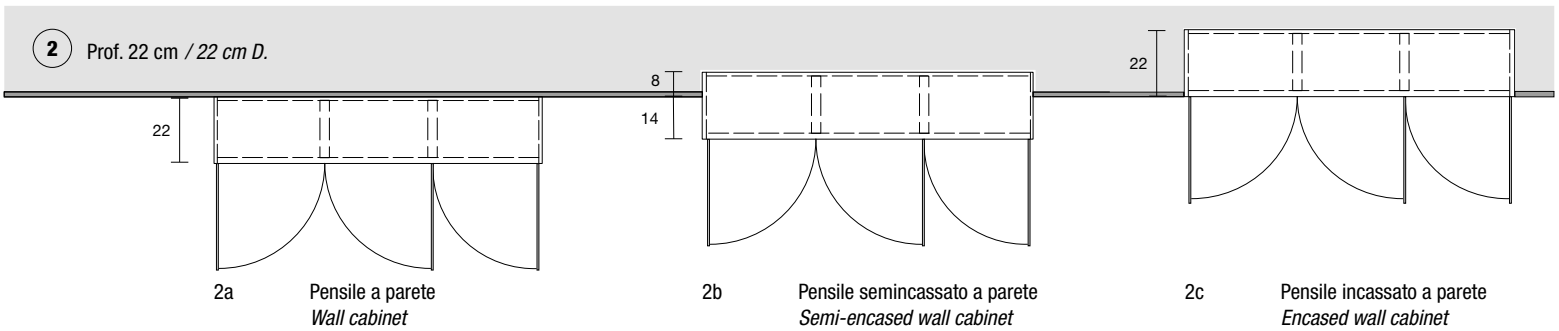
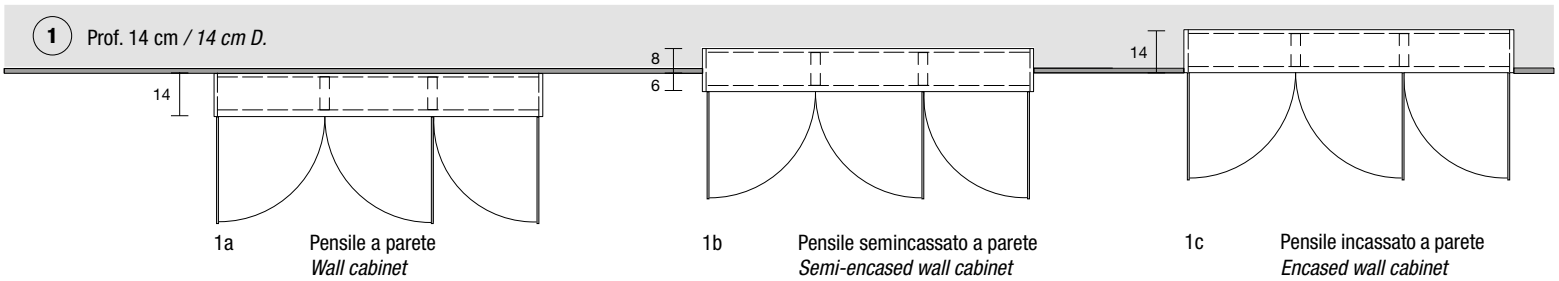

Pensile con anta a specchio bifacciale.

Wall cabinet with double face mirrored door.





su richiesta è possibile realizzare la mensola nella lunghezza desiderata.

*upon request it is possible to make the shelf in a customized length.*



OMBRA design Arkimera

Modello e design registrato, brevetto depositato  
*Registered model and design, patent filed*







OMBRA







# OMBRA

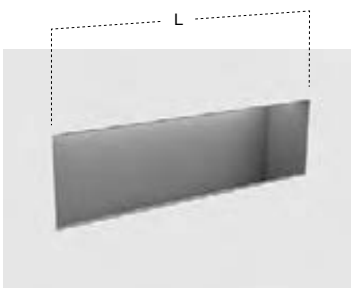
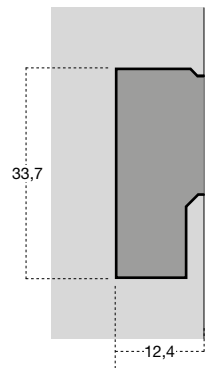

H	P	L	art.	art.
33,7	12,4	da / from 36 a / to 216	OMBRA	OMBRAL Con illuminazione a led / With led lighting

Mensola da incasso a parete con struttura in alluminio bianca o nera, con o senza illuminazione a led.

*Recessed wall shelf with white or black aluminum structure, with or without LED lighting.*



H	P	L	art.
10	12,8	27	OMBRAPS27
		36	OMBRAPS36
		54	OMBRAPS54

Porta salviette in alluminio bianco o nero per mensola Art. OMBRA e Art. OMBRAL.

*White or black aluminum towel holder for Art. OMBRA and Art. OMBRAL shelf.*

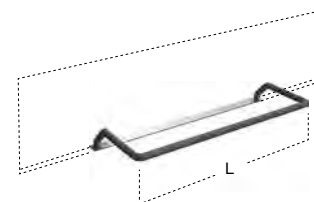

ICE Studio Carlesi Design

vetro bronzo con schienale verniciato ovatta opaco

*bronze glass with back panel lacquered matt ovatta*



vetro fumé con schienale verniciato creta opaco

fumé glass with back panel lacquered matt creta



Art. ICE4 / Art. ICE5 / Art. ICE6

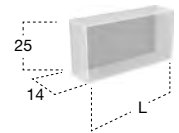

H	P	L	art.
25	14	27	ICE4
25	14	45	ICE5
25	14	72	ICE6

H	P	L	art.
50	14	27	ICE7
75	14	27	ICE8
100	14	27	ICE1
125	14	27	ICE2
150	14	27	ICE3

Pensili e colonne a giorno in cristallo extrachiaro, cristallo bronzo o fumé a 1, 2, 3, 4, 5 e 6 vani con schienale verniciato come da nostra cartella colori laccati.

Open wall cabinets in extra-clear glass, bronze or fume glass with 1, 2, 3, 4, 5 and 6 compartments and back panel lacquered as per our colour chart.

Art. ICE7

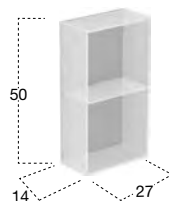

Art. ICE8

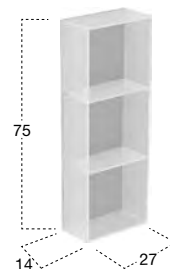

Art. ICE1

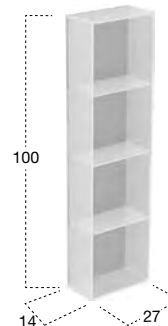

Art. ICE2

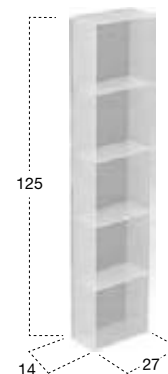

Art. ICE3

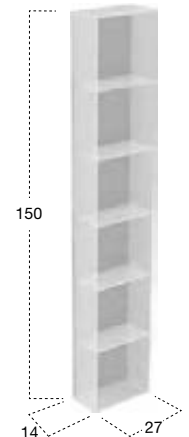



**TABULA** design Mario Ferrarini

Modello e design registrato, brevetto depositato  
*Registered model and design, patent pending*







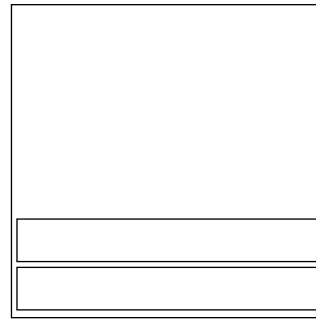

art.TAB1127 cm 27x27x1,2

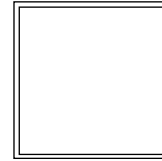

art.TAB213 cm 13,5x13,5x1,2



art.TAB209 cm 9x9x1,2

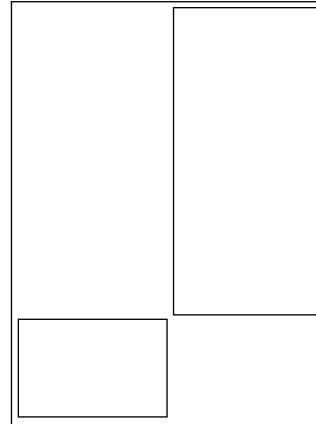
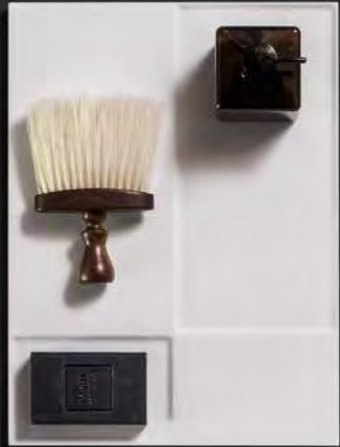

art.TAB3136 cm 27x36x1,2

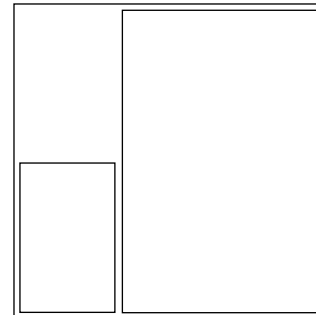

art.TAB4127 cm 27x27x1,2

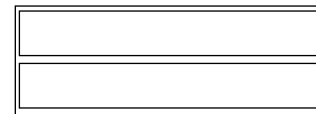

art.TAB5109 cm 27x9x1,2



art.TAB6109 cm 27x9x1,2

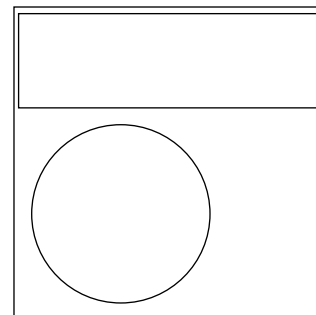

art.TAB7127 cm 27x27x1,2

SESAMO design Arkimera

Modello e design registrato, brevetto depositato  
Registered model and design, patent filed







- 1 SESAM05 Porta carta igienica con scorta / *Toilet paper holder with spare*
- 2 SESAM04 Porta carta igienica / *Toilet paper holder*
- 3 SESAM06 Porta scopino / *Toilet brush holder*
- 4 SESAM07 Cestino rifiuti / *Waste basket*
- 5 SESAM02 Porta dispenser/spazzolini / *Soap dispenser*
- 6 SESAM03 Porta dispenser doppio / *Double soap dispenser*
- 7 SESAM01 Appendi abiti / *Wall hook*

SESAMO

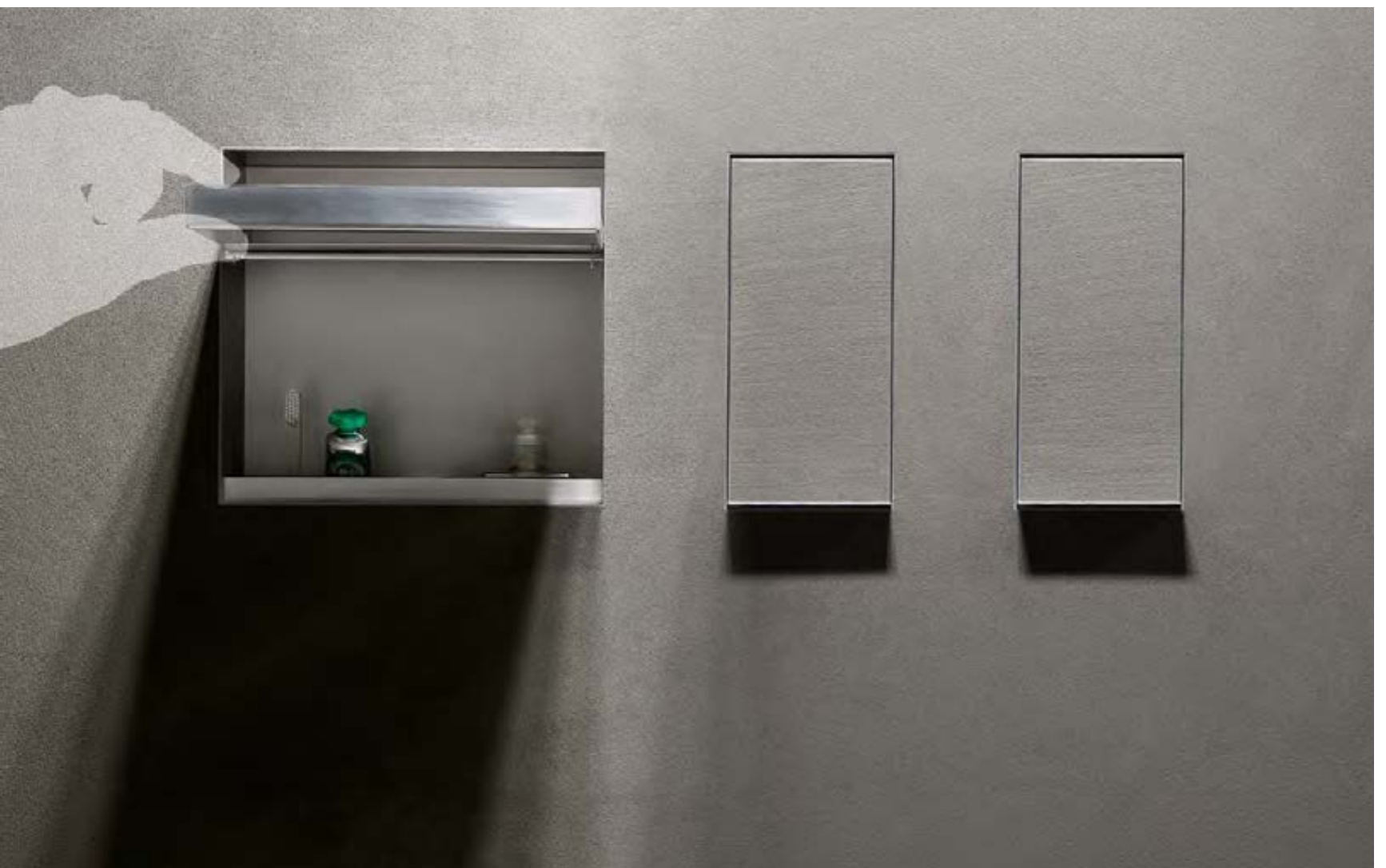



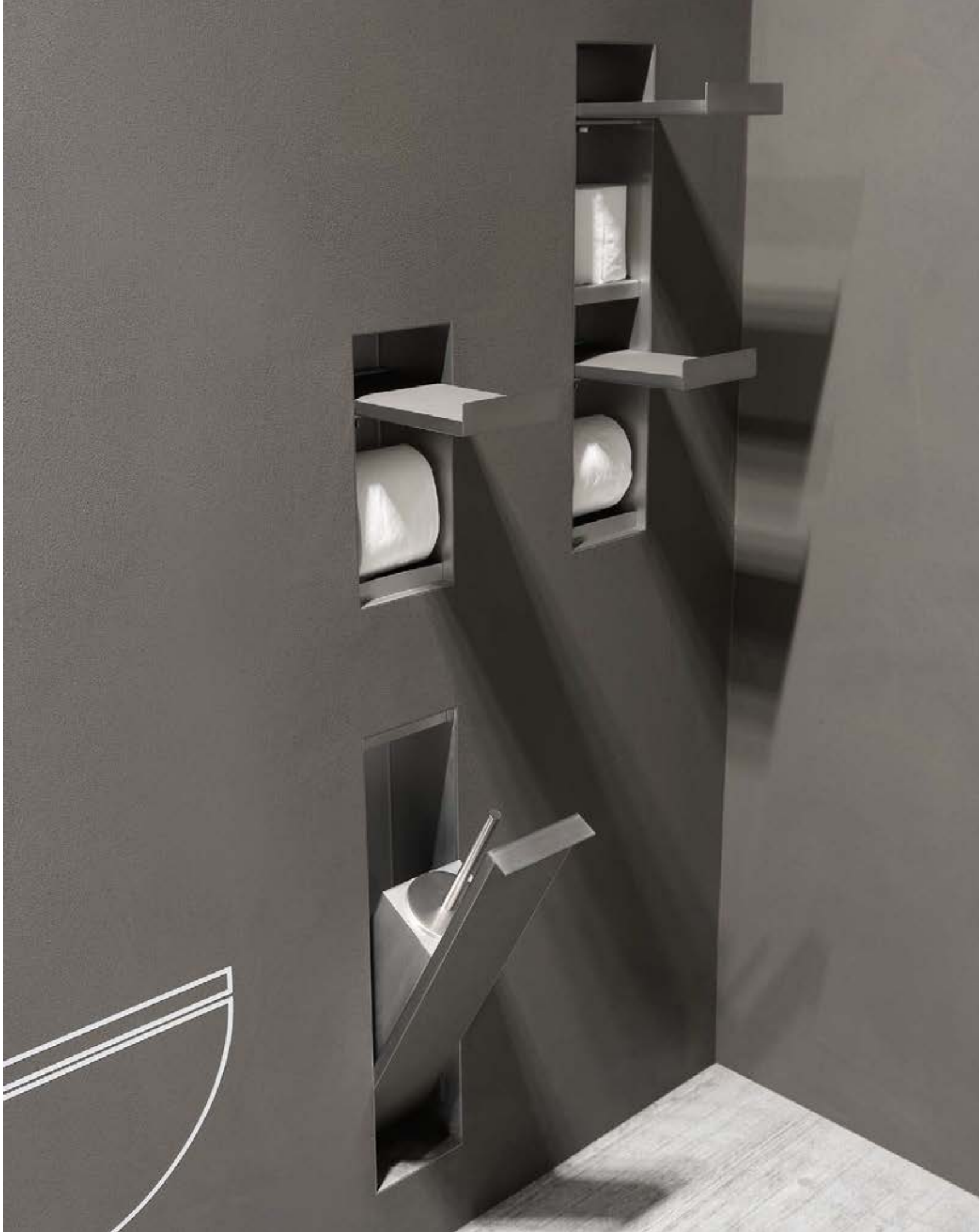

# SESAMO

Applicazione su cartongesso con finitura intonaco

*Application on drywall with plaster finishing*

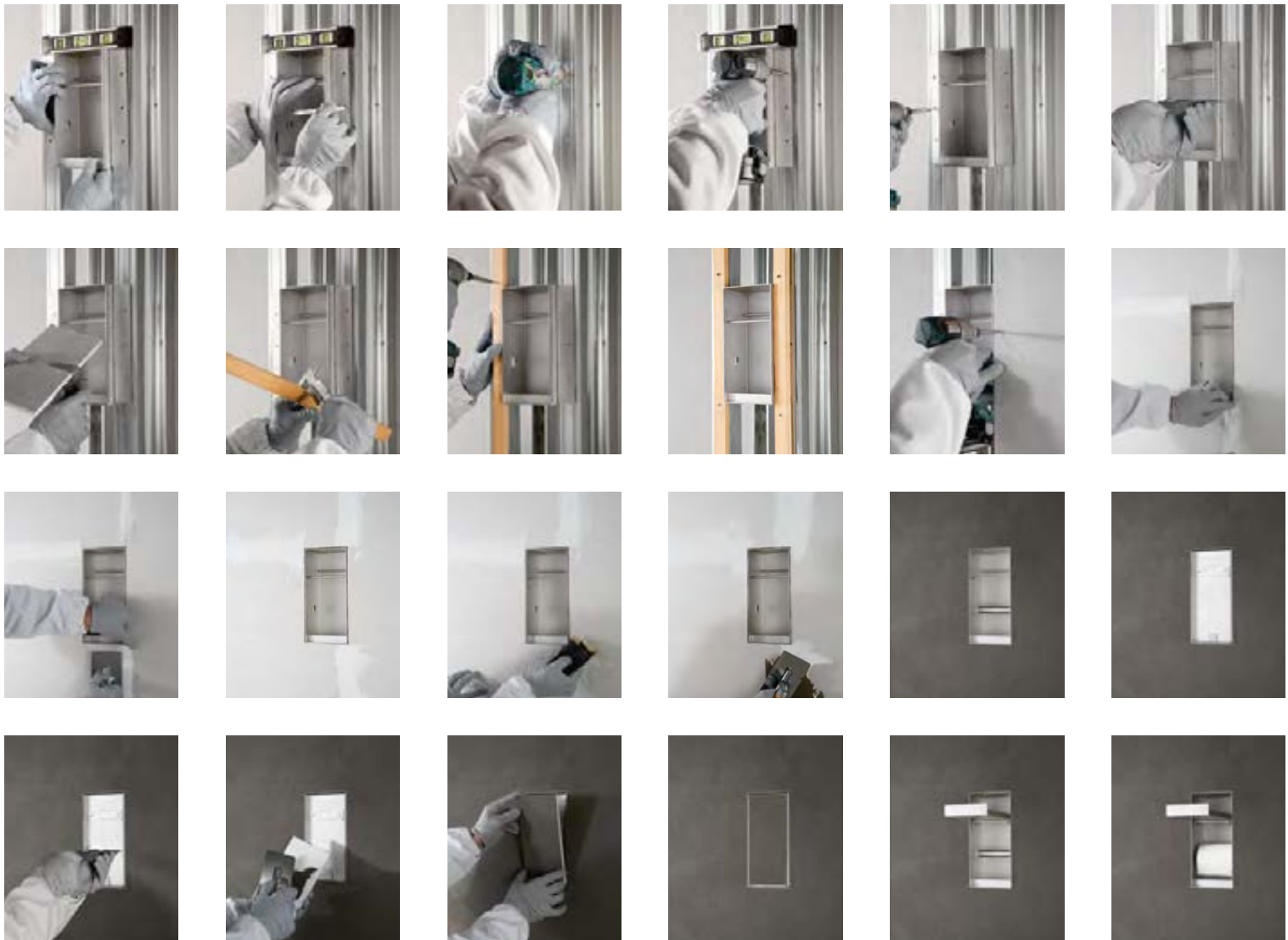

Applicazione su cartongesso con rivestimento marmo

*Application on drywall with marble covering*

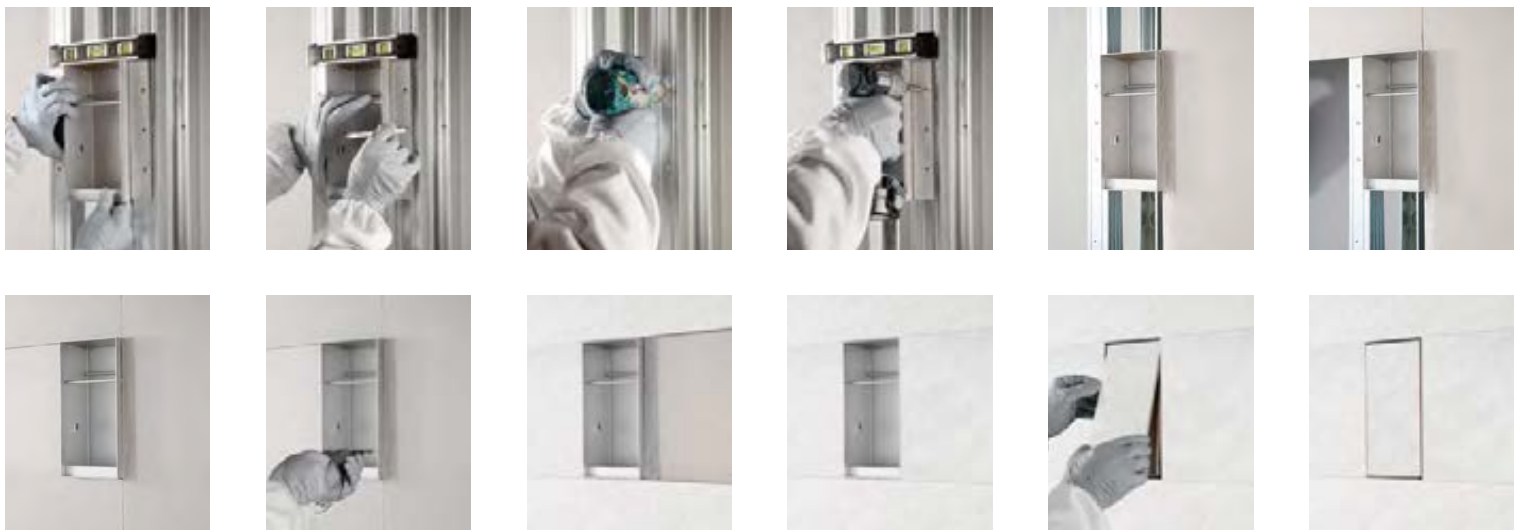

Appendi abiti da incasso a parete in acciaio inox AISI 304 finitura alluminio.

*Encased wall hook in stainless steel AISI 304 with an aluminum finish.*



H	P	L	art.
12,5	5,5	7,3	SESAM01

Porta dispenser o porta spazzolini da incasso a parete in acciaio inox AISI 304 finitura alluminio.

*Encased soap dispenser in stainless steel AISI 304 with an aluminum finish.*



H	P	L	art.
31,5	10,4	19,8	SESAM02

Porta scopino da incasso a parete in acciaio inox AISI 304 finitura alluminio.

*Encased toilet brush holder in stainless steel AISI 304 with an aluminum finish.*



H	P	L	art.
50	10,4	19,8	SESAM06

Porta carta con scorta da incasso a parete in acciaio inox AISI 304 finitura alluminio.

*Encased toilet paper holder and spare in stainless steel AISI 304 with an aluminum finish.*



H	P	L	art.
50	10,4	19,8	SESAM05

Porta carta da incasso a parete in acciaio inox AISI 304 finitura alluminio.

N.B. Lo spazio utile interno in profondità è di 8,7 cm per Art. SESAM04 e di 13,5 cm per Art. SESAM041.

*Encased toilet paper holder in stainless steel AISI 304 with an aluminum finish.*

*P.S. The internal useful space is 8,7 cm for Art. SESAM04 and is 13,5 cm for Art. SESAM041.*



H	P	L	art.
25	10,4	19,8	SESAM04
25	15	19,8	SESAM041

Porta dispenser o porta spazzolini doppio da incasso a parete in acciaio inox AISI 304 finitura alluminio.

*Encased double soap dispenser in stainless steel AISI 304 with an aluminum finish.*



H	P	L	art.
31,5	10,4	35	SESAM03

Cestino rifiuti da incasso a parete in acciaio inox AISI 304 finitura alluminio.

*Encased waste basket in stainless steel AISI 304 with an aluminum finish.*



H	P	L	art.
50	10,4	19,8	SESAM07



**TAPE** design Carlo Colombo

Tutta la serie TAPE é realizzata in acciaio inox satinato AISI 304.

*The TAPE series is produced in satin stainless steel AISI 304.*









# TAPE



Appendi abiti singolo a parete in acciaio inox satinato AISI 304.

*Satin stainless steel AISI 304 clothes hook.*

H	P	L	art.
6	8	8	TAPE106



Appendi abiti doppio a parete in acciaio inox satinato AISI 304.

*Double satin stainless steel AISI 304 clothes hook.*

H	P	L	art.
6	8	16	TAPE107



Dispenser sapone liquido da appoggio o da incasso per pianetti Corian in acciaio inox satinato AISI 304.

*Freestanding or encased soap dispenser in satin stainless steel AISI 304 for Corian surfaces.*

H	P	Ø	art.
16	9,5	6,5	TAPE101



Pianetto in Corian liscio.

*Corian surface.*

H	P	L	art.
1,2	8	13,5	TAPE1



Bicchiere da appoggio o da incasso per pianetti Corian in acciaio inox satinato AISI 304.

*Freestanding or encased cup in satin stainless steel AISI 304 for Corian surfaces.*

H	P	Ø	art.
10,5	6,5	6,5	TAPE102



Porta scopino da appoggio in resina bianca e manico in acciaio inox satinato AISI 304.

*Toilet brush and white resin holder with a satin stainless steel AISI 304 handle.*

H	P	Ø	art.
44	8	8	TAPE113

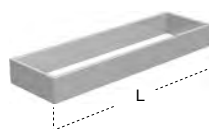

Porta salviette in acciaio inox satinato AISI 304.

*Satin stainless steel AISI 304 towel rack.*

H	P	L	art.
5	8	27	TAPE27
		36	TAPE36
		45	TAPE45
		54	TAPE54
		72	TAPE72



Pianetto in Corian liscio dx o sx reversibile, con portarotolo in acciaio inox satinato AISI 304.

*Corian surface right or left with satin stainless steel AISI 304 paper roll holder.*

H	P	L	art.
12	8	13,5	TAPE2



Porta sapone in Corian.

*Corian soap dish.*



Pianetto in Corian liscio.

*Corian surface.*



H	P	L	art.
1,2	8	13,5	TAPE3

Porta sapone in Corian dx o sx reversibile, con portarotolo in acciaio inox satinato AISI 304.

*Corian soap dish right or left with satin stainless steel AISI 304 paper roll holder.*



H	P	L	art.
1,2	8	27	TAPE11

Pianetto in Corian con foro per bicchiere o dispenser.

*Corian surface with hole for cup or dispenser.*



H	P	L	art.
12	8	13,5	TAPE4

Pianetto in Corian con foro per bicchiere o dispenser.

*Corian surface with hole for cup or dispenser.*



H	P	L	art.
1,2	8	27	TAPE12

Pianetto in Corian con 2 fori per bicchiere o dispenser.

*Corian surface with 2 holes for cup or dispenser.*



H	P	L	art.
1,2	8	13,5	TAPE5

Pianetto in Corian con griglia.

*Grided Corian surface.*



H	P	L	art.
1,2	8	27	TAPE13

Pianetto in Corian con griglia.

*Grided Corian surface.*



H	P	L	art.
1,2	8	13,5	TAPE6

H	P	L	art.
1,2	8	27	TAPE14

**PLAY** design AL Studio

Tutta la serie PLAY é realizzata in acciaio inox lucido AISI 304.

*The PLAY series is produced in polished stainless steel AISI 304.*





PLAY







PLAY





# PLAY

Appendi abiti singolo a parete in acciaio inox lucido AISI 304.

*Polished stainless steel AISI 304 clothes hook.*



H	P	L	art.
3	8	6	PLAY106

Appendi abiti doppio a parete in acciaio inox lucido AISI 304.

*Double polished stainless steel AISI 304 clothes hook.*



H	P	L	art.
3	8	12	PLAY107

Dispenser sapone liquido da appoggio o da incasso per pianetti Corian in acciaio inox lucido AISI 304.

*Freestanding or encased soap dispenser for Corian surfaces in polished stainless steel AISI 304.*



H	P	Ø	art.
16	9,5	6,5	PLAY101

Bicchiere da appoggio o da incasso per pianetti Corian in acciaio inox lucido AISI 304.

*Freestanding or encased cup for Corian surfaces in polished stainless steel AISI 304.*



H	P	Ø	art.
10,5	6,5	6,5	PLAY102

Porta scopino da appoggio in resina bianca e manico in acciaio inox lucido AISI 304.

*Toilet brush and white resin holder with a polished stainless steel AISI 304 handle.*



H	P	Ø	art.
44	8	8	PLAY113

Porta salviette in acciaio inox lucido AISI 304.

*Polished stainless steel AISI 304 towel rack.*

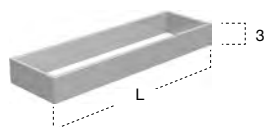

H	P	Ø	art.
3	8	27	PLAY27
		40	PLAY40
		54	PLAY54
		72	PLAY72

Pianetto in Corian liscio.

*Corian surface.*



H	P	L	art.
1,2	8	13,5	TAPE1

Pianetto in Corian liscio dx o sx reversibile, con portarotolo in acciaio inox lucido AISI 304.

*Corian surface with right or left polished stainless steel AISI 304 paper roll holder.*



H	P	L	art.
10	8	13,5	PLAY2

Porta sapone in Corian.

*Corian soap dish.*



H	P	L	art.
1,2	8	13,5	TAPE3

Porta sapone in Corian dx o sx reversibile, con portarotolo in acciaio inox lucido AISI 304.

*Corian soap dish with right or left polished stainless steel AISI 304 paper roll holder.*



H	P	L	art.
10	8	13,5	PLAY4

Pianetto in Corian con foro per bicchiere o dispenser.

*Corian surface with hole for cup or dispenser.*



H	P	L	art.
1,2	8	13,5	TAPE5

Pianetto in Corian con griglia.

*Gridded Corian surface.*



H	P	L	art.
1,2	8	13,5	TAPE6

Pianetto in Corian liscio.

*Corian surface.*



H	P	L	art.
1,2	8	27	TAPE11

Pianetto in Corian con foro per bicchiere o dispenser.

*Corian surface with hole for cup or dispenser.*



H	P	L	art.
1,2	8	27	TAPE12

Pianetto in Corian con 2 fori per bicchiere o dispenser.

*Corian surface with 2 holes for cup or dispenser.*



H	P	L	art.
1,2	8	27	TAPE13

Pianetto in Corian con griglia.

*Gridded Corian surface.*



H	P	L	art.
1,2	8	27	TAPE14

Bicchieri da appoggio in resina bianca.

*White resin cup.*



H	P	Ø	art.
12	8	8	JUST1

Porta sapone da appoggio in resina bianca.

*White resin soap dish.*



H	P	L	art.
3	8	12	JUST3

Dispenser sapone liquido da appoggio in resina bianca e acciaio inox lucido AISI 304.

*White and polished stainless steel AISI 304 resin soap dispenser.*



H	P	Ø	art.
19	11	8	PLAY6

Bicchieri in resina bianca con supporto a parete in acciaio inox lucido AISI 304.

*White resin cup with polished stainless steel AISI 304 wall support.*



H	P	Ø	art.
15	11,2	8	PLAY11

Dispenser sapone liquido in resina bianca con supporto a parete in acciaio inox lucido AISI 304.

*White resin soap dispenser with polished stainless steel AISI 304 wall support.*



H	P	Ø	art.
22	14,2	8	PLAY14

Piantana porta carta, porta salviette doppio in acciaio inox lucido AISI 304 con porta scopino in resina bianca.

*Freestanding polished stainless steel AISI 304 double paper roll or towel rack with white resin toilet brush and holder.*



H	P	L	art.
60	21,5	33	PLAY136







Porta salviette in alluminio verniciato bianco, nero opaco o colorato gofrato come da nostra cartella colori laccati.

*Towel holder in aluminium lacquered matt white, black or embossed as per our colour chart.*

H	P	L	art.
8	5	54	RETTA454
		72	RETTA472
		90	RETTA490
		108	RETTA4108

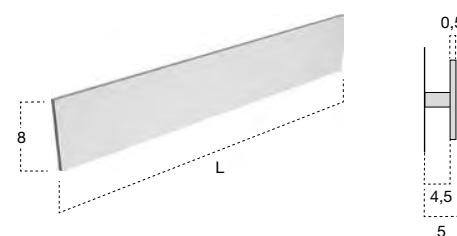

Porta salviette in alluminio verniciato bianco, nero opaco o colorato gofrato come da nostra cartella colori laccati.

*Towel holder in aluminium lacquered matt white, black or embossed as per our colour chart.*

H	P	L	art.
8	13	54	RETTA1254
		72	RETTA1272
		90	RETTA1290
		108	RETTA12108

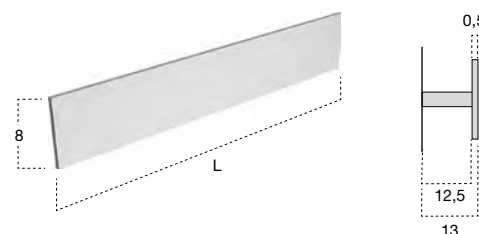

**JUST** design AL Studio

Tutta la serie JUST é realizzata in acciaio inox satinato AISI 304.

*The JUST series is produced in satin stainless steel AISI 304.*

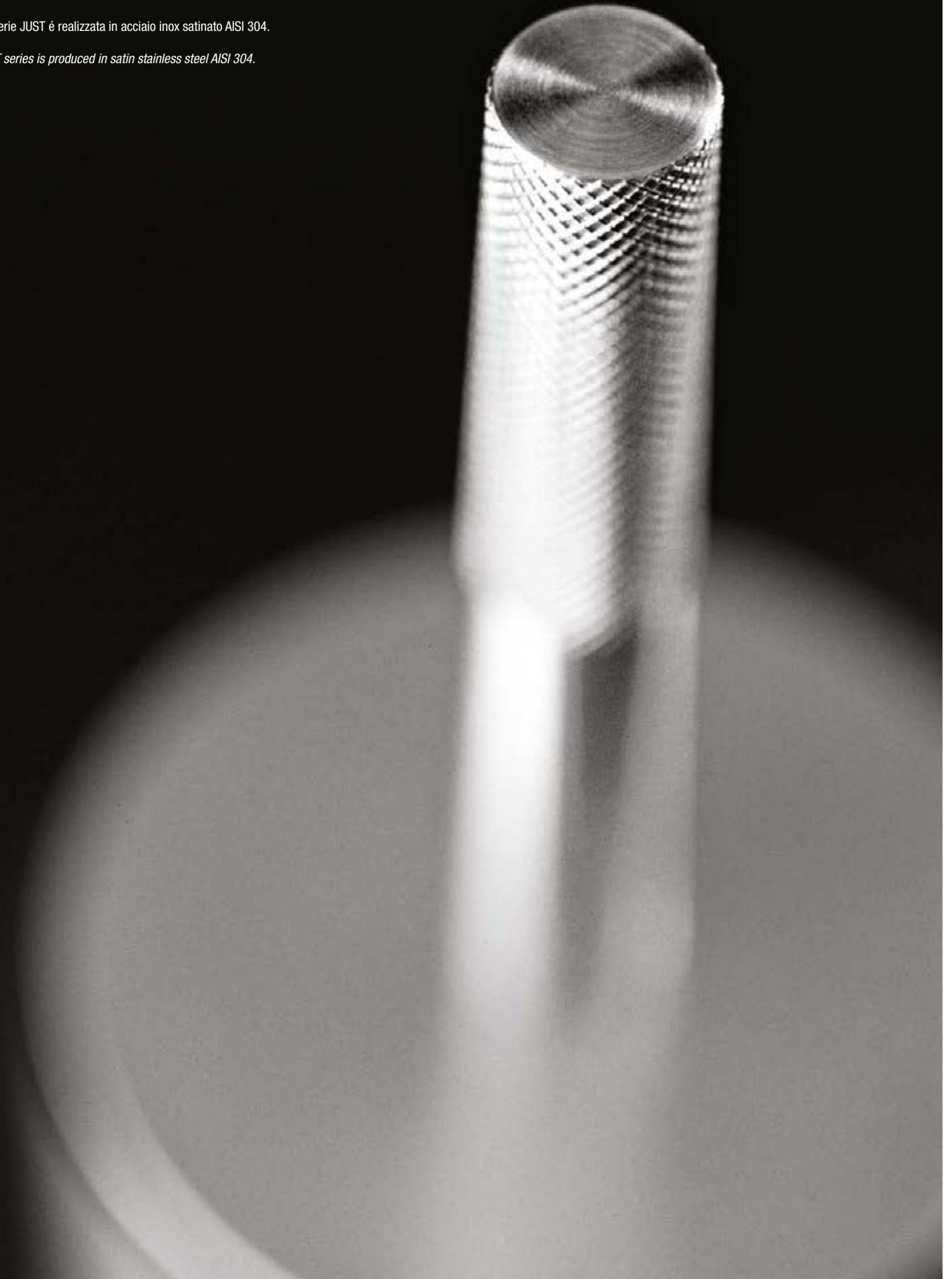

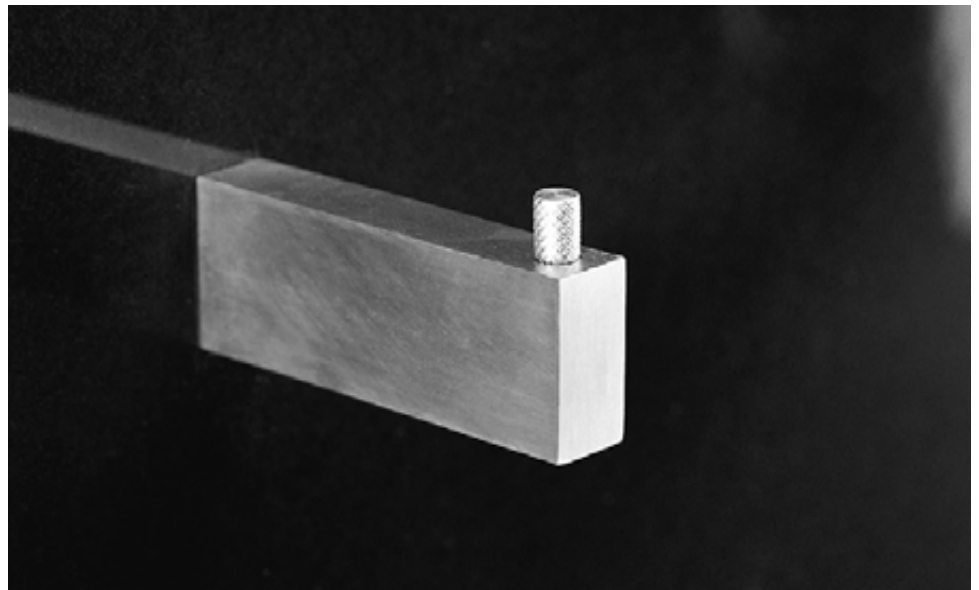
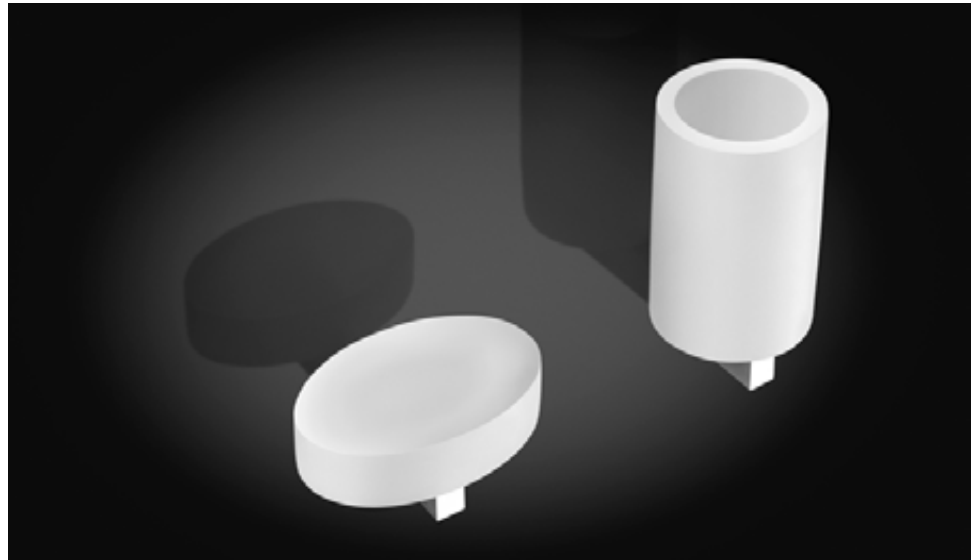



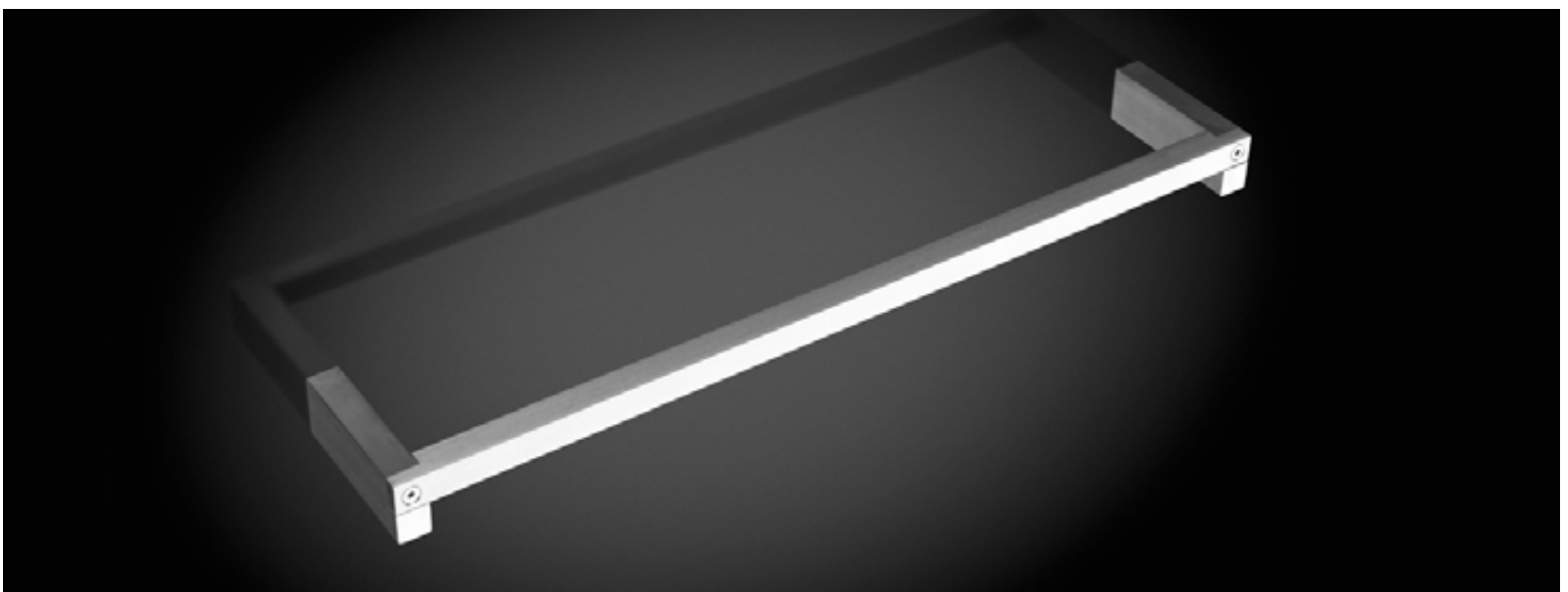
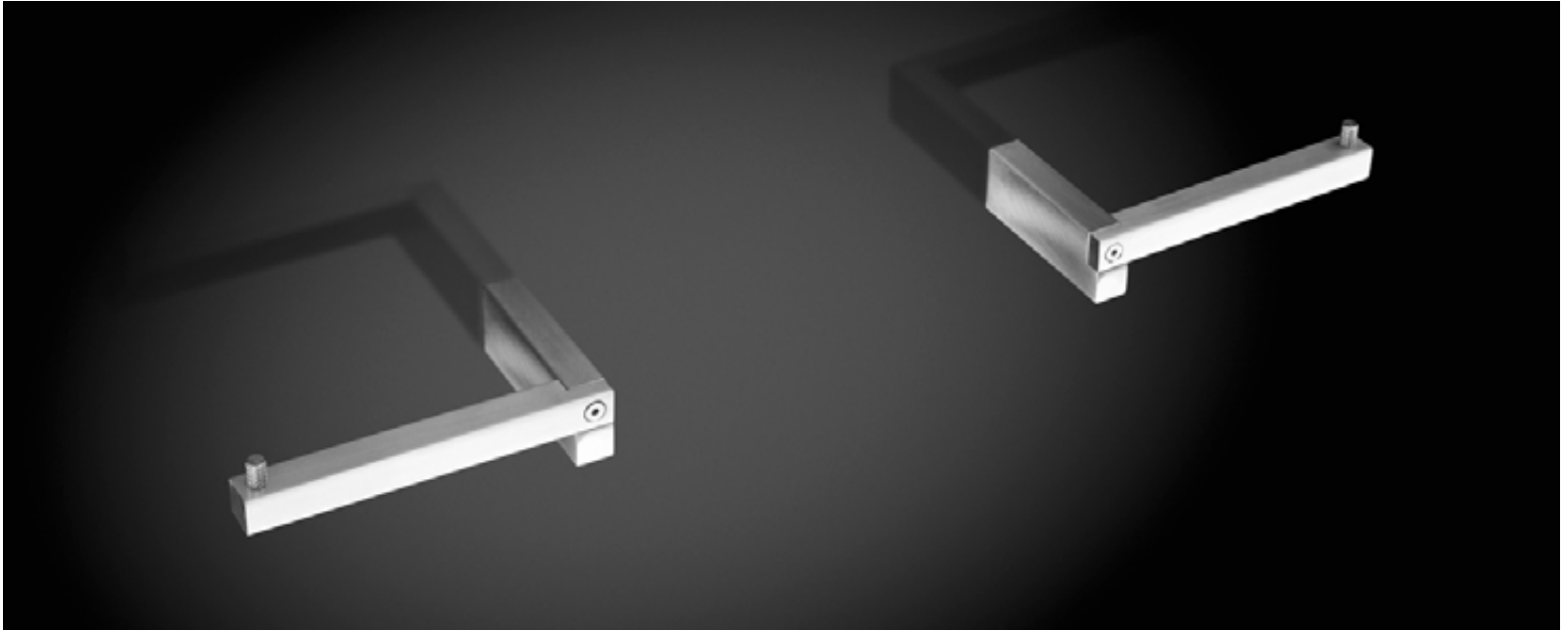





Bicchiere da appoggio in resina bianca.

*White resin cup.*



H	P	Ø	art.
12	8	8	JUST1

Porta sapone da appoggio in resina bianca.

*White resin soap dish.*



H	P	L	art.
3	8	12	JUST3

Dispenser sapone liquido da appoggio in resina bianca e acciaio inox satinato AISI 304.

*White resin and satin stainless steel AISI 304 soap dispenser.*



H	P	Ø	art.
19	11	8	JUST4

Porta scopino da appoggio in resina bianca e manico in acciaio inox satinato AISI 304.

*White resin and satin stainless steel AISI 304 toilet brush and holder.*



H	P	Ø	art.
44	8	8	JUST6

Bicchiere in resina bianca con supporto a parete in acciaio inox satinato AISI 304.

*White resin cup with satin stainless steel AISI 304 wall support.*



H	P	Ø	art.
15	11,2	8	JUST11

Dispenser sapone liquido in resina bianca con supporto a parete in acciaio inox satinato AISI 304.

*White resin soap dispenser with satin stainless steel AISI 304 wall support.*



H	P	Ø	art.
22	14,2	8	JUST14

Porta carta o porta salviette a parete, dx o sx reversibile, in acciaio inox satinato AISI 304.

*Satin stainless steel AISI 304 right or left wall mount paper roll holder.*



H	P	L	art.
3	8	14	JUST8

Appendi abiti a parete in acciaio inox satinato AISI 304.

*Satin stainless steel AISI 304 clothes hook.*



H	P	L	art.
3	8	1,5	JUST7

Porta salviette a parete in acciaio inox satinato AISI 304.

*Satin stainless steel AISI 304 wall mount towel rack.*

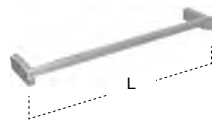

H	P	L	art.
3	8	45	JUST9
		60	JUST19

Piantana porta carta, porta salviette doppio in acciaio inox satinato AISI 304 con porta scopino in resina bianca.

*Freestanding satin stainless steel AISI 304 double paper roll or towel rack with white resin toilet brush and holder.*



H	P	L	art.
60	21,5	33	JUST106

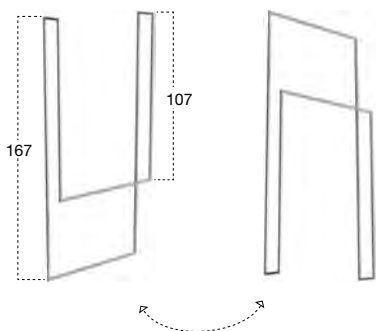

H	P	L	art.
167	15	72	TANDEM-UP

Porta salviette doppio da terra o da soffitto con struttura tubolare 15 x 15 mm in acciaio inox satinato AISI 304.

*Double towel rack freestanding or hanging with 15 x 15 mm satin stainless steel AISI 304 tubular structure.*

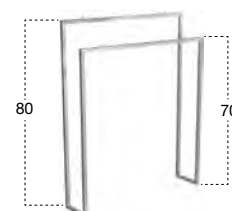

H	P	L	art.
80	15	54	TANDEMSA
80	15	54	TANDEMLU

Porta salviette doppio da terra con struttura tubolare 15 x 15 mm in acciaio inox AISI 304 satinato o lucido.

*Double freestanding towel rack with 15 x 15 mm satin or polished stainless steel AISI 304 tubular structure.*

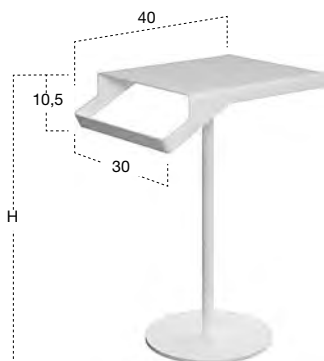

H	P	L	art.
65	40	30	GIN01
75	40	30	GIN02

Tavolino porta oggetti con porta salviette, in acciaio inox AISI 304 verniciato bianco, nero opaco o colorato gofrato come da nostra cartella colori laccati.

*Stainless steel AISI 304 table with towel rail lacquered matt white, black or embossed as per our colour chart.*





H	Ø	art.
68,5	36	LIN01
78,5	36	LIN02

Tavolino porta oggetti con piano in Cristalplant e piedistallo in acciaio inox AISI 304 verniciato bianco o colorato goffrato come da nostra cartella colori laccati.

*Table for objects with a Cristalplant surface and stainless steel AISI 304 base lacquered matt white or embossed as per our colour chart.*



H	L	art.
8,3	2,5	BILLO

Appendi abiti singolo in acciaio inox satinato AISI 304 per vetri box doccia.

*Single clothes hook in satin stainless steel AISI 304 suitable for shower enclosures.*



H	P	L	art.
4,6	32	36	TAO

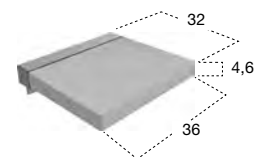

Seggetta reclinabile con fissaggio a parete in acciaio inox lucido AISI 304 e seduta di colore bianco in poliuretano morbido.

*Reclinable white soft polyurethane seat with polished stainless steel AISI 304 wall supports.*

Articoli venduti con lampade di classe energetica C e compatibili con lampade di classe energetica C e D

*Articles sold with bulbs of energy class C and compatible with bulbs of energy classes C and D*

LIGHT1  
LIGHT2  
RAGGIO

Articoli muniti di lampade a led integrate di classe energetica A non sostituibili

*Articles provided with integrated led bulbs of energy class A not replaceable*

APICE50W	FLASH75W	MODULO872W	NTKIT210W72	SPIO775W	VARIO75W
BATTIGIAL	FLASH90W	MODULO890W	NTKIT210W90	STRAPPOL	VARIO90W
BATTIGIAML	FLASH100W	MODULO8108W	OMBRAL	STRAPPOXLL	VARIO100W
BOLLA	FUORIMETE010	NEULUCE1	PERIPLO	TEATRO15014	VARIO110W
BOLLA2	FUORIMETE020	NEUTRO210W54	SEGRETO	TEATRO15022	VERTICE75W
BSK50W	FUORIMETE020C	NEUTRO210W72	SFOGLIA250	TEATRO25014	VERTICE90W
BSK75W	INTRECCIOL	NEUTRO210W90	SFOGLIA275	TEATRO25022	
BSK90W	LUMEN	NEUTRO1144W45	SFOGLIA290	TEATRO35014	
BSK100W	MANTRA150	NEUTRO1180W45	SFOGLIA2108	TEATRO35022	
BSK110W	MANTRA175	NEUTROLED50W	SFOGLIA75L	TEATRO45014	
BSK210W54	MANTRA190	NEUTROLED75W	SILENZIOL	TEATRO45022	
BSK210W72	MANTRA250	NEUTROLED90W	SOFFIOL	TEATRO17514	
BSK210W90	MANTRA275	NEUTROLED100W	SPIO1W	TEATRO17522	
CALICEL	MANTRA290	NEUTROLED110W	SPIO2W	TEATRO27514	
CIRCUS72W	METE01	NEUTROLED125W	SPIO3W	TEATRO27522	
CIRCUS90W	METE02	NEUTROLED142W	SPIO4W	TEATRO37514	
CIRCUS108W	METE02C	NTKIT50W	SPIO5W	TEATRO37522	
CIRCUS120W	METE03C	NTKIT75W	SPIO150W	TEATRO47514	
CIRCUS140W	METE0_INL	NTKIT90W	SPIO175W	TEATRO47522	
CIRCUS190W	METE0_OUTL	NTKIT100W	SPIO250W	TEATRO10014	
CIRCUS1108W	METE0XLL	NTKIT110W	SPIO275W	TEATRO10022	
FILA75W	MODULO672W	NTKIT125W	SPIO650W	TEATRO12514	
FILA90W	MODULO690W	NTKIT142W	SPIO675W	TEATRO12522	
FLASH50W	MODULO6108W	NTKIT210W54	SPIO750W	VARIO50W	

Articoli venduti con lampade di classe energetica A e compatibili con lampade di classe energetica A++, A+ e A

*Articles sold with bulbs of energy class A and compatible with bulbs of energy classes A++, A+ and A*

CURVA\_DOWN  
RONDÓ1

Articoli venduti con lampade di classe energetica A e compatibili con lampade di classe energetica A, B, C, D, E

*Articles sold with bulbs of energy class A and compatible with bulbs of energy classes A, B, C, D, E*

BOLLA1

Articoli muniti di lampade a led integrate di classe energetica A+ non sostituibili

*Articles provided with integrated led bulbs of energy class A+ not replaceable*

IRIDE  
LUCENTE45  
LUCENTE54  
LUCENTE63  
LUCENTE72  
LUCENTE81  
LUCENTE90  
LUCENTE99  
LUCENTE108  
LUCENTE117  
LUCENTE126  
LUCENTE135  
LUCENTE144  
LUCENTE153  
LUCENTE162  
LUCENTE171  
LUCENTE180  
LUCENTE189  
LUCENTE198  
LUCENTE207  
LUCENTE216  
ZENITLED

A photograph of a modern building's exterior at dusk. The sky is a mix of blue and pink. The building's facade is dark, and the name 'antoniolupi' is written in large, bold, lowercase letters that are illuminated from within, creating a bright white glow. To the left of the building, there are four small trees in white, rounded planters. The ground in front of the building is dark and appears to be a paved plaza.

**antoniolupi**



Dal 1950 una storia tutta italiana di ricerca, design, qualità e passione.

*Since 1950 an Italian story about research, design, quality and passion.*



L'azienda negli anni '60. *The company in the '60's.*



Antonio Lupi fotografato nel suo ufficio e mentre ritira un premio nel 1972. *Antonio Lupi photographed in his office and while receiving an award in 1972.*



L'argentatura degli specchi "alla vecchia maniera". *Applying the Silver coating "the old way".*



La foratura. *Drilling.*



La molatura. *Bevelling.*



Il reparto molatura. *The bevelling area.*



Il taglio. *The cut.*



**SPECCHI  
MIRRORS  
SPIEGELN  
MIROIRS**

**lupi**

**15**



Art. 1018 - kg. 8 - cm. diam. 68



Art. 515 - kg. 9,400 - cm. 63 x 78



Art. 3015 - kg. 9,600 - cm. 63 x 78

**lupi**

20

**DIVISIONE ESTERO - RAYON EXPORT - EXPORT DIVISION  
EXPORT-ABTEILUNG**







Uffici *Offices*





Ingresso *Entrance gate*



Vetreria *Glassworks*



Uffici progettazione *Project planning office*







Ogni mobile viene realizzato singolarmente da maestranze specializzate che ad esempio tagliano e assemblano le varie parti da un unico foglio di essenza, in modo che le venature corrispondano perfettamente.





8 strati di  
verniciatura  
*8 coats of  
paint*

1 polyester  
2 polyester  
3 vernice / paint  
4 vernice / paint

1 polyester  
2 polyester  
3 vernice / paint  
4 vernice / paint

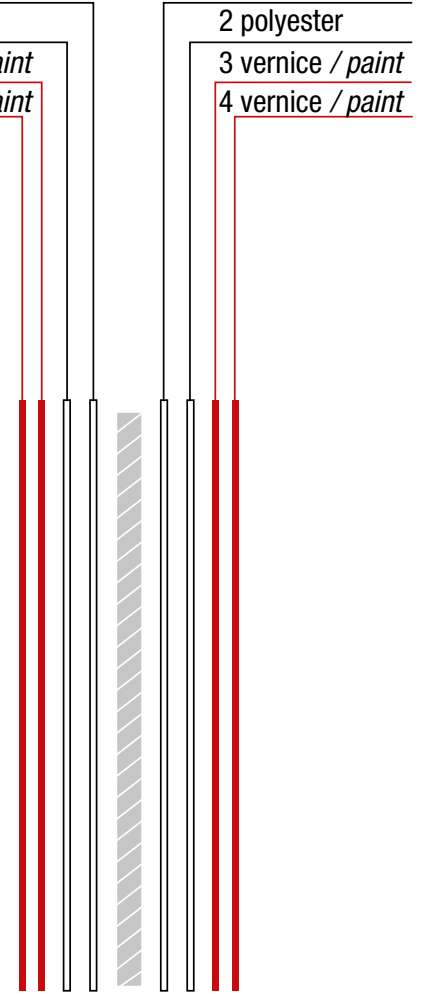





## CAMINI

La nostra azienda produce anche una vasta collezione di camini a legna e a bioetanolo, potete trovarli sul nostro sito e scaricare il catalogo nell'area download.

## FIREPLACES

*Our company also produces a large collection of wood burning and bioethanol fireplaces that you can find on our website and download the catalogue from the download area.*







## IGIGANTI design Carlo Colombo

I grandi vasi per esterni che vedete in questa immagine, fanno parte della collezione IGIGANTI, potete trovarli sul nostro sito e scaricare il catalogo nell'area download.

*The large outdoor vases that you see in this image are part of the IGIGANTI collection, that can be found on our website and you can download the catalogue from the download area.*







**antoniolupi**

**4**

**www.antoniolupi.it**

Per essere costantemente informati su novità e prodotti in modo dettagliato, vi invitiamo a navigare nel nostro sito sempre aggiornato. Nell'area download potrete scaricare tutto il materiale tecnico ed informativo che vi necessita.

*To constantly be up to date in a detailed manner on novelties and products please navigate through our website. In the download area you can find all the necessary technical information.*



Scarica l'App su iTunes e Google Play per entrare nel mondo antoniolupi

*Download the App on iTunes and Google Play to discover the world of antoniolupi*



Prodotto interamente in Italia.

*Entirely made in Italy.*

© Antonio Lupi Design S.p.A. 2018

NOTA: alla Antonio Lupi Design S.p.A. è riservata la facoltà di apportare ai propri modelli qualsiasi modifica estetica, tecnica, nelle dimensioni e nei colori, ritenuta necessaria, nonché la facoltà di sospendere la produzione in qualunque momento senza preavviso, rinunziata fin d'ora da parte del committente ogni conseguente richiesta risarcitoria. Si declina ogni responsabilità relativa ad eventuali inesattezze contenute in questo catalogo, se dovute ad errori di stampa o trascrizioni. Nessun contenuto di questo catalogo può essere copiato, riprodotto anche parzialmente, ripubblicato, trasmesso o distribuito in qualunque forma, senza autorizzazione scritta dell'Antonio Lupi Design S.p.a.

*NOTE: Antonio Lupi Design S.p.A. reserves the right to make any and all necessary esthetic, technical, colour or size modifications in order to enhance use and esthetic value, and may suspend the production cycle at any moment without notice. Such instances may not be subject to claim by the client. We decline all responsibilities for any possible uncertainties due to misprints in this catalogue. None of the material in this catalogue can be copied, reproduced, republished or distributed in any or partial way unless a written authorization is given from the company Antonio Lupi Design S.p.a.*





