

MI
SU
RA

by

SEGNO

CARTA
BIANCA

CERASA®

SISTEMA

L'INEDITO PROGETTO D'ARREDO CERASA DOVE TUTTO È POSSIBILE. È LA VISIONE DEL MOBILE DA BAGNO GLOBALE IN CUI L'ANTA ESPRIME TUTTE LE SUE CARATTERISTICHE FUNZIONALI ED ESTETICHE PER RIFLETTERE LA PERSONALITÀ DI CIASCUNO.

SISTEMA

THE NEW CERASA FURNISHING DESIGN, WHERE EVERYTHING IS POSSIBLE. THIS IS THE VISION TO FURNISH THE ENTIRE BATHROOM, IN WHICH THE DOOR EXPRESSES ALL ITS FUNCTIONAL AND AESTHETIC CHARACTERISTICS, TO REFLECT EACH ONE'S PERSONALITY.

SISTEMA

LE NOUVEAU PROJET D'AMEUBLEMENT CERASA OÙ TOUT EST POSSIBLE. C'EST UNE VISION DU MEUBLE DE SALLE DE BAIN GLOBALE, OÙ LA PORTE EXPRIME TOUTES SES CARACTÉRISTIQUES FONCTIONNELLES ET ESTHÉTIQUES POUR REFLÉTER LA PERSONNALITÉ DE CHACUN.

MISURA

MISURA RACCHIUDE UNA SERIE DI PROPOSTE PRECONFIGURATE RELATIVE ALLE COLLEZIONI CARTABIANCA E SEGNO, RISULTANDO COSÌ UN PROGRAMMA DI IMMEDIATA E FACILE CONSULTAZIONE. LE COMPOSIZIONI PRESENTI IN QUESTO CATALOGO SPAZIANO DA ELEMENTI LAVABO MONOBLOCCO A SITUAZIONI PRECONFIGURATE componibili. SI UTILIZZANO LAVABI DEDICATI CON MISURE PREDEFINITE.

COLONNE, MENSOLE, SPECCHI, LAMPADE ED ACCESSORI DELLE COLLEZIONI CARTABIANCA E SEGNO COMPLETANO LE PROPOSTE.

MISURA

MISURA PRESENTS A SERIES OF SELECTED COMPOSITIONS, REALISED WITH CARTABIANCA AND SEGNO COLLECTIONS, BECOMING A PROGRAMME EASY TO BE CONSULTED. THE COMPOSITIONS IN THIS CATALOGUE INCLUDE MONOBLOC WASHBASIN UNITS AND MODULAR COMPOSITIONS; COMPATIBLE BASINS, WITH SPECIFIC SIZES, ARE USED. FULL-HEIGHT UNITS, SHELVES, MIRRORS, LAMPS AND ACCESSORIES OF CARTABIANCA AND SEGNO COLLECTIONS COMPLETE THESE PROPOSALS.

MISURA

MISURA PRÉSENTE UNE SÉRIE DE COMPOSITIONS SÉLECTIONNÉES DES COLLECTIONS CARTABIANCA ET SEGNO, DEVENANT AINSI UN PROGRAMME DE FACILE CONSULTATION. LES COMPOSITIONS DANS CE CATALOGUE INCLUENT DES ÉLÉMENTS SOUS-VASQUE MONO-BLOQUES ET DES COMPOSITIONS MODULABLES ; DES VASQUES ASSORTIES, AVEC MESURES SPÉCIFIQUES, SONT UTILISÉES. COLONNES, ÉTAGÈRES, MIROIRS, LAMPES ET ACCESSOIRES DES COLLECTIONS CARTABIANCA ET SEGNO COMPLÈTENT CES PROPOSITIONS.

SISTEMA
MISURA
220
600
650
370
1200
450
550
850
1050
360
1400
950

CARTABIANCA

UNA COLLEZIONE DALLO STILE CONTEMPORANEO, CARATTERIZZATA DA UN'ESTREMA VERSATILITÀ. NUMEROSI ARTICOLI, DISPONIBILI IN MOLTEPLICI FINITURE E DIMENSIONI, DIVERSE MANIGLIE E LA POSSIBILITÀ DI OPTARE PER IL MECCANISMO PUSH-PULL, PERMETTONO DI CREARE SOLUZIONI UNICHE E PARTICOLARI IN OGNI DETTAGLIO. CON CARTABIANCA L'ESTETICA ABBRACCIA LA FUNZIONALITÀ.

CARTABIANCA

A COLLECTION IN A CONTEMPORARY STYLE, FEATURING EXTREME VERSATILITY. NUMEROUS ITEMS, AVAILABLE IN A MULTITUDE OF FINISHES AND SIZES, WITH DIFFERENT HANDLES OR THE OPTION OF THE PUSH-PULL MECHANISM, ALLOW UNIQUE SOLUTIONS TO BE CREATED - SPECIAL IN EVERY DETAIL. WITH CARTABIANCA, AESTHETICS EMBRACE FUNCTION.

CARTABIANCA

UNE COLLECTION AU STYLE CONTEMPORAIN, CARACTÉRISÉE PAR UNE EXTRÊME POLYVALENCE. BEAUCOUP D'ARTICLES, DISPONIBLES DANS NOMBREUSES FINITIONS ET MESURES, DIFFÉRENTES POIGNÉES ET AUSSI LA POSSIBILITÉ D'OPTER POUR LE MÉCANISME PUSH-PULL, PERMETTENT DE CRÉER DES SOLUTIONS UNIQUES ET SPÉCIALES DANS TOUS LES DÉTAILS. AVEC CARTABIANCA, L'ESTHÉTIQUE EMBRASSE LA FONCTIONNALITÉ.

SISTEMA

SEGNO

LA LINEA PULITA DI SEGNO SI MANIFESTA NELL'ASSENZA DELLA MANIGLIA, CHE RENDE LA COLLEZIONE MODERNA E CONTEMPORANEA. LA COMPONENTI INFINITA, ASSIEME ALLE MOLTEPLICI FINITURE, FANNO DI SEGNO UN MODELLO TRASVERSALE, ADATTO A OGNI TIPO DI AMBIENTE. UN SEGNO RICONOSCIBILE NELLA SUA SEMPLICITÀ CHE DONA ELEGANZA E RAFFINATEZZA.

SEGNO

THE CLEAN LINE OF SEGNO IS CHARACTERISED BY THE ABSENCE OF THE HANDLE, WHICH MAKES THE COLLECTION MODERN AND CONTEMPORARY. THE INFINITE MODULARITY, TOGETHER WITH THE WIDE VARIETY OF FINISHES, MAKES SEGNO A TRANSVERSAL MODEL, SUITABLE FOR EVERY TYPE OF ENVIRONMENT. A RECOGNISABLE SIGN IN ITS ELEGANT AND REFINED SIMPLICITY.

SEGNO

LA LIGNE ÉPURÉE DE SEGNO SE MANIFESTE PAR L'ABSENCE DE LA POIGNÉE, CE QUI REND LA COLLECTION MODERNE ET CONTEMPORAINE. LA MODULARITÉ INFINIE, AINSI QUE LES MULTIPLES FINITIONS, FONT DE SEGNO UN MODÈLE TRANSVERSAL, ADAPTÉ À TOUT TYPE D'ENVIRONNEMENT. UN SIGNE RECONNAISSABLE DANS SA SEMPLICITÉ ÉLÉGANTE ET RAFFINÉE.

MI
SU
RA
by

SEGNO
CARTA
BIANCA

1200

1.
FINITURE: NOBILITATO
COSMOPOLITAN/NOBILITATO GRIGIO FUMO.
LAVABO: GLOBAL SX.

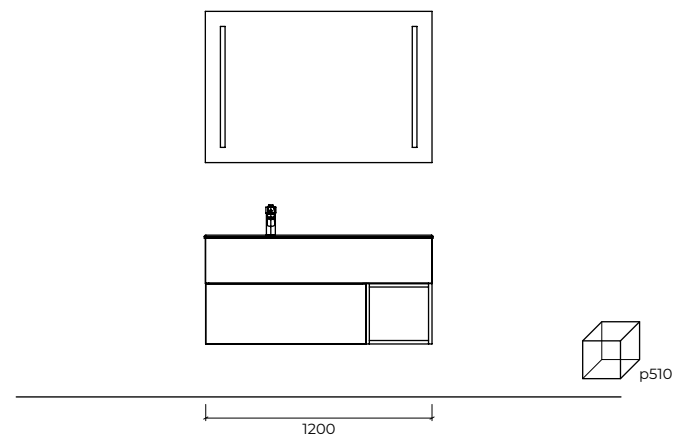

FINISHES: COSMOPOLITAN
LAMINATE/GRIGIO FUMO LAMINATE.
INTEGRAL BASIN: GLOBAL SX.

FINITIONS: STRATIFIÉ
COSMOPOLITAN/STRATIFIÉ GRIGIO FUMO.
PLAN-VASQUE: GLOBAL SX.



510

SI
STE
MA



510

455
1200
360

2.
FINITURA: NOBILITATO GRIGIO DORIAN.
LAVABO: UNICA.

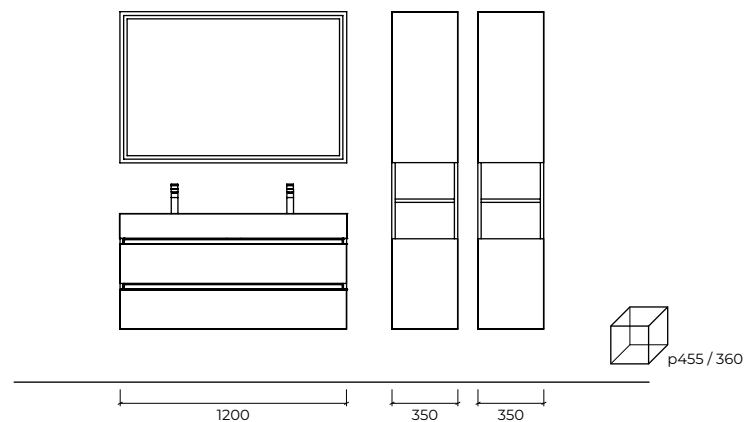

FINISH: GRIGIO DORIAN LAMINATE.
INTEGRAL BASIN: UNICA.

FINITION: STRATIFIÉ GRIGIO DORIAN.
PLAN-VASQUE: UNICA.





CONSOLLE **UNICA** 120 CM PER SINGOLO,
O DOPPIO RUBINETTO.

UNICA INTEGRAL BASIN W.120 CM AVAILABLE
FOR SINGLE OR DOUBLE MIXER.

PLAN-VASQUE **UNICA** L.120 CM DISPONIBLE
POUR MITIGEUR UNIQUE OU DOUBLE.



510
1200
220

3.
FINITURE: NOBILITATO
INTRECCIO/NOBILITATO WHITE.
LAVABO: WINGS SX.

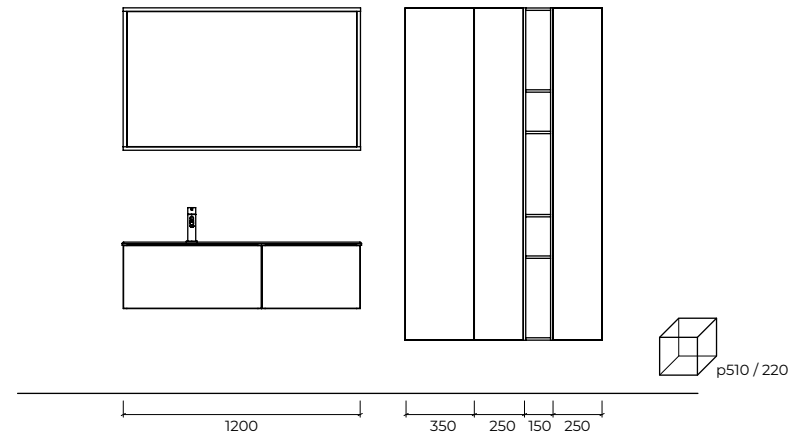

FINISHES: INTRECCIO
LAMINATE/WHITE LAMINATE.
INTEGRAL BASIN: WINGS SX.

FINITIONS: STRATIFIÉ
INTRECCIO/STRATIFIÉ WHITE.
PLAN-VASQUE: WINGS SX.





4.
FINITURE: LACCATO LUCIDO RAL 7002/
NOBILITATO EFFETTO MALTA COLORE CRETA.
LAVABO: GLOBAL 2.

FINISHES: GLOSSY RAL 7002 LACQUERED/
EFFETTO MALTA COLOUR CRETA LAMINATE.
INTEGRAL BASIN: GLOBAL 2.

FINITIONS: LAQUÉ RAL 7002 BRILLANT/
STRATIFIÉ EFFET MALTA COULEUR CRETA.
PLAN-VASQUE: GLOBAL 2.

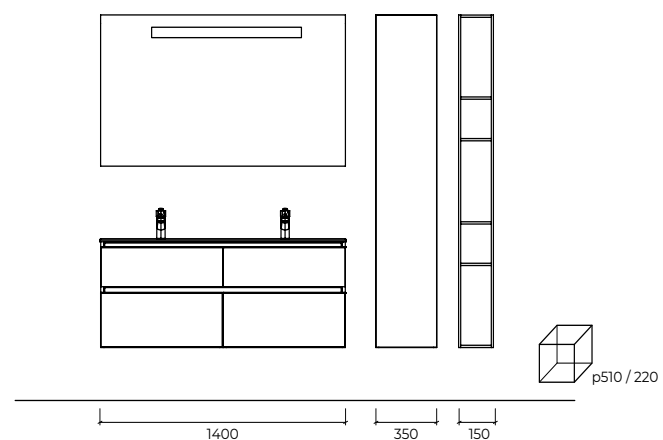

510
2201400
0071022

I LAVABI **GLOBAL** E **WINGS** SONO DISPONIBILI
ANCHE CON DOPPIA VASCA.

GLOBAL AND **WINGS** INTEGRAL BASINS ARE
AVAILABLE ALSO WITH DOUBLE BASIN.

LES PLANS-VASQUE **GLOBAL** ET **WINGS** SONT
DISPONIBLES AUSSI AVEC DOUBLE VASQUE.



5.
FINITURA: NOBILITATO MOKA.
LAVABO: UNICA.

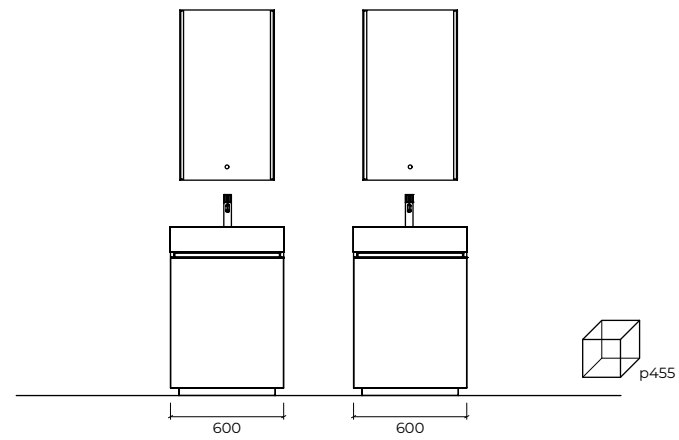

FINISH: MOKA LAMINATE.
INTEGRAL BASIN: UNICA.

FINITION: STRATIFIÉ MOKA.
PLAN-VASQUE: UNICA.

455



BASE LAVABO DA 60 CM DISPONIBILE
CON ANTA O CON CASSETTONE.

WASHBASIN UNIT W.60 CM AVAILABLE WITH
DOOR OR DRAWER.

ÉLÉMENT SOUS-VASQUE L.60 CM DISPONIBILE
AVEC PORTE OU AVEC TIROIR.



6.
FINITURE: NOBILITATO
TABACCO/LACCATO BIANCO OPACO.
LAVABO: GLOBAL 1.

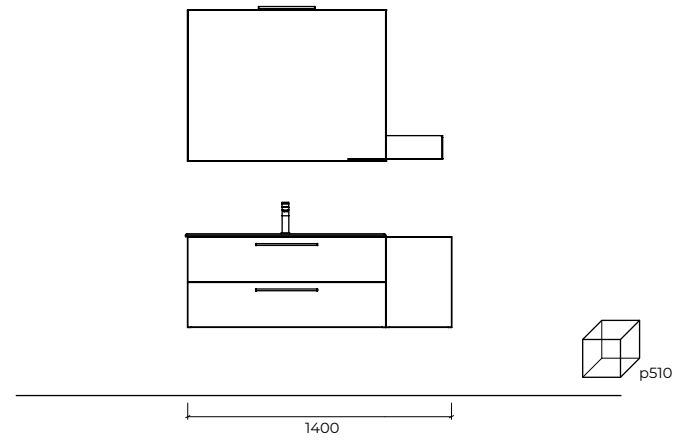

FINISHES: TABACCO
LAMINATE/MATT BIANCO LACQUERED.
INTEGRAL BASIN: GLOBAL 1.

FINITIONS: STRATIFIÉ
TABACCO/LAQUÉ BIANCO MAT.
PLAN-VASQUE: GLOBAL 1.

510
1400



140051n



MENSOLA IN METALLO LACCATA OPACA.

MATT LACQUERED METAL SHELF.

ÉTAGÈRE EN MÉTAL LAQUÉ MAT.







537



220
950
350

7.
FINITURE: LACCATO BIANCO
LUCIDO/NOBILITATO INTRECCIO.
LAVABO: ONDA 95.

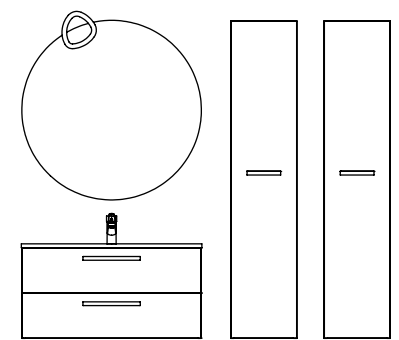

p537 / 220

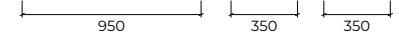

FINISHES: GLOSSY BIANCO
LACQUERED/INTRECCIO LAMINATE.
INTEGRAL BASIN: ONDA 95.

FINITIONS: LAQUÉ BIANCO
BRILLANT/STRATIFIÉ INTRECCIO.
PLAN-VASQUE: ONDA 95.



8.
FINITURE: NOBILITATO GRIGIO
MINERALE/NOBILITATO GRIGIO FUMO.
LAVABO: UNICA.

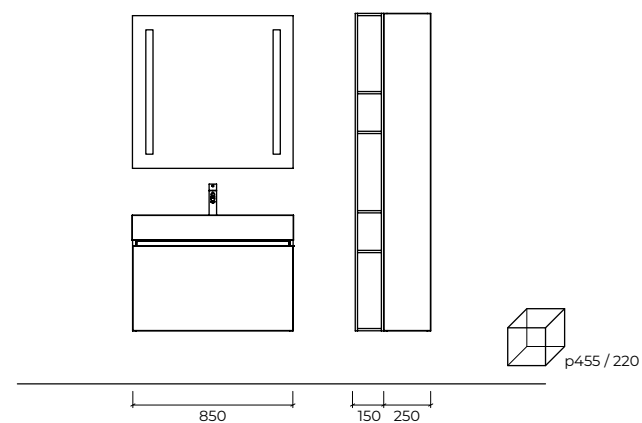

FINISHES: GRIGIO MINERALE
LAMINATE/GRIGIO FUMO LAMINATE.
INTEGRAL BASIN: UNICA.

FINITIONS: STRATIFIÉ GRIGIO
MINERALE/STRATIFIÉ GRIGIO FUMO.
PLAN-VASQUE: UNICA.





9.
FINITURA: NOBILITATO FUSION.
LAVABO: WINGS DX.

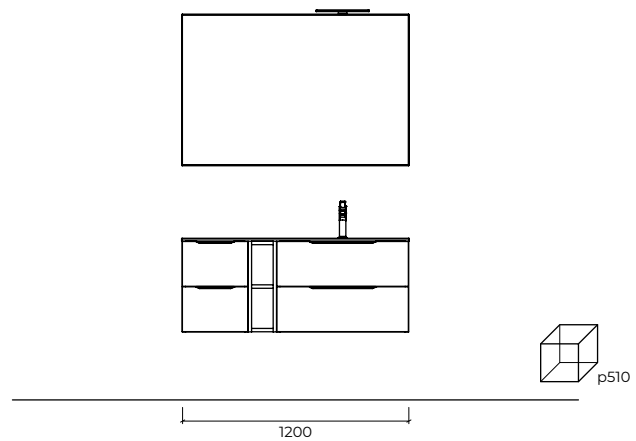

FINISH: FUSION LAMINATE.
INTEGRAL BASIN: WINGS DX.

FINITION: STRATIFIÉ FUSION.
PLAN-VASQUE: WINGS DX.



120510

10.
 FINITURE: NOBILITATO SABBIA/
 NOBILITATO EUCALIPTO.
 LAVABO: GLOBAL SX.

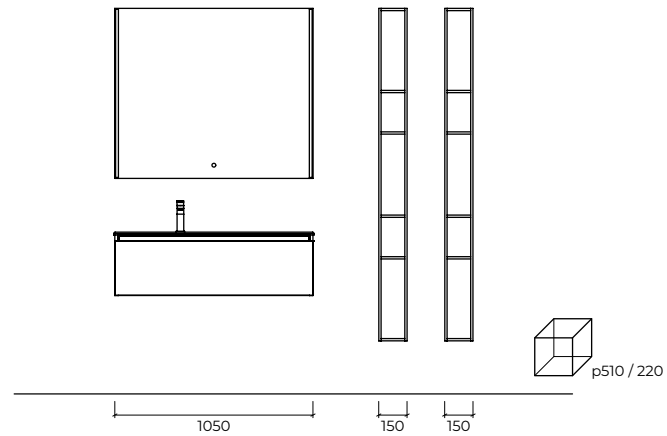

FINISHES: SABBIA LAMINATE/
 EUCALIPTO LAMINATE.
 INTEGRAL BASIN: GLOBAL SX.

FINITIONS: STRATIFIÉ SABBIA/
 STRATIFIÉ EUCALIPTO.
 PLAN-VASQUE: GLOBAL SX.



510 1050

220

11.
FINITURA: NOBILITATO COSMOPOLITAN.
LAVABO: UNICA.

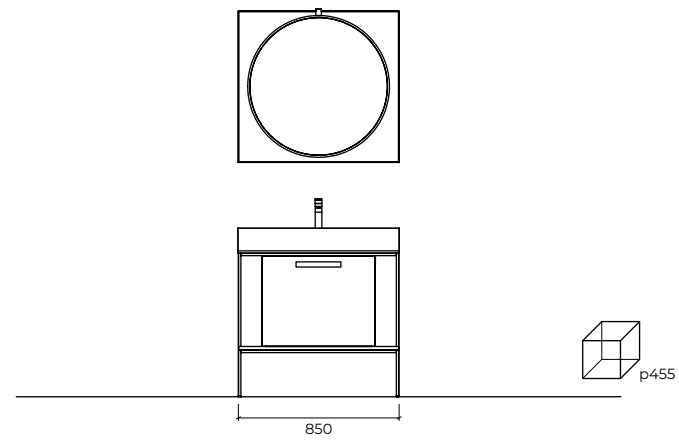

FINISH: COSMOPOLITAN LAMINATE.
INTEGRAL BASIN: UNICA.

FINITION: STRATIFIÉ COSMOPOLITAN.
PLAN-VASQUE: UNICA.

050
800
455





1200510

SI
STE
MA

12.
FINITURA: NOBILITATO MIELE.
LAVABO: GLOBAL 1.

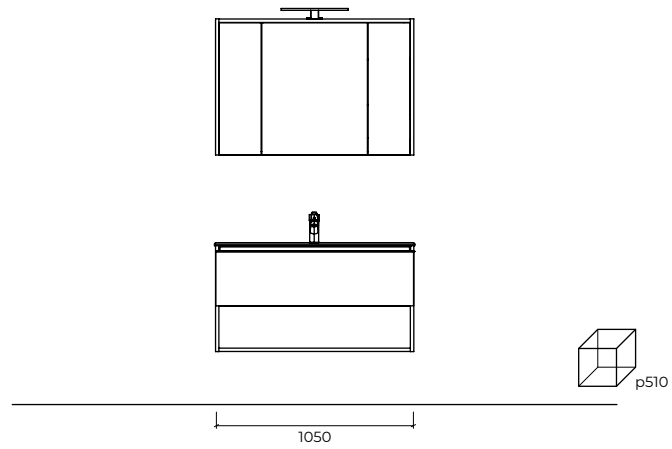

FINISH: MIELE LAMINATE.
INTEGRAL BASIN: GLOBAL 1.

FINITION: STRATIFIÉ MIELE.
PLAN-VASQUE: GLOBAL 1.



MI
SU
RA 47

CONSOLLE **GLOBAL** 120 CM CON VASCA CENTRALE O DESTRA/SINISTRA.

GLOBAL INTEGRAL BASIN W.120 WITH CENTRAL, RIGHT OR LEFT BASIN.

PLAN-VASQUE **GLOBAL** L.120 CM AVEC VASQUE CENTRALE, DROITE OU GAUCHE.

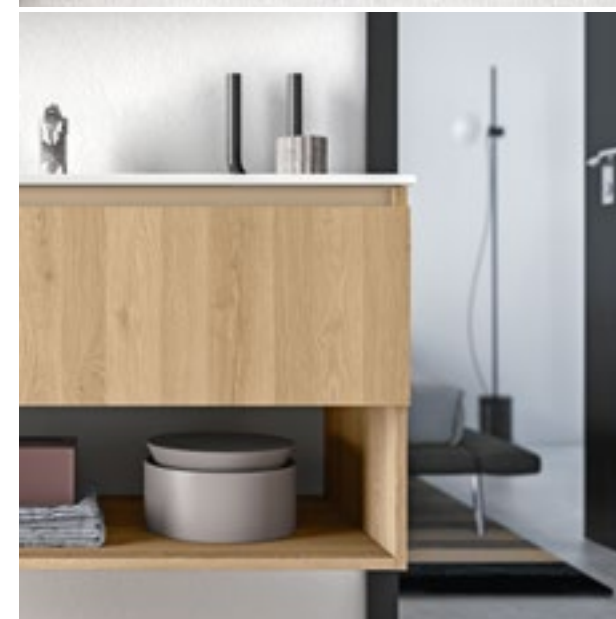



510
1050



13.
FINITURA: NOBILITATO STRADA/
LACCATO NICHEL OPACO.
LAVABO: WINGS DX.

FINISH: STRADA LAMINATE/
MATT NICKEL LACQUERED.
INTEGRAL BASIN: WINGS DX.

FINITION: STRATIFIÉ STRADA/
LAQUÉ NICHEL MAT.
PLAN-VASQUE: WINGS DX.



1200510

14.
 FINITURE: LACCATO BIANCO
 LUCIDO/LACCATO BIANCO OPACO.
 LAVABO: GLOBAL DX.

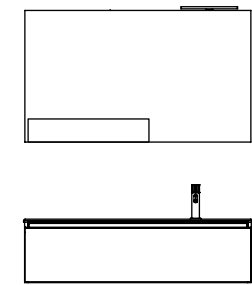

1200

FINISHES: GLOSSY BIANCO
 LACQUERED/MATT BIANCO LACQUERED.
 INTEGRAL BASIN: GLOBAL DX.

FINITIONS: LAQUÉ BIANCO
 BRILLANT/LAQUÉ BIANCO MAT.
 PLAN-VASQUE: GLOBAL DX.



BASE LAVABO DA 120 CM ANCHE CON
CONSOLLE **GLOBAL** DOPPIO LAVABO.

WASHBASIN UNIT W.120 CM AVAILABLE ALSO
WITH **GLOBAL** INTEGRAL BASIN, WITH DOUBLE
BASIN.

ÉLÉMENT SOUS-VASQUE L.120 CM DISPONIBLE
AUSSI AVEC PLAN-VASQUE **GLOBAL**, AVEC
DOUBLE VASQUE.



220
950
510

15.
FINITURA: NOBILITATO SILVER.
LAVABO: GLOBAL 1.

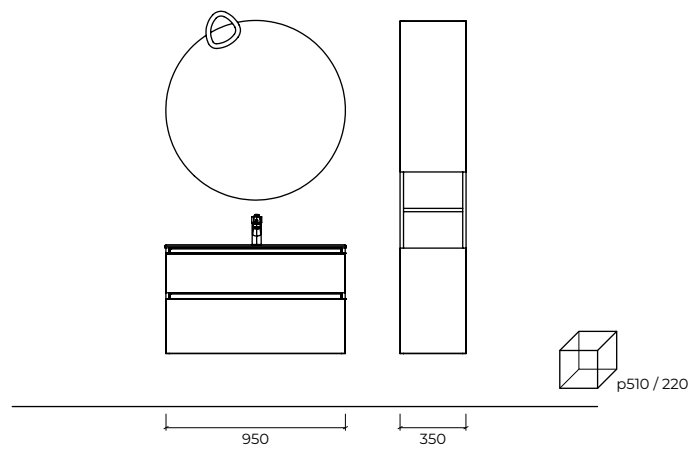

FINISH: SILVER LAMINATE.
INTEGRAL BASIN: GLOBAL 1.

FINITION: STRATIFIÉ SILVER.
PLAN-VASQUE: GLOBAL 1.





16.
 FINITURE: NOBILITATO EFFETTO MALTA
 COLORE TALPA/NOBILITATO EFFETTO
 MALTA COLORE CRETA.
 LAVABO: WINGS SX.

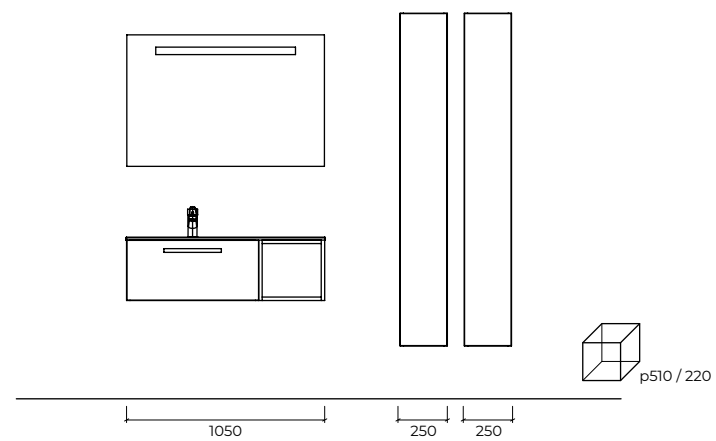

FINISHES: TALPA COLOUR MALTA
 EFFECT LAMINATE/CRETA COLOUR MALTA
 EFFECT LAMINATE.
 INTEGRAL BASIN: WINGS SX.

FINITIONS: STRATIFIÉ EFFET MALTA
 COULEUR TALPA/STRATIFIÉ EFFET MALTA
 COULEUR CRETA.
 PLAN-VASQUE: WINGS SX.

220
 1050
 510



CONSOLLE **WINGS** IN MARMORESINA
CON VASCA DECENTRATA DESTRA O SINISTRA.



WINGS INTEGRAL BASIN IN HARD RESIN
WITH BASIN ON THE RIGHT OR ON THE LEFT.

PLAN-VASQUE **WINGS** EN MARBRE
DE SYNTHÈSE AVEC VASQUE À DROITE
OU À GAUCHE.



5101050

17.
FINITURE: LACCATO OPACO RAL 1019/
NOBILITATO MESH.
LAVABO: WINGS SX.

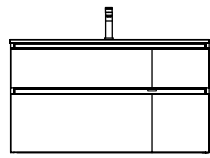
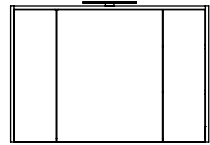

1050

FINISHES: MATT RAL 1019
LACQUERED/MESH LAMINATE.
INTEGRAL BASIN: WINGS SX.

FINITIONS: LAQUÉ RAL 1019
MAT/STRATIFIÉ MESH.
PLAN-VASQUE: WINGS SX.





18.
 FINITURE: NOBILITATO
 EUCALIPTO/LACCATO OPACO RAL 1013.
 LAVABO: GLOBAL 1.

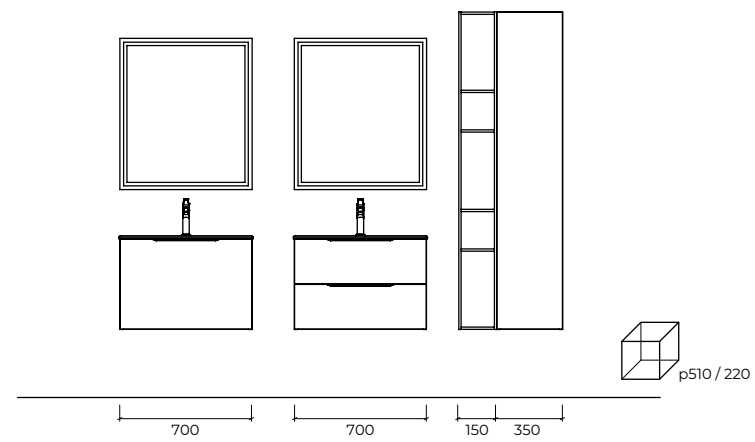

FINISHES: EUCALIPTO LAMINATE/MATT
 RAL 1013 LACQUERED.
 INTEGRAL BASIN: GLOBAL 1.

FINITIONS: STRATIFIÉ EUCALIPTO/LAQUÉ
 RAL 1013 MAT.
 PLAN-VASQUE: GLOBAL 1.



220
 700
 510

COLONNE A GIORNO E CON ANTA
COMPLETANO LA COMPOSIZIONE.

OPEN **FULL-HEIGHT UNITS** AND
FULL-HEIGHT UNITS WITH DOOR COMPLETE
THE COMPOSITION.

NICHES OUVERTES ET **COLONNES** AVEC PORTE
COMPLÈTENT LA COMPOSITION.



19.
FINITURA: NOBILITATO EFFETTO MALTA
COLORE GRIGIO.
LAVABO: UNICA.

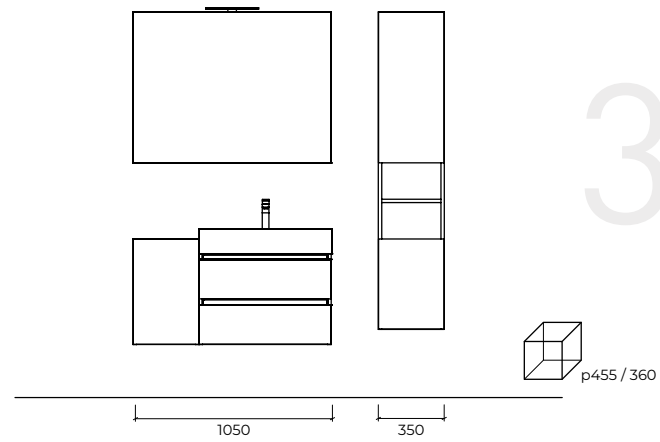

FINISH: GRIGIO COLOUR MALTA
EFFECT LAMINATE.
INTEGRAL BASIN: UNICA.

FINITION: STRATIFIÉ EFFET MALTA
COULEUR GRIGIO.
PLAN-VASQUE: UNICA.

360
1050
455





20.
FINITURE: NOBILITATO WHITE/LACCATO
BIANCO OPACO.
LAVABO: WINGS 1.

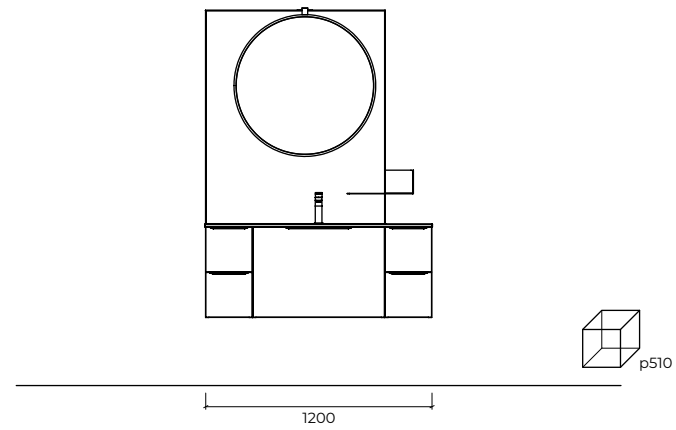

FINISHES: WHITE LAMINATE/MATT
BIANCO LACQUERED.
INTEGRAL BASIN: WINGS 1.

FINITIONS: STRATIFIÉ WHITE/LAQUÉ
BIANCO MAT.
PLAN-VASQUE: WINGS 1.

1200⁵¹⁰





510 1200

21.
FINITURE: NOBILITATO MESH/
NOBILITATO GRIGIO MINERALE.
LAVABO: GLOBAL 1.

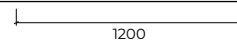
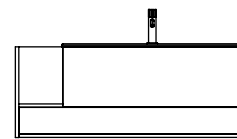
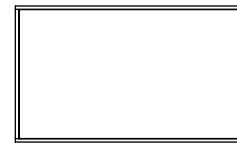

FINISHES: MESH LAMINATE/GRIGIO
MINERALE LAMINATE.
INTEGRAL BASIN: GLOBAL 1.

FINITIONS: STRATIFIÉ MESH/STRATIFIÉ
GRIGIO MINERALE.
PLAN-VASQUE: GLOBAL 1.



950360

22.
FINITURE: LACCATO LUCIDO
RAL 5021/LACCATO OPACO BIANCO.
LAVABO: JANE 95.

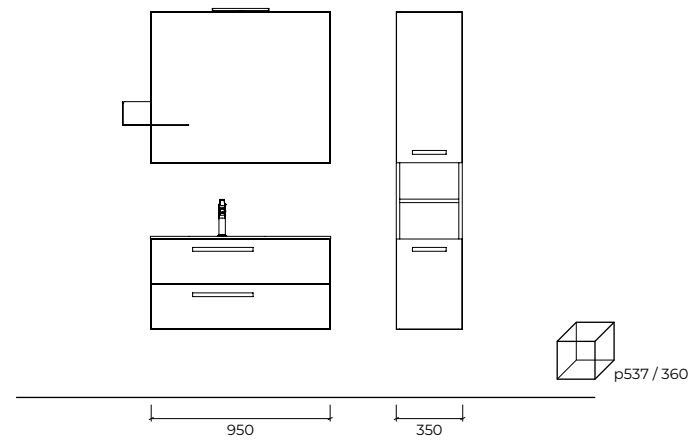

FINISHES: GLOSSY RAL 5021
LACQUERED/MATT BIANCO LACQUERED.
INTEGRAL BASIN: JANE 95.

FINITIONS: LAQUÉ RAL 5021
BRILLANT/LAQUÉ BIANCO MAT.
PLAN-VASQUE: JANE 95.



537
SI
STE
MA



MI
SU
RA

by

APERTURE
OPENING SYSTEMS
SYSTÈMES D'OUVERTURE

SEGNO
CARTA
BIANCA

MANIGLIE CARTABIANCA / CARTABIANCA HANDLES / POIGNÉES CARTABIANCA



COD. MAN030

FINITURA ALLUMINIO INOX
STAINLESS ALUMINIUM FINISH
FINITION ALUMINIUM INOXYDABLE



COD. MAN033

FINITURA ANTRACITE OPACO
ANTRACITE MATT FINISH
FINITION ANTRACITE MAT



COD. MAN034

FINITURA NICHEL SATINATO
SATIN NICKEL FINISH
FINITION NICKEL SATINÉ



COD. MAN031

FINITURA LACCATA
LACQUERED FINISH
FINITION LAQUÉE



COD. MAN031

FINITURA PIOMBO
LEAD FINISH
FINITION PLOMB



COD. MAN005

FINITURA CROMO
CHROME FINISH
FINITION CHROME



COD. MAN032

FINITURA CHAMPAGNE
CHAMPAGNE FINISH
FINITION CHAMPAGNE

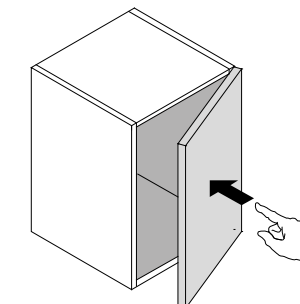

COD. PPL001

PUSH-PULL PER ANTA
PUSH-PULL FOR DOOR
PUSH-PULL POUR PORTE

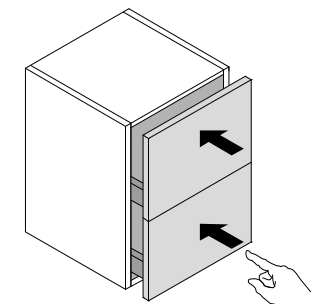

COD. PPL002

PUSH-PULL PER CASSETTO
PUSH-PULL FOR DRAWER
PUSH-PULL POUR TIROIR

GOLA SEGNO / SEGNO GROOVE / GORGE SEGNO



GOLA SEGNO
SEGNO GROOVE
GORGE SEGNO

FINITURE MOBILI / UNITS FINISHES / FINITIONS DES ÉLÉMENTS

NOBILITATI COLORATI / COLOURED LAMINATES / STRATIFIÉS COLORÉS

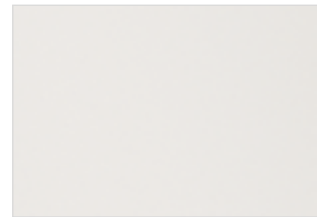

WHITE

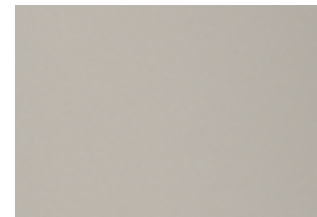

GRIGIO FUMO



GRIGIO DORIAN

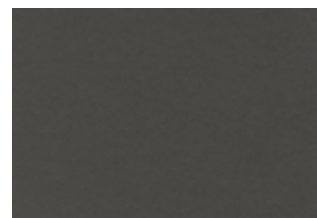

GRIGIO MINERALE



SABBIA

NOBILITATI ESSENZE / WOODEN FINISH LAMINATES / STRATIFIÉS FINITION BOIS



SILVER



FUSION



COSMOPOLITAN



MIELE



EUCALIPTO



MESH



TABACCO



MOKA

FINITURE MOBILI / UNITS FINISHES / FINITIONS DES ÉLÉMENTS

NOBILITATI MATERICI / MATERIAL LAMINATES / STRATIFIÉS MATÉRIAUX



STRADA



METALLICO

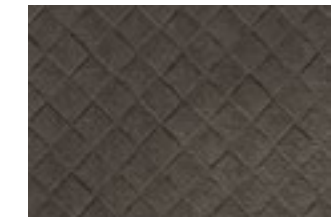

INTRECCIO

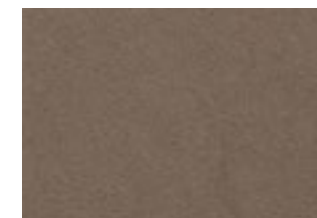

EFFETTO MALTA
COLORE TALPA



EFFETTO MALTA
COLORE GRIGIO

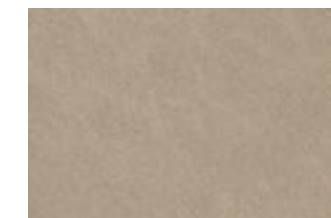

EFFETTO MALTA
COLORE CRETA

LACCATI / LACQUERED / LAQUÉ

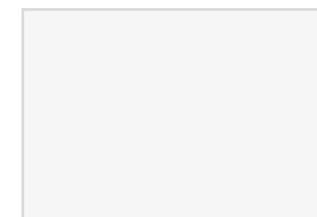

BIANCO OPACO



BIANCO LUCIDO



NICHEL

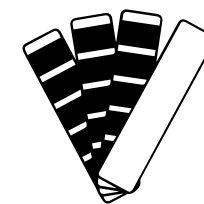

COLORE OPACO/LUCIDO RAL

LA RIPRODUZIONE DELLE FINITURE È DA CONSIDERARSI PURAMENTE INDICATIVA.
FINISHES REPRODUCTIONS HAVE TO BE CONSIDERED INDICATIVE.
LES REPRODUCTIONS DES FINITIONS SONT À CONSIDÉRER INDICATIVES.

LAVABI / INTEGRAL BASINS / PLANS-VASQUE

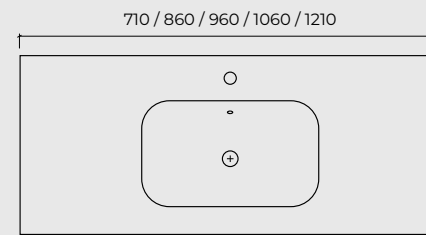

GLOBAL 1

CERAMICA BIANCA
WHITE CERAMIC
CÉRAMIQUE BLANCHE

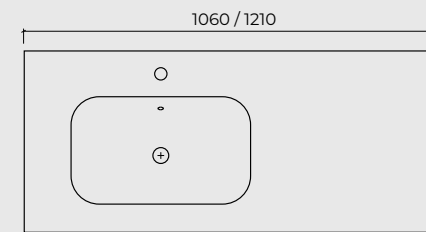

GLOBAL DX-SX

CERAMICA BIANCA
WHITE CERAMIC
CÉRAMIQUE BLANCHE

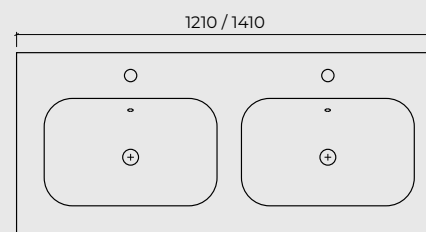

GLOBAL 2

CERAMICA BIANCA
WHITE CERAMIC
CÉRAMIQUE BLANCHE

LAVABI / INTEGRAL BASINS / PLANS-VASQUE

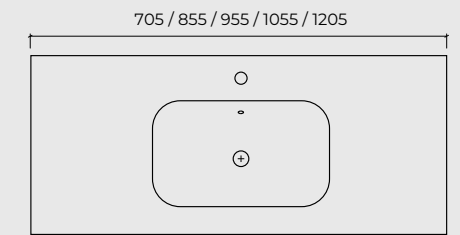

WINGS

MARMORESINA BIANCO LUCIDO E OPACO
GLOSSY AND MATT BIANCO HARD RESIN
MARBRE DE SYNTHÈSE BIANCO BRILLANT ET MAT

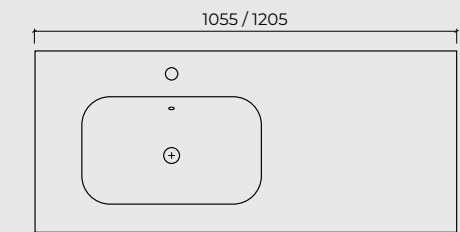

WINGS DX-SX

MARMORESINA BIANCO LUCIDO E OPACO
GLOSSY AND MATT BIANCO HARD RESIN
MARBRE DE SYNTHÈSE BIANCO BRILLANT ET MAT

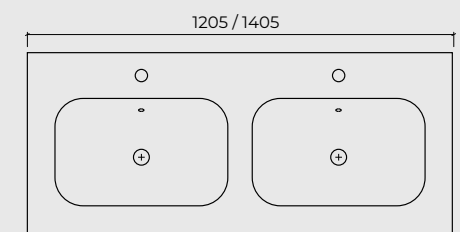

WINGS 2

MARMORESINA BIANCO LUCIDO E OPACO
GLOSSY AND MATT BIANCO HARD RESIN
MARBRE DE SYNTHÈSE BIANCO BRILLANT ET MAT

LAVABI / INTEGRAL BASINS / PLANS-VASQUE

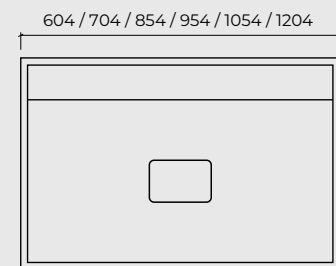
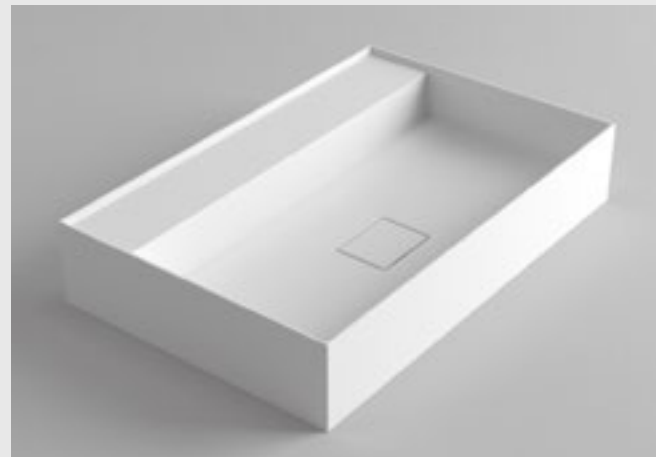

UNICA

SOLID SURFACE BIANCO OPACO
MATT BIANCO SOLID SURFACE
SOLID SURFACE BIANCO MAT

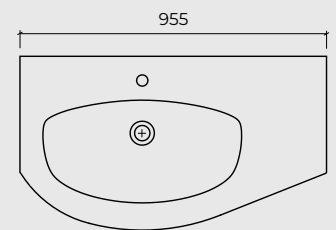

JANE 95

MARMORESINA BIANCO LUCIDO
GLOSSY BIANCO HARD RESIN
MARBRE DE SYNTHÈSE BIANCO BRILLANT

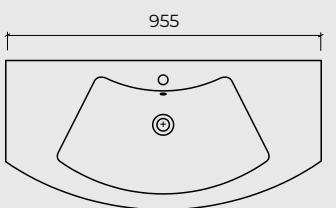

ONDA 95

MARMORESINA BIANCO LUCIDO
GLOSSY BIANCO HARD RESIN
MARBRE DE SYNTHÈSE BIANCO BRILLANT

2019

COCERASA®

DESIGN: CERASA STUDIO

IMMAGINI: QUATTROTERZI STUDIO

FOTOGRAFIA ED EDITING: PHOTOGRAFICA

STYLING: FEDERICA BARO

FOTOLITO: GM STUDIO 1

STAMPA: IMOCO S.P.A.



ATHENACONCEPT.COM

