

NEXT



PRIANERA®



La massima **attenzione** nella ricerca dei migliori pellami e tessuti sta alla base dell'unicità e della riconoscibilità dello stile Prianera. Appena le pelli entrano in azienda vengono analizzate singolarmente e utilizzate per esprimerne al meglio il loro valore.

The utmost care and **precision** in researching the best leathers and fabrics is the starting point that makes Prianera style unique and recognizable. As soon as the leathers arrive at the company they undergo scrupulous controls and then are used in a way to express their value at best.



La grande esperienza artigianale guida la **matita** lungo il contorno delle dime per selezionare le parti migliori sulle pelli eliminando eventuali difetti.

A great handcrafted experience guides the **pencil** around the templates choosing the best parts of the leather excluding any defects.



Ogni pezzo segue un percorso sartoriale unico e personalizzato. La scelta del colore del filo o del materiale del **filetto** sono solo alcuni dei particolari che rendono il prodotto espressione della propria personalità.

Every piece goes through a unique and customized sartorial process. The choice of the thread color or the **pipng** material are just some of the details which make the product an expression of your own personality.

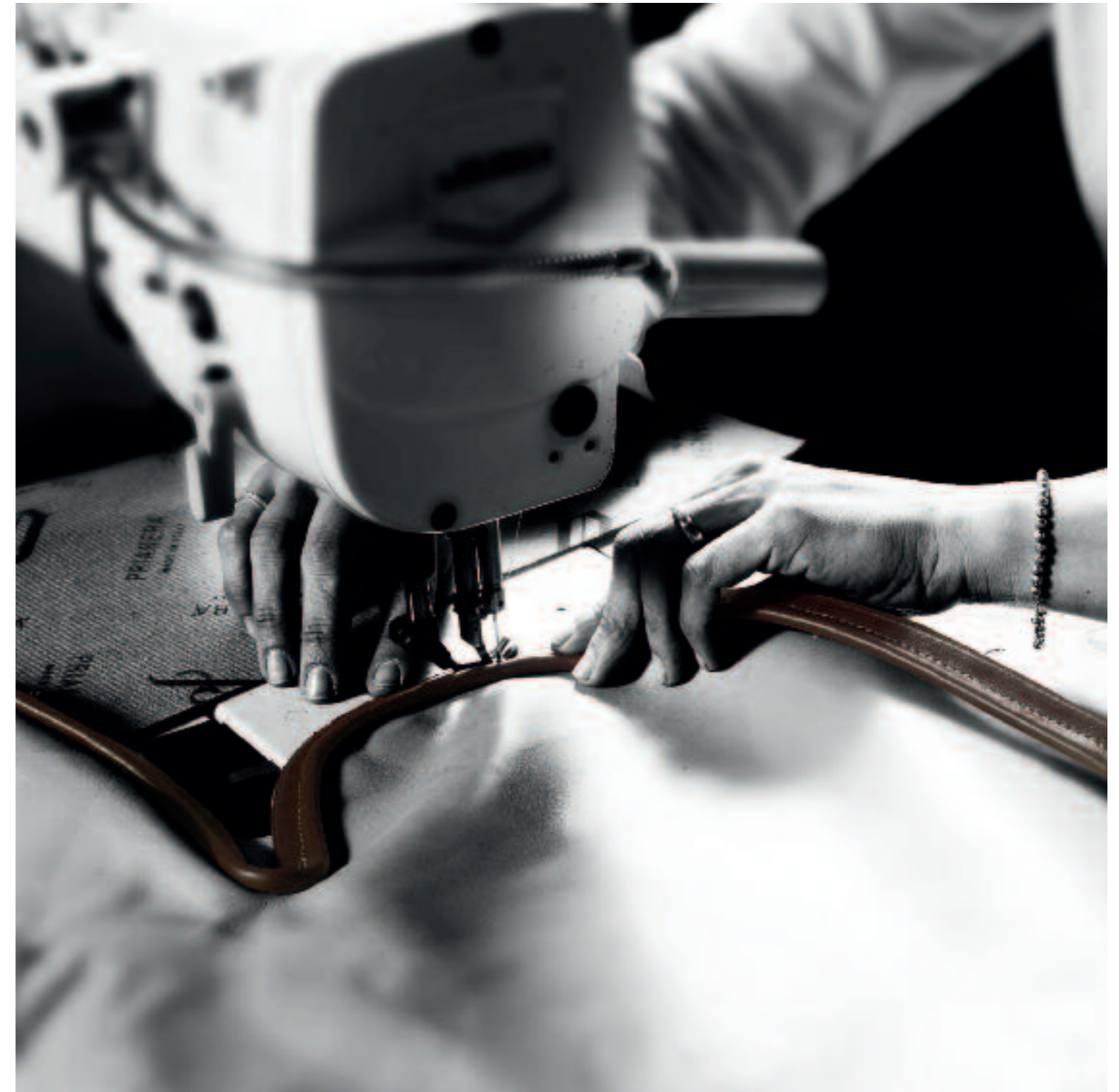

Il taglio contemporaneo della collezione è impreziosito dai **ricami esclusivi** Prianera, che rendono unico e inconfondibile l'elegante tocco artigianale del brand.

The contemporary aspect of the collection is enriched by Prianera **exclusive embroideries** which add a special uniqueness to the artisan elegance of the brand.



Icona classica per eccellenza, il **capitoné** viene esaltato grazie alla ricca collezione di pelli e tessuti Prianera. Ogni piegatura è eseguita singolarmente, così come i bottoni inseriti uno ad uno manualmente.

Quintessence of the classic style, **capitoné** workmanship is enhanced by the rich Prianera leather and fabric collection. Each fold is performed individually, as well as the buttons are inserted one by one by hand.



## PRIANERA NEXT ANTHOLOGY

---



TURANDOT p. 10



MEDEA p. 20



PASSEPARTOUT p. 21



OPERA p. 22



MIVIDA p. 38



OPERA DAYBED p. 46



TOSCA p. 50



YUCATAN p. 58



OUVERTURE p. 66



RIGOLETTO p. 68



CAPRI - GIGLIO - GAVI - ISCHIA p. 76



NILO p. 78



NILO p. 86



BOHEME p. 88



OTELLO p. 100



ALFRED p. 108



OLIVIA p. 114



VALENTINO p. 118



NABUCCO p. 124

Ispirato a principi di eleganza e autenticità, Turandot esprime l'anima del **design** contemporaneo fondendo l'essenzialità della leggera struttura e dei piedi cilindrici, entrambi in metallo, con il comfort conferito dal cuscino intero di seduta.

Inspired by the principles of elegance and authenticity, Turandot expresses the soul of contemporary **design** blending together the materiality of the thin iron structure and of the cylindrical metal feet with the comfort conferred by the only big seat cushion.

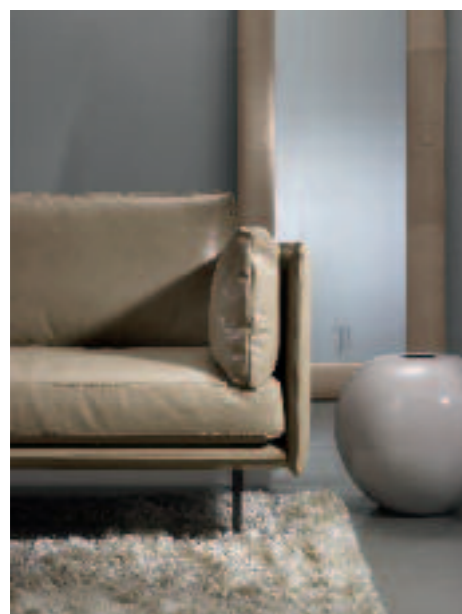

## TURANDOT design: Style Department Prianera

**TURANDOT** Armchair in Leather Sequoia color Terra

**PINCH** Pillow in Via della Spiga color 04 Fabric and Leather Stonewash color Dark Brown belt with metal buckle

**GAVI** Coffee Table with Calacatta Marble top and Matte Black finishing

**MEDEA** Mirror in Leather Stonewash color Light Grey with exclusive Prianera Embroidery





**TURANDOT** Composition in Fabric via della Spiga color 04  
**PINCH** Pillow in Via della Spiga color 04 Fabric and Leather  
Stonewash color Dark Brown belt with metal buckle  
**ALADINO** Round Ottoman in Acropoli Fabric  
**CAPRI** and **ISCHIA** Coffee Tables with Shining Grey Ash  
Wood top and Matte Black finishing  
**GIGLIO** Coffee Table with Calacatta Marble top and Matte  
Black finishing  
**SPLENDIDO** Carpet color Antracite  
**SETOSO** Carpet color Bianco\_Avorio 01







TURANDOT Sofa in Leather Stonewash color Ecrù  
SETOSO Carpet color Bianco\_Avorio 01  
MEDEA Mirror in Leather Stonewash color Light Grey with exclusive Prianera Embroidery



**TURANDOT** Sofa in Leather Stonewash color Ecrù  
**CAPRI** Coffee Table with Shining Grey Ash Wood top and Matte Black finishing  
**GIGLIO** Coffee Table with Calacatta Marble top and Matte Black finishing  
**MEDEA** Mirror in Leather Stonewash color Light Grey with exclusive Prianera Embroidery  
**SPLENDIDO** Carpet color Antracite  
**SETOSO** Carpet color Bianco\_Avorio 01





**MEDEA** Mirror in Leather Stonewash color Light Grey with exclusive Prianera Embroidery  
**SETOSO** Carpet color Bianco\_Avorio 01



**PASSEPARTOUT** Ottomans in Leather Truman color Barley with exclusive Prianera Embroidery, in Acropoli  
Fabric color 04, in Leather Sequoia color Terra

"Il pensiero fondante del progetto Opera, oltre all'utilizzo di linee volutamente basiche, contiene l'evoluzione del concetto di seduta che diventa altro: una vera e propria piattaforma open-source, in grado di cambiare funzione con il modificarsi delle esigenze e che invita a cercare soluzioni ogni volta diverse. Opera fotografa un nuovo modo di vivere gli spazi quotidiani, all'insegna della versatilità e del dinamismo, nella vita come nel design". **Giorgio Ragazzini**

"The thinking behind the Opera project, in addition to the use of basic lines, contains the evolution of the concept of seat which in fact here becomes something else: a real open-source platform able to change function according to different needs and invites you to look for different solutions every time.

Opera is a new way of living the daily spaces in the name of versatility and dynamism, in life as in design".

**Giorgio Ragazzini**



## OPERA design: Giorgio Ragazzini

**OPERA** Composition in Fabric Praiano color 07 and Fabric Midtown color 17 and Leather Bosphore color Corteccia

**OPERA** Sofa in Leather Bosphore color Cenere

**OPERA** Coffee Table with Calacatta Marble top and Nickel finishing

**GAVI** and **GIGLIO** Coffee Tables with Calacatta Marble top and Rust finishing

**CAPRI** Coffee Table with Talpa Beech Wood top and Matte Black finishing

**SPLENDIDO** Carpet color Moro

**SETOSO** Carpets color Bianco\_Avorio 01 and Beige\_Marrone 02





06:00 pm Valeggio sul Mincio, VERONA \_ Italy











La pelle **Bosphore** presenta una grana naturale ed omogenea su tutta la superficie. Speciali ingrassi di elevata qualità esaltano la sua naturale morbidezza.

**Bosphore** leather features a natural and uniform grain. Special high-quality fatliquorings enhance its natural softness.



Nell'ampia gamma di rivestimenti, una selezione delle coloriture della pelle Bosphore di Prianera, particolarmente adatta ad esaltare la lavorazione trapuntata delle sedute **Opera**. Tutte le sedute sono disponibili sia in versione liscia che trapuntata.



Within the wide range of Prianera upholsteries this is a color selection of leather Bosphore which is particularly suitable for enhancing the quilted workmanship of the **Opera** elements. All the seats are available in both plain and quilted version.



**OPERA** Composition in Fabric Praiano color 07 and Fabric Midtown color 17 and Leather Bosphore color Corteccia  
**OPERA** Coffee Table with Calacatta Marble top and Nickel finishing  
**CAPRI** Coffee Table with color Talpa Beech Wood top and Matte Black finishing  
**SETOSO** Carpets color Bianco\_Avorio 01 and Beige\_Marrone 02



**OPERA** Sofa in Leather Bosphore color Cenere  
**GAVI** and **GIGLIO** Coffee Tables with Calacatta Marble top and Rust finishing  
**SPLENDIDO** Carpet color Moro

"Il sistema di sedute modulari e fisse Opera vuole rappresentare un progetto integrale di progettazione e arredamento dell'ambiente living per garantire sempre il massimo del relax e tanto spazio per esprimere la propria creatività, il proprio stile di vita e la voglia di comunicare". **Giorgio Ragazzini**

"Opera's modular and fixed seating system aims to represent a whole project of both interior design and furnishing of the living spaces in order to guarantee always maximum relaxation and plenty of room to express your own creativity, your own lifestyle and desire to communicate". **Giorgio Ragazzini**



**OPERA** design: Giorgio Ragazzini

Con i nostri occhi noi osserviamo. In base al punto di osservazione prescelto, essi ci mostrano coreografie sempre nuove, fatte di forme scultoree, di proporzioni diverse, che creano ritmi pieni di tensioni. Giochi visivi di tale effetto sono possibili soltanto grazie ad un **design senza tempo**, proprio come quello di Mivida.

With our eyes we observe. From different points of view they show us always new choreographies made of sculptural shapes and different proportions that create rhythms full of power. Such powerful visual effects are possible only thanks to a **timeless** piece of **design** like Mivida.



**MIVIDA** design: Angelo Tomaiuolo

**MIVIDA** Armchair in Leather Stonewash color Light Grey with Leather Stonewash color Dark Brown piping and Talpa Beech Wood base  
**TRIAL** Coffee Tables in Nickel finishing metal with Leather Stonewash color Dark Brown top  
**SPLENDIDO** Carpet color Antracite







**MIVIDA** Sofa in Leather Stonewash color Light Grey with Leather Stonewash color Dark Brown piping and Calacatta Marble top and Talpa Beech Wood base  
**MIVIDA** Coffee Tables in Talpa Beech Wood and Calacatta Marble top  
**SPLENDIDO** Carpets color Antracite and Moro



"La collezione **Mivida** è un omaggio alla cultura sartoriale e alla tradizione artigianale del nostro territorio. L'ispirazione classica delle sue linee morbide ed eleganti ha origine dalla prodigiosa ricerca estetica del barocco italiano, riattualizzata in chiave contemporanea per un comfort senza tempo". **Angelo Tomaiuolo**

"**Mivida** collection is a tribute to the sartorial culture and artisan tradition of our territory. The classic inspiration of its soft and elegant lines takes its origin from the prodigious aesthetic research of Italian Baroque, updated in a contemporary way for a timeless comfort". **Angelo Tomaiuolo**



**MIVIDA** design: Angelo Tomaiuolo

Forma, funzione, materiali. Tutti gli elementi formali di Opera parlano un linguaggio semplice e chiaro e ogni singola funzione è pensata nei minimi **dettagli**. I materiali utilizzati sono caratterizzati da finiture e lavorazioni perfette e da un livello di qualità visibile in ogni particolare.

Shape, function, materials. Each single Opera element speaks a simple and clear language and every function is designed with scrupulous attention to **details**. All the materials are characterized by perfect finishings, skilled handworks and top quality.



## OPERA DAYBED design: Giorgio Ragazzini

OPERA DAYBED in Via della Spiga color 04 Fabric. Roll in Leather Stonewash color Dark Brown with metal buckle  
PINCH Pillow in Via della Spiga color 04 Fabric and Leather Stonewash color Dark Brown belt with metal buckle  
OPERA Coffee Table with Calacatta Marble top and Nickel finishing  
SPLENDIDO Carpet color Moro







OPERA Coffee Table with Calacatta Marble top and Nickel finishing



Tosca è un'opera artigianale che si svolge in tre atti: la morbidezza del **comfort** avvolgente si esalta specchiandosi nelle pieghe soffici della pelle e del tessuto, la continuità e l'eleganza delle linee conferiscono uno stile unico e inconfondibile e la sua versatilità nei rivestimenti le dona sfumature sempre nuove.

Tosca is a piece of art in three different ways: the softness of the enveloping **comfort** is enhanced by the soft folds of leather and fabric, the sinuosity and elegance of the lines give a unique and unmistakable style and the versatility in upholsteries and finishings gives it always new shades and lives.



## TOSCA design: Carlo Bimbi

**TOSCA** Armchair and Sofa in Leather Stonewash color Deer with Matte Black finishing metal feet  
**GAVI** Coffee Table in Leather Stonewash color Deer top and Matte Black finishing  
**SETOSO** Carpet color Bianco\_Avorio 01  
**SPLENDIDO** Carpet color Nocciola

06:30 pm CHICAGO \_ USA







**Stonewash** è una pelle a pieno fiore tinta all'anilina con finitura naturale. Le pelli vengono conciate e riconciate al vegetale, gli speciali ingrassi preservano ed esaltano la naturale morbidezza di questa pelle liscia e senza grana, **Stonewash** is a full grain leather with natural finishing. These leathers are chrome-tanned and vegetal re-tanned, a night-time air exposure completes the drying phase of this smooth and grainless leather in a natural way.



TOSCA Armchair and Sofa in Leather Stonewash color Antracite with Gold finishing metal feet



TOSCA Armchair in Carrè and Carrè Unito Fabric color 05 with Nickel finishing metal feet  
TRIAL Coffee Table in Leather Texas Nabuk color Crema and Gold finishing metal  
SPLENDIDO Carpet color Beige



La storia e l'evoluzione che si intrecciano: un pezzo storico e di successo che non finisce di stupire. **Yucatan** si arricchisce di nuove modularità e accessori divenendo un modello trasversale, adatto a qualsiasi ambiente. Le innumerevoli opzioni e personalizzazioni valorizzano il design lineare e contemporaneo e il comfort di pregio.

History and evolution intertwined: a historical and successful piece that continues to amaze. **Yucatan** is enriched with new modularity and accessories, becoming a model suitable for any environment. The countless options and personalizations enhance the linear and contemporary design and the precious comfort.



## YUCATAN design: Fabrizio Ballardini

**YUCATAN** Composition in Leather Georgia color Bird  
**TOSCA** Armchair in Leather Stonewash color Deer with Matte Black finishing metal feet  
**GAVI** Coffee Table in Leather Stonewash color Deer top and Matte Black finishing  
**CAPRI** and **GIGLIO** Coffee Tables in Port Laurent Marble top and Matte Black finishing  
**SETOSO** Carpets color Bianco\_Avorio 01 and Beige\_Marrone 02  
**SPLENDIDO** Carpet color Beige







YUCATAN Composition in Leather Georgia color Bird  
SETOSO Carpets color Bianco\_Avorio 01 and Beige\_Marrone 02







YUCATAN Sofa in fabric Midtown color 17 with OUVERTURE Bookcase in Noce Canaletto Wood  
SPLENDIDO Carpet color Beige



Rigoletto mette la tecnica al servizio del design per creare spazi e situazioni di puro relax all'interno di forme eleganti e dettagli preziosi come le trapuntature delle sedute e le tasche laterali portaoggetti. L'ampio meccanismo permette di **cambiare la profondità** di ogni singolo schienale e ottenere un comfort ottimale.

Rigoletto puts technique at the service of design in order to create spaces and situations of pure relaxation within elegant shapes and precious details such as the quilts of the seats and the side pockets. The mechanism allows **to change the depth** of each individual backrest and achieve the perfect comfort.



## RIGOLETTO design: Style Department Prianera

RIGOLETTO Composition in Leather Texas Nabuk color Crema

ISCHIA and CAPRI Coffee Tables with Onice Tanzania Marble top and Gold finishing metal

TOSCA Armchair in Carrè and Carrè Unito Fabric color 05 with Nickel finishing metal feet

BOHEME Bench in Carrè Unito Fabric color 05

ABACO Coffee Table in Leather Texas Nabuk color Crema and Wengè Beech Wood feet

TRIAL Coffee Table in Leather Texas Nabuk color Crema and Gold finishing metal

SETOSO Carpet color Bianco\_Avorio 01

SPLENDIDO Carpet color Beige







RIGOLETTO Composition in Leather Texas Nabuk color Crema  
BOHEME Bench in Carrè Unito Fabric color 05  
ABACO Coffee Table in Leather Texas Nabuk color Crema and  
Wengè Beech Wood feet  
SPLENDIDO Carpet color Beige





**ISCHIA** and **CAPRI** Coffee Tables with Onice Tanzania Marble top and Gold finishing metal



**PASSEPARTOUT** Ottomans in More is More and Prince of Wales DEDAR fabric, piping and bottom in Leather Stonewash color Ecrù  
**PILLOW** in Leather Texas Nabuk color Crema with exclusive Prianera Embroidery

Una collezione completa di tavolini in varie altezze e dimensioni. Strutture in metallo e piani d'appoggio sono disponibili in molteplici finiture, dai marmi più pregiati al legno con superfici lucide e opache, oppure nelle pelli di Prianera. La collezione **Isole** è stata disegnata da Carlo Bimbi.

A complete coffee tables collection with different heights and dimensions. Metal structures and tops are available in many finishings, from the finest marbles to the wood with glossy or matt surfaces or upholstered with the exclusive Prianera leathers. The **Isole collection** was designed by Carlo Bimbi.

GAVI

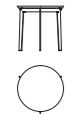

GIGLIO

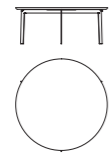

CAPRI

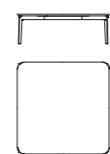

ISCHIA

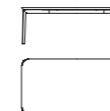
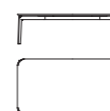

**ISOLE** design: Carlo Bimbi

Nuove **forme arrotondate** esaltano il design e il comfort che hanno da sempre contraddistinto il modello Nilo. Questa scenografica composizione introduce in un mondo di lusso contemporaneo in cui l'eleganza scaturisce da un sapiente uso dei materiali e da un accurato lavoro sui dettagli.

New **curved shapes** exalt design and comfort of model Nilo. This scenographic composition introduce a contemporary luxury universe, where elegance is given by a skillful mix of materials and a keen attention to details.

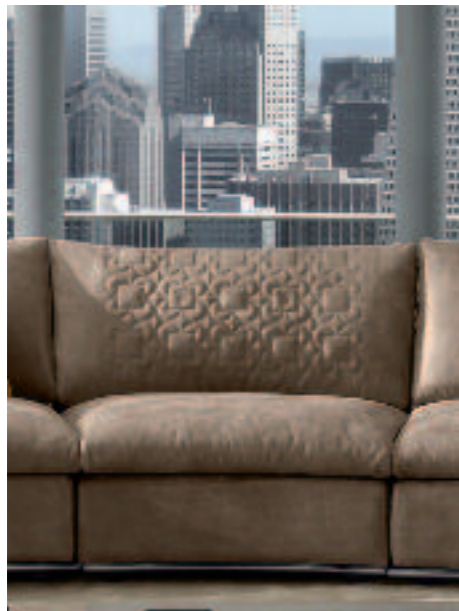

## NILO design: Fabrizio Ballardini

NILO Composition in Leather Truman color Barley and Ottoman with Calacatta Marble top  
KLAB Armchair in Nobilis cotton velvet Fabric color 08  
CAPRI and ISCHIA Coffee Tables with Talpa Beech Wood top and Matte Black finishing  
GIGLIO Coffee Table with Calacatta Marble top and Matte Black finishing  
PASSEPARTOUT Ottomans in Nobilis color 02 and Leather Truman color Barley  
SETOSO Carpet color Bianco\_Avorio 01 Beige\_Marrone 02  
SPLENDIDO Carpet color Beige







11:00 am SAN FRANCISCO \_ USA





**Truman** è una pelle all'anilina con nabuccatura e tintura eseguita in botte, lavorata a mano per donarle un aspetto vintage. Nell'ottoman Passepartout è stata personalizzata con l'esclusivo ricamo Prianera.

**Truman** is nabuck drum-dyed aniline leather, it is hand-sanded to get a "worn out" look. In the Passepartout Ottoman is enriched with the Exclusive Prianera Embroidery.

Barley



Tanganica



Africa



Terra



Echoes



Dark Blue



I dettagli diventano gli elementi che fanno la differenza.

Ogni divano ha una sua genesi, un suo stile che deve rispecchiare alla perfezione i gusti del committente e la sua personalità. La scelta del colore del filo o del materiale del filetto sono solo alcuni dei particolari che rendono questa composizione **Nilo con piping** una proposta ricercata ed esclusiva.

Details make the difference.

Each sofa has its own genesis and style which have to reflect perfectly client's tastes and personality. The choice of the thread color and piping material are just some of the details that make this **Nilo** composition **with piping** a refined and exclusive option.



**NILO** CON PIPING design: Fabrizio Ballardini

NILO Composition in Fabric Milos color 06 and Dark Leather piping



Il **capitoné** ha un archetipo imprescindibile: è il divano in pelle, anche detto Chesterfield, nato nell'Inghilterra edoardiana e mai passato di moda. Nel modello Boheme di Prianera ogni bottone è realizzato a mano e rivestito con la stessa pelle utilizzata per la struttura.

The **capitoné** has an essential archetype: it is the leather sofa, also called Chesterfield, born during the Edwardian England and never gone out of fashion.

In the Prianera model Boheme each button is handmade and upholstered with the same leather used for the structure.

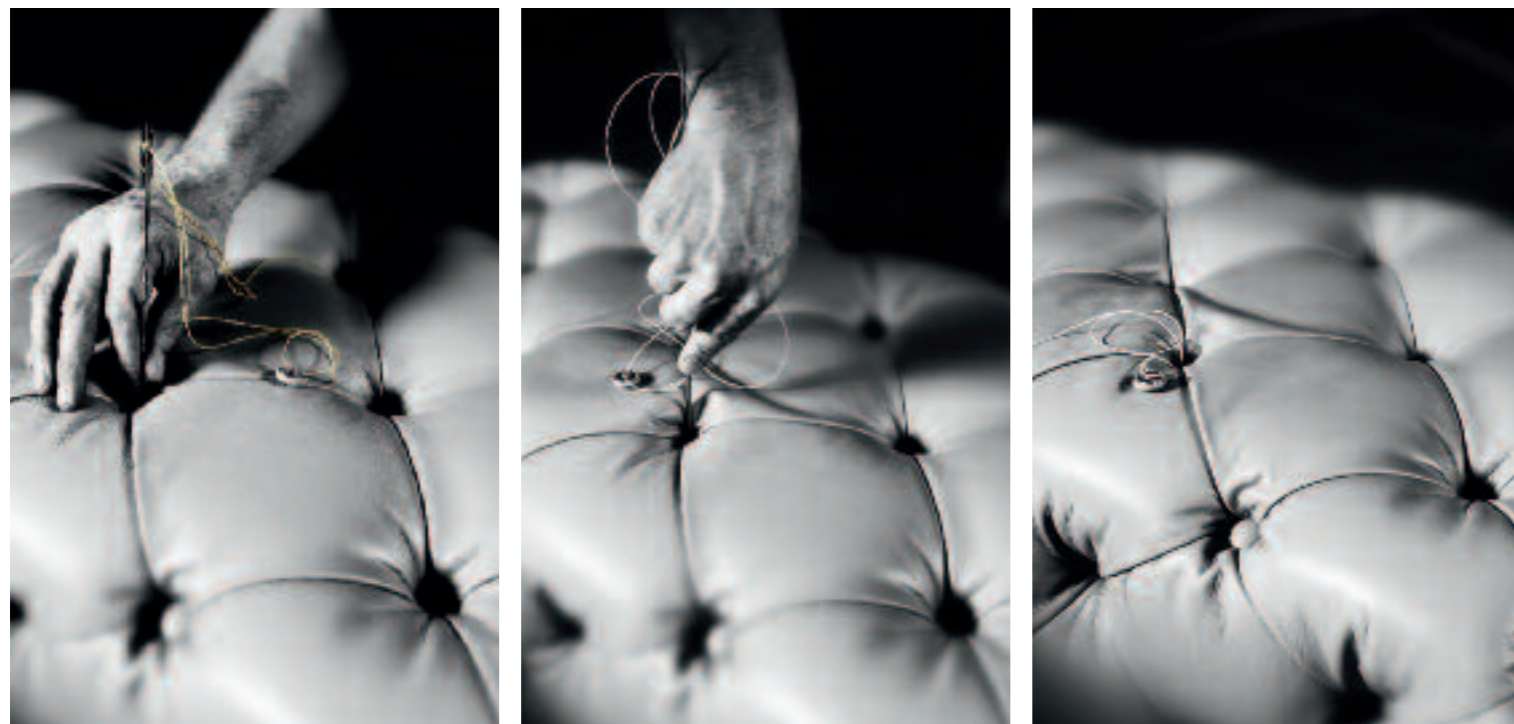

## BOHEME design: Style Department Prianera

BOHEME Sofa Maxi 300cm and Armchair in Leather Sequoia color Grigio

BOHEME Sofa in cotton velvet Fabric Nobilis color 13

ABACO Coffee Table in Leather Sequoia color Grigio and Wengè Beech Wood feet







BOHEME Sofa Maxi 300cm and Armchair in Leather Sequoia color Grigio  
BOHEME Sofa and Bench in cotton velvet Fabric Nobilis color 13  
ABACO Coffee Table in Leather Sequoia color Grigio and Wengè Beech Wood feet



BOHEME Armchair in Leather Sequoia color Grigio  
ABACO Coffee Table in Leather Sequoia color Grigio and Wengè Beech Wood feet



BOHEME Sofa Maxi 300cm in Leather Sequoia color Grigio  
BOHEME Sofa and Bench in cotton velvet Fabric Nobilis color 13





BOHEME Sofa in Leather Stonewash color Light Grey  
ALADINO Ottomans in cotton velvet Fabric Nobilis color 10





Tribute to Italian Opera, MILAN \_ Italy

I codici dell'artigianato d'eccellenza trionfano nel design del modello Otello. Unico e **contemporaneo**, Otello unisce forme estremamente eleganti e minimali a una robustezza e comfort senza eguali. Elegance craftsmanship codes triumph in model Otello design. Unique and **contemporary**, Otello mixes an extremely elegant and minimal design with a great strength and high comfort.



**OTELLO** design: Style Department Prienera

- OTELLO Composition in Leather Velluto color Taupe
- OTELLO High Armchair in Fabric Bellagio color 02
- OTELLO Sofa in Leather Georgia color Zenzero
- OTELLO Coffee Table with Matte Wengè Ash Wood top









**OTELLO** Sofa in Leather Texas Nabuk color Sabbia  
**CAPRI** and **ISCHIA** Coffee Tables with Talpa Beech Wood top and Matte Black finishing  
**GIGLIO** Coffee Table with Calacatta Marble top and Matte Black feet  
**SETOSO** Carpet color Avorio  
**SPLENDIDO** Carpet color Beige



Alfred è la naturale conseguenza della **mission Prianera**: creare living accoglienti che al contempo trasmettano quell'unicità dettata da uno stile inconfondibile. Un'unicità che prende forma dalla reciproca esaltazione di design, materiali, cuciture e accostamenti personalizzabili.

Alfred is the natural consequence of the **Prianera mission**: to create comfortable living spaces which at the same time are able to transmit that uniqueness resulted from an unmistakable style. Uniqueness that takes its form from the mutual exaltation of design, materials, stitchings and customizable combinations.



## ALFRED design: Carlo Bimbi

ALFRED Sofa in Leather Stonewash color Deer and Nickel finishing metal base

ALADINO Ottoman in DEDAR Fabric Prince of Wales

SPLENDIDO Carpet color Beige

DISEGNO Carpet color Mineral Black







**ALFRED** Sofa in Leather Stonewash color Deer and Nickel finishing metal base

**GAVI** Coffee Table in Leather Stonewash color Deer top and Gold finishing metal

**CAPRI** Coffee Table in Leather Stonewash color Deer top and Matte Black finishing

**ISCHIA** Coffee Table in Shining Grey Ash Wood top and Matte Black finishing metal

**CAPRI** Coffee Table in Shining Grey Ash Wood top and Gold finishing metal

**SPLENDIDO** Carpet color Beige





OLIVIA Armchair in Leather Stonewash color Light Grey with Leather Stonewash color Antracite piping





PASSEPARTOUT Ottomans in Leather Stonewash color Antracite and Light Grey and DEDAR Fabric More is More and Prince of Wales



L'arredamento incontra la moda nel modello Valentino, l'esperienza artigiana attinge dall'alta moda italiana con la medesima devozione ai dettagli. La forma curva della penisola rende omaggio al patrimonio artistico italiano creando un' **icona di stile** che esprime al meglio l'unicità di Prienera.

Furniture meets fashion. In model Valentino the artisanal experience pays tribute to Italian high fashion with a keen attention to details. The round peninsula pays tribute to the Italian heritage creating an **iconic item** well expressing Prienera uniqueness.



**VALENTINO** design: Style Department Prienera

VALENTINO Composition in Leather Texas Nabuk color Cenere with Leather Georgia color Botticino contrast piping  
ALADINO Ottoman in Fabric Bellagio color O2 and Villa d'Este color O2





Tribute to Italian Opera, MILAN \_ Italy



VALENTINO Sofa in Fabric Brera color 03 with optional wooden feet color Wengé  
TRIAL Coffee Tables with Leather Truman Dark Blue top and Ral 8022 Schwarzbraun finishing metal  
VALENTINO Composition in Leather Texas Nabuk color Cenere with Leather Georgia color Botticino contrast piping  
ALADINO Ottoman in Fabric Bellagio color 02 and Villa d'Este color 02



Prianera è l'esaltazione della storicità e dell'unicità di esclusivi **materiali naturali**. Nabucco porta con sé la storia di ogni singolo pellame sapientemente cucito ad arte e di ogni venatura nel legno della struttura, per dar vita ad un modello senza tempo.

Prianera is the exaltation of the historicity and uniqueness of exclusive **natural materials**. Nabucco carries the history of every wood grain and of every single leather stitched by expert hands for a timeless model.



## NABUCCO design: Style Department Prianera

**NABUCCO** Composition in Leather Stonewash color Light Grey and Talpa Beech Wood base

**GAVI** Coffe Table with Calacatta Marble top and Matte Black finishing

**GAVI, ISCHIA** and **CAPRI** Coffe Tables with Talpa Ash Wood top and Matte Black finishing

**ALICE** Armchairs in Fabric Villa Flori color 02

**PASSEPARTOUT** Ottomans in Leather Stonewash color Light Grey, in Nabuk color Stone, in DEDAR Fabric More is More color 02 and Fabric Villa Flori color 02

**DISEGNO** Carpet color Mineral Black

**SPLENDIDO** Carpet color Antracite





10:30 am NAPOLI \_ Italy





L'individuo si sente davvero bene solo quando ha la possibilità di esprimersi al meglio, quando cioè può dispiegare liberamente le sue idee e i suoi desideri. Lo stile, l'architettura, gli ambienti di vita devono essere plasmabili e personalizzabili a misura di individuo perché ne possiamo godere appieno. L'ottoman componibile **Passepartout** offre infinite possibilità di scelta nei rivestimenti e massima libertà compositiva. You feel really good only when you have the opportunity to express yourself at best, that is when you can freely unfold your ideas and your desires. Style, architecture and living environments must be customizable for your needs to let you fully enjoy them. **Passepartout** modular ottoman offers endless possibilities of choice in the upholsteries and maximum freedom in combining all its elements.



**PASSEPARTOUT** design: Giorgio Ragazzini



"Il virtuosismo che caratterizza l'arte del ricamo e ha reso noto il made in italy nel panorama della moda è la fonte di ispirazione per personalizzare e reinterpretare il mondo di Prianera con una collezione di ricami esclusivi". **Giorgio Ragazzini**

"The typical virtuosity of the embroidery art which made the Made in Italy famous in the fashion scene is the source of inspiration which let you customize and reinterpret the Prianera world through an exclusive embroidery collection". **Giorgio Ragazzini**

## EXCLUSIVE EMBROIDERY

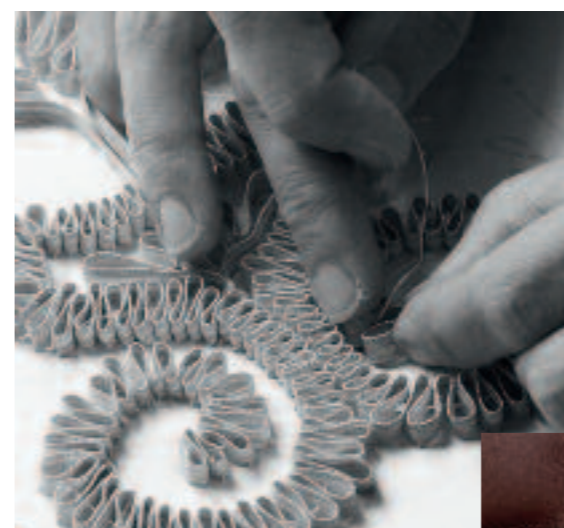

Oltre all'autenticità e qualità dei materiali, nel prodotto confluisce l'entusiasmo di coloro che ogni giorno lavorano con cura e maestria per rendere i prodotti unici e speciali, anche attraverso l'utilizzo dei **ricami esclusivi** che aggiungono ricercatezza al mood contemporaneo Prianera.

In addition to the authenticity and quality of the materials, the product features the enthusiasm of the skillful people who work every day with care to create unique and special products, even through the **exclusive embroideries** that add a unique refined touch to the contemporary Prianera mood.



Personalizza i modelli Prianera con le **tue iniziali** su pelle o su tessuto. Scegli il rivestimento, il colore del ricamo e dove posizionare le iniziali.

Customize Prianera models with **your initials** on leather or fabric. Choose the upholstery, the color of the embroidery and where to place your initials.

## MAKE IT YOURS



due iniziali in Corsivo oppure in Maiuscolo si possono posizionare al centro del bracciolo o al centro del cuscino di schienale  
two capital initials or in italics can be placed in the middle of the armrest or in the middle of the back cushion

La creatività e la libertà progettuale dei designer che collaborano con Prianera trovano un prezioso completamento nella preparazione tecnica del reparto sviluppo prodotti, dove nulla viene lasciato al caso: ogni singolo modello viene sviluppato tenendo conto di parametri e misure che sono il frutto di una lunga esperienza. La **modularità** e le **dimensioni** dei vari modelli, delle poltrone e dei complementi sono garanzia di comodità e comfort assoluti.

The creativity and the project liberty of designers that work with Prianera find a precious completion in the technical planning of R&D department, where nothing is left to chance, every single model is developed considering parameters and measures that are the result of a long experience. The **modularity** and **dimensions** of various models, chairs and components are the guarantee of absolute comfort.

## CARPETS



SETOSO Carpet



Bianco\_Avorio 01

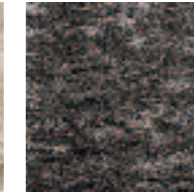

Avorio\_Nero 04



Beige\_Marrone 02

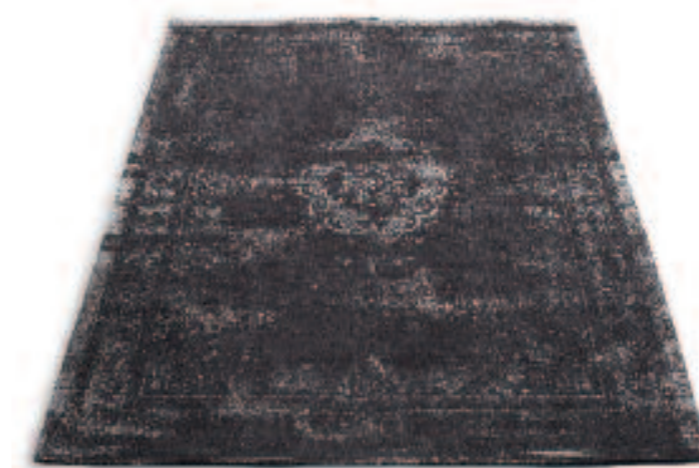

DISEGNO Carpet



Blue Night



Grey Ebony



Mineral Black



SPLENDIDO Carpet \_ bordo in filo tono su tono



Avorio



Beige



Nocciola



Argento



Cipria



Cenere



Moro



Antracite

La prima cifra indica i **centimetri**, la seconda cifra indica i pollici

Le misure dei ns. prodotti, essendo realizzati a mano, si intendono indicative, pertanto è ammessa **una tolleranza nei limiti massimi del 3%**.

The first figure shows the sizes in centimeters, the second in **inches**.

Being our products handmade, their dimensions are to be considered approximate, therefore a maximum **tolerance of 3% is allowed**.

OPZIONI BORDO in filo  
per Splendido Carpet  
PIPING OPTIONS  
for Splendido carpets

Burro



Moro



Panna



Rosso



Tortora



Pepe



Nocciola



Cenere



Castoro



Pavone



Senape



Antracite



## MARBLE

CALACATTA

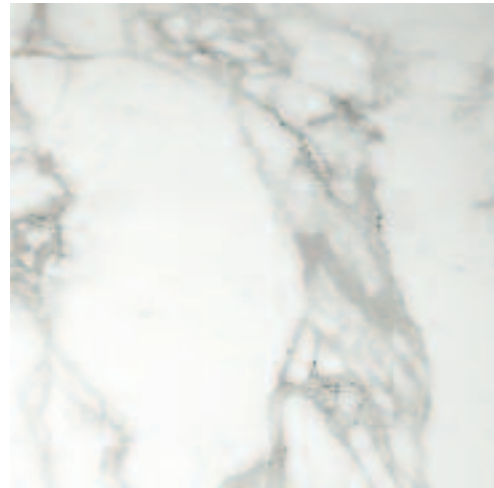

PORT LAURENT

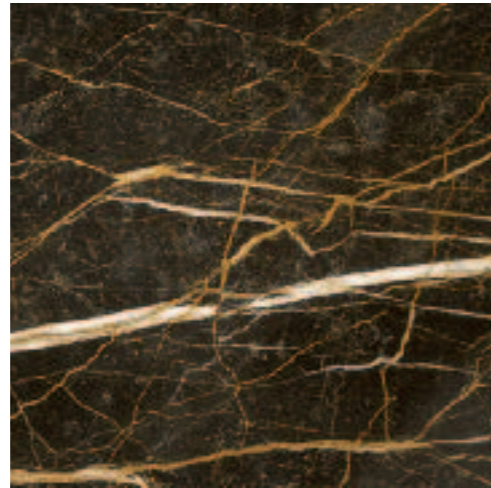

ONICE TANZANIA

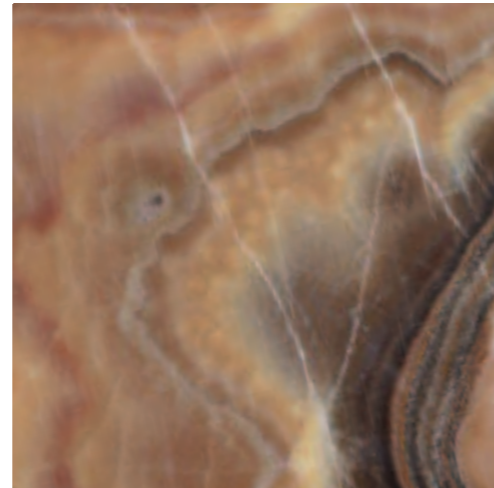

## METAL

finitura CHROME



finitura DARK CHROME



finitura NICKEL



finitura GOLD



finitura BRASS



finitura RUST



finitura MATTE BLACK



finitura RAL 9016



finitura RAL 8022



## WOOD

FAGGIO - BEECH

Naturale



col. Talpa



col. Fumè



col. Tabacco



col. Wengè

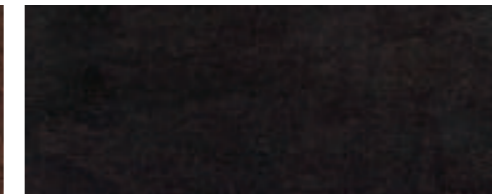

NOCE CANALETTO

Naturale



FRASSINO - ASH

col. Matte Grey



col. Matte Wengè



col. Matte Honey



col. Shining Grey



col. Shining Wengè

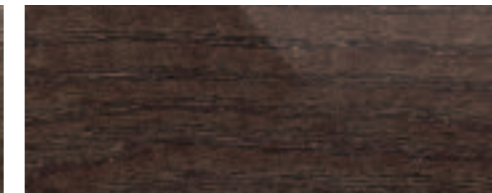

col. Shining Honey



**ALFRED** design Carlo Bimbi

p. 106

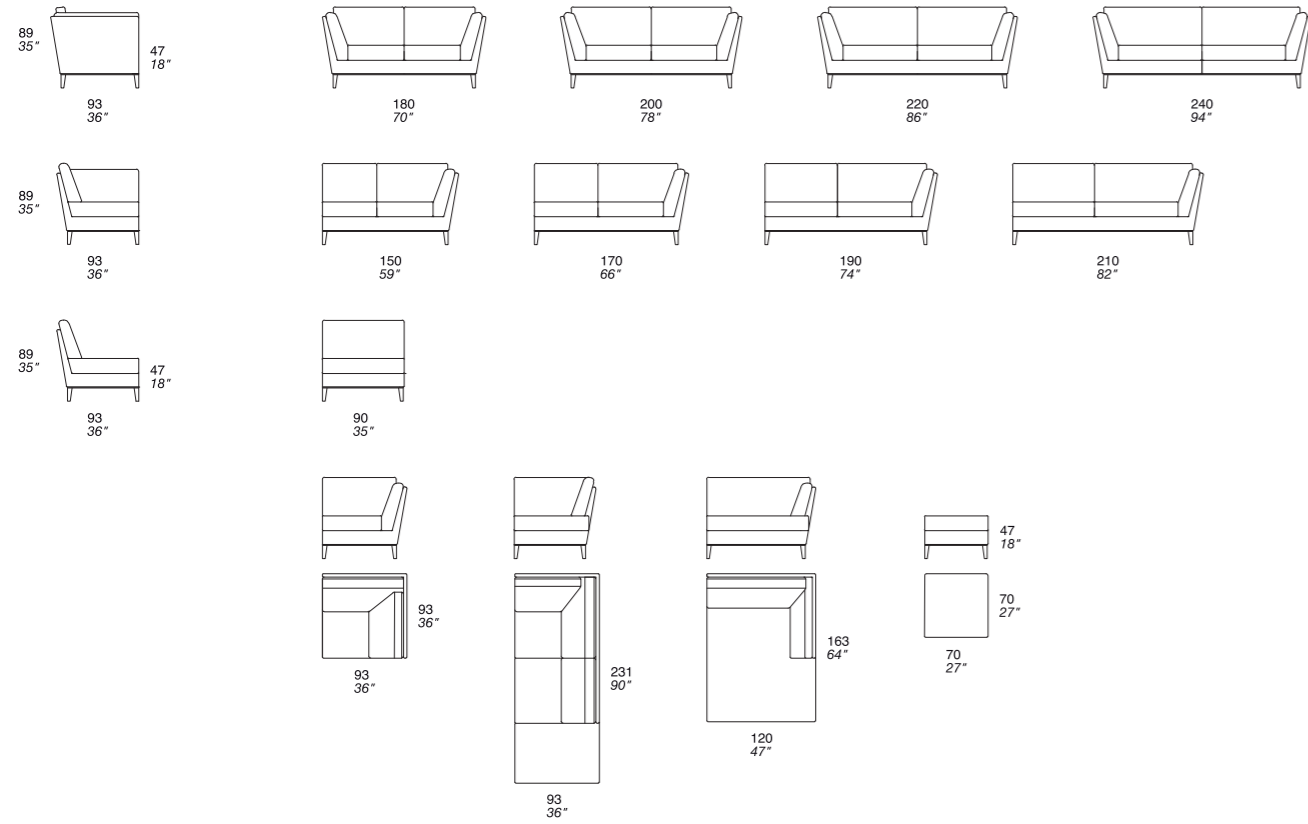

**MIVIDA** design Angelo Tomaiuolo

p. 38

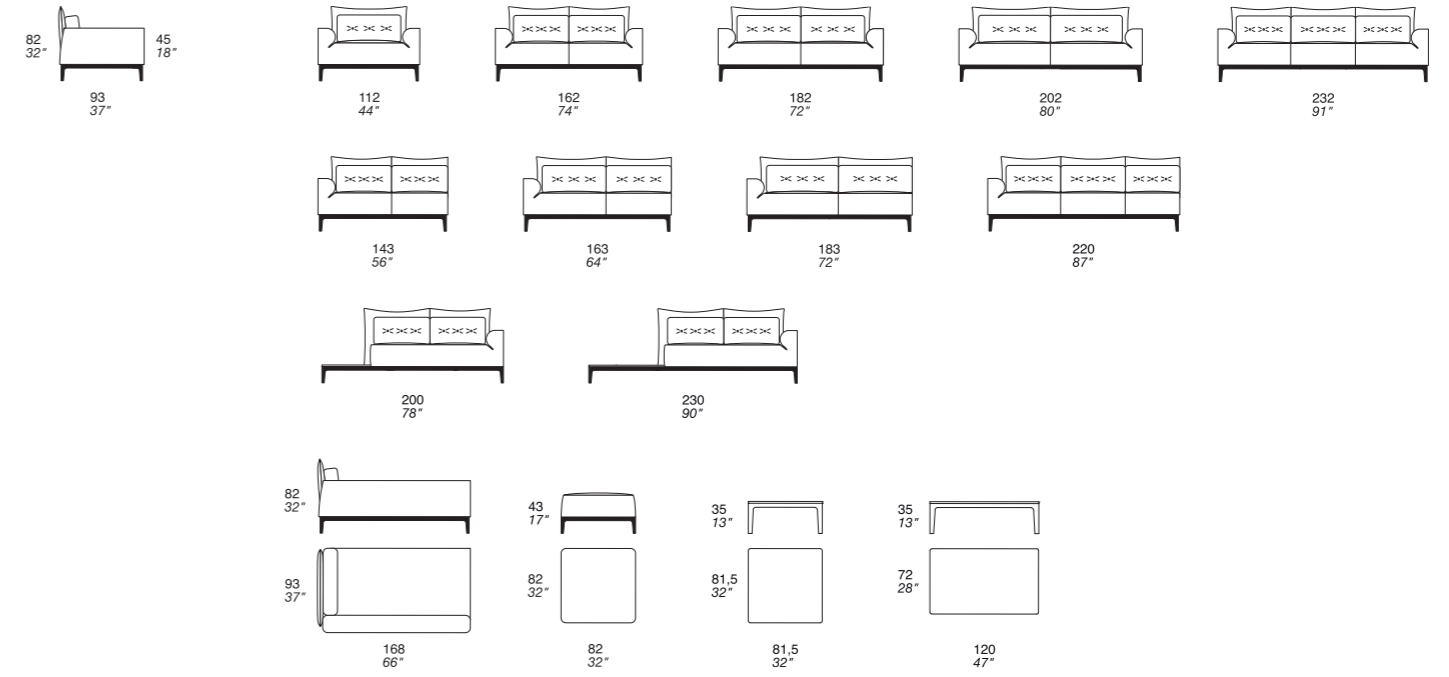

**BOHEME** design Style Department Prianera

p. 86

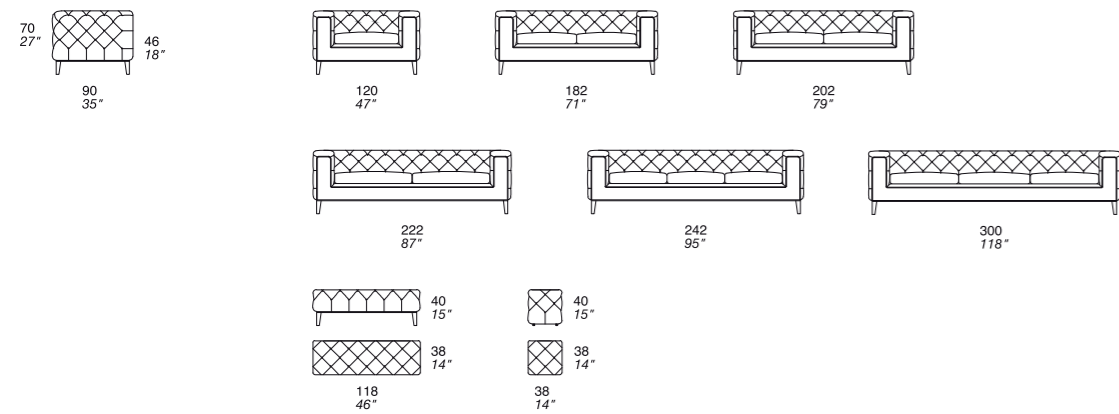

**NABUCCO** design Style Department Prianera

p. 122

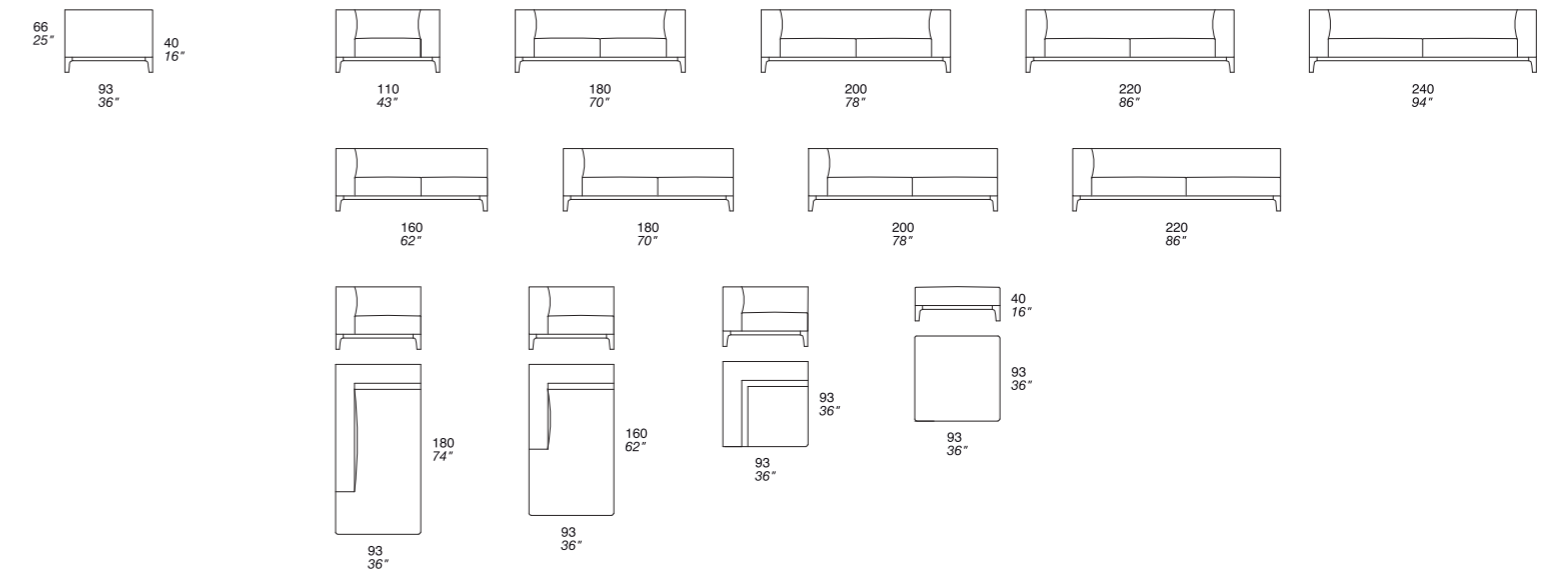

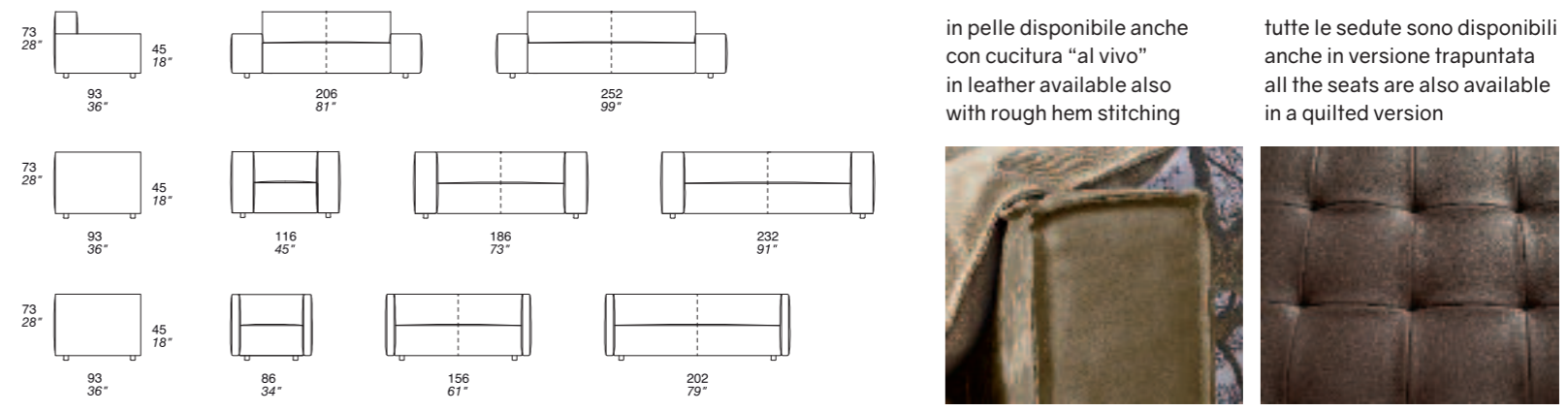
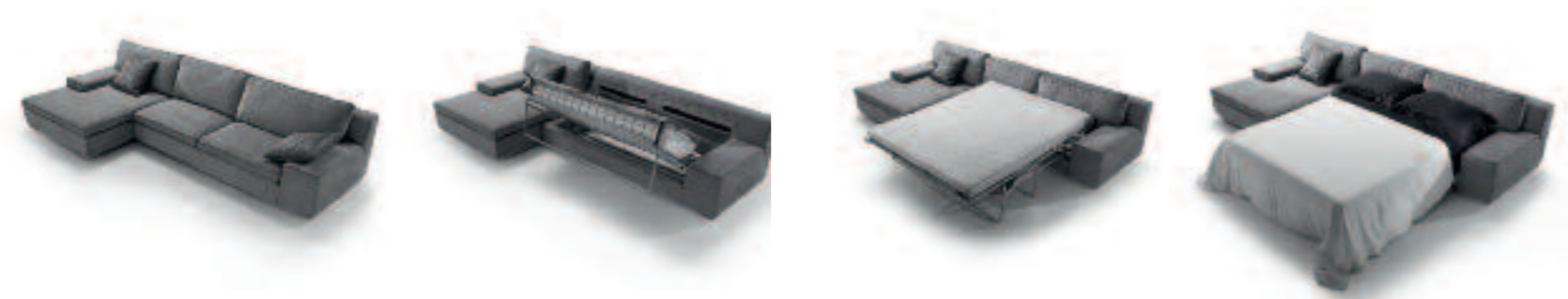
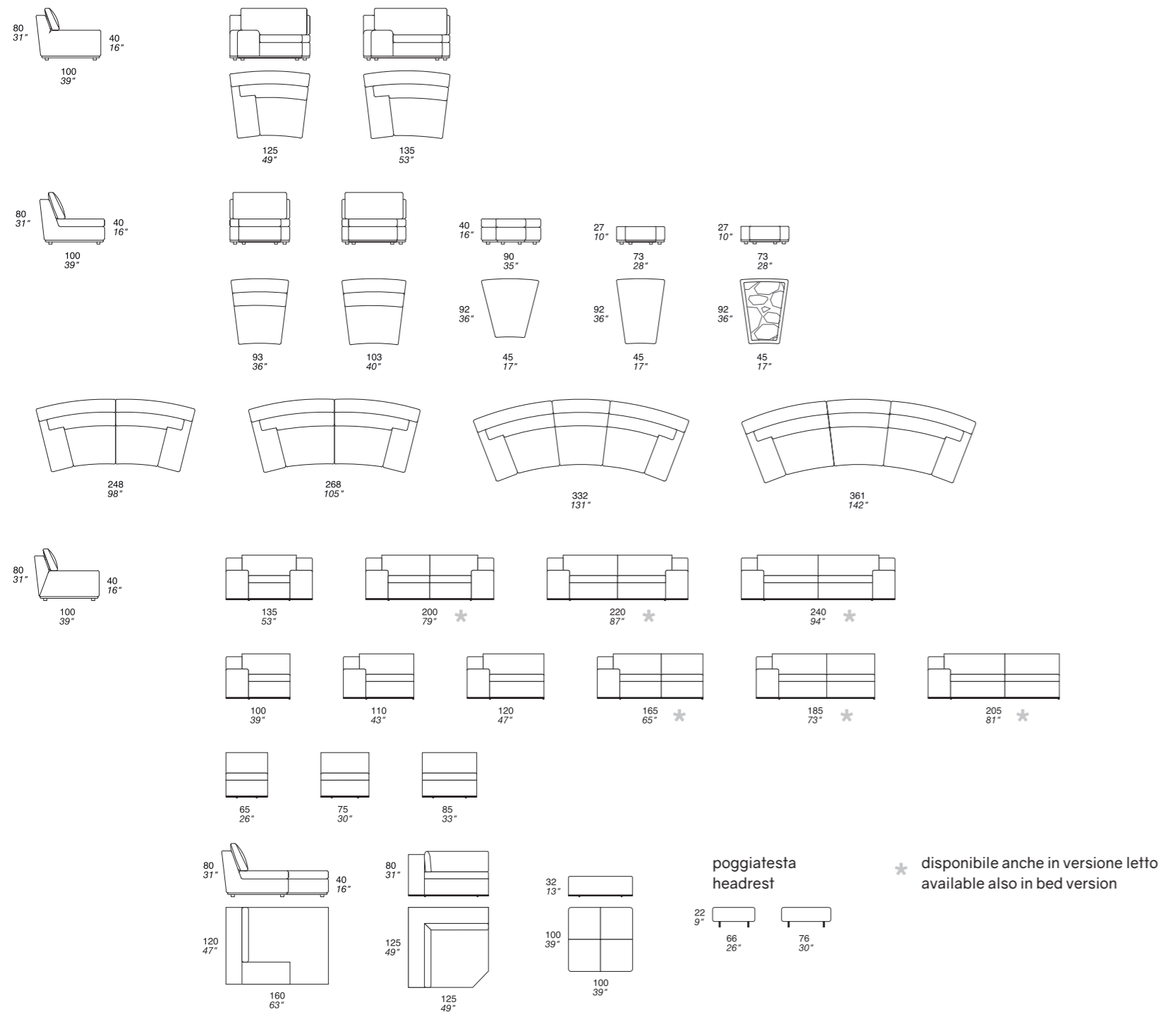

in pelle disponibile anche con cucitura "al vivo" in leather available also with rough hem stitching

tutte le sedute sono disponibili anche in versione trapuntata all the seats are also available in a quilted version



bracciolo grande big armrest



bracciolo medio medium armrest



bracciolo piccolo small armrest



tutti gli elementi componibili sono disponibili con i 3 braccioli all modular elements are available with all the 3 different armrests

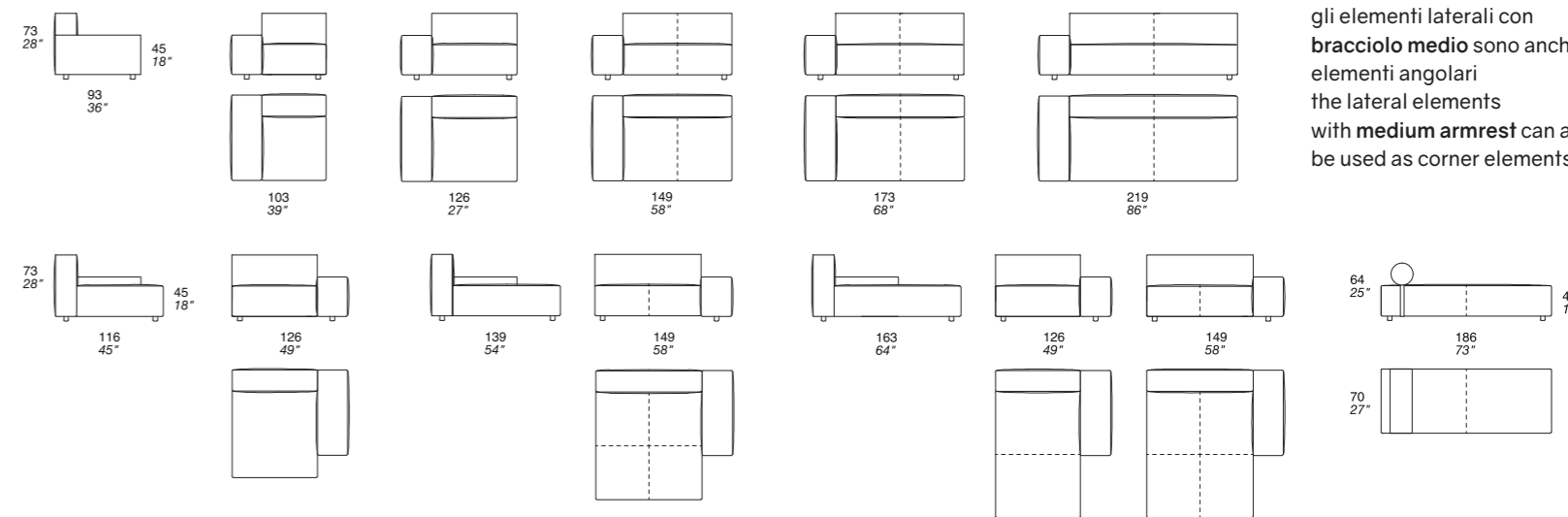

gli elementi laterali con bracciolo medio sono anche elementi angolari the lateral elements with medium armrest can also be used as corner elements

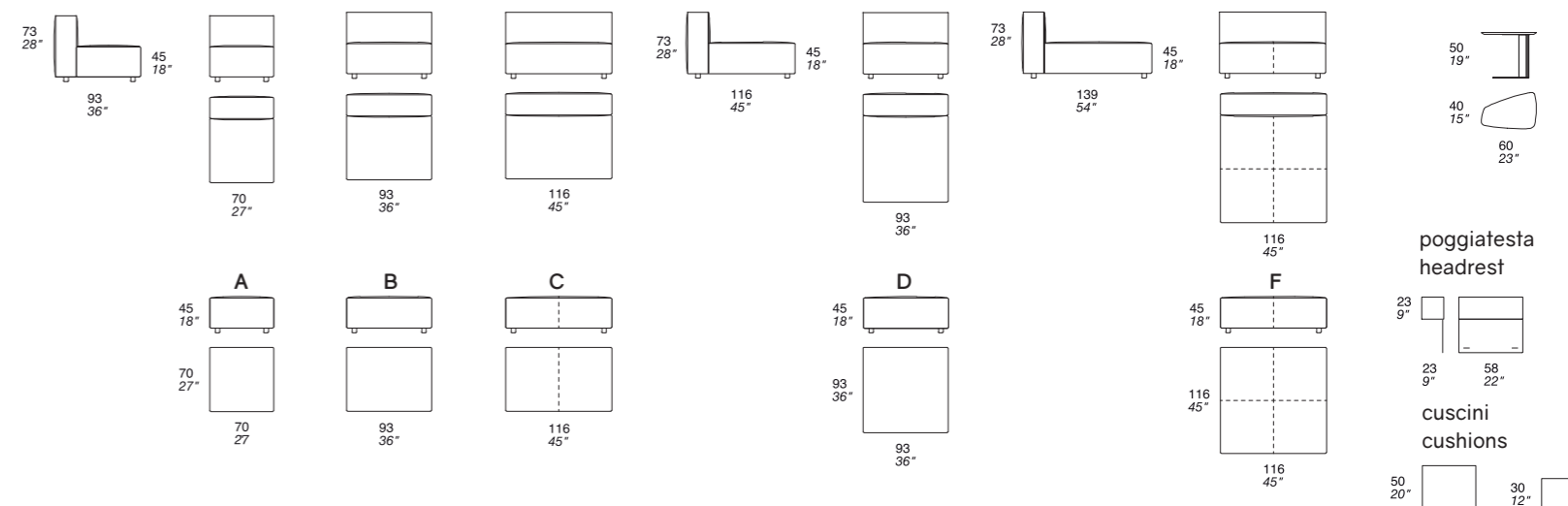

poggiatesta headrest

cuscini cushions



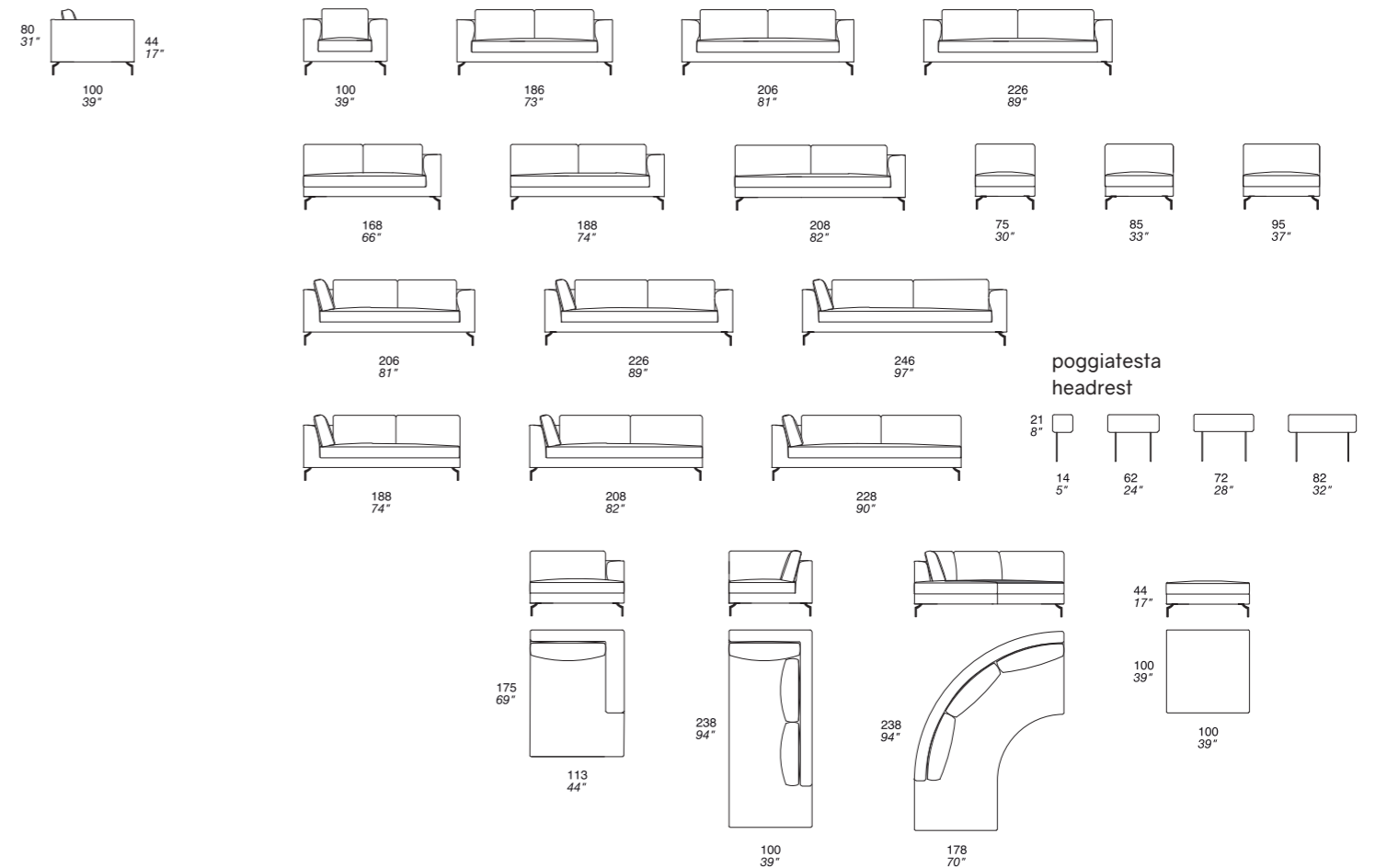
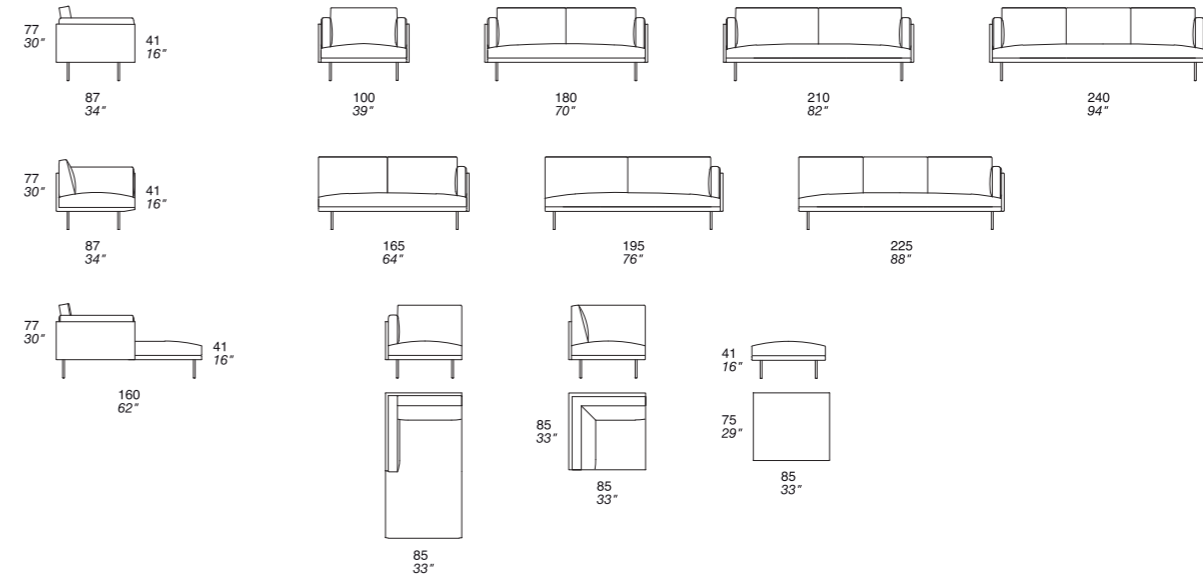
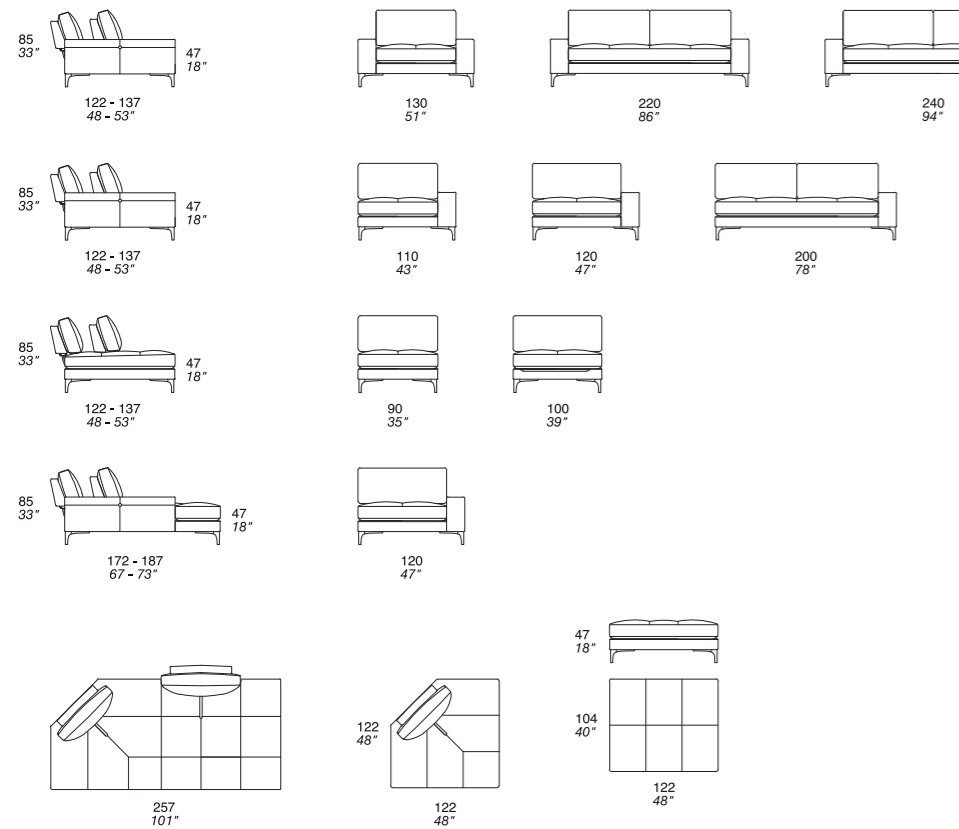
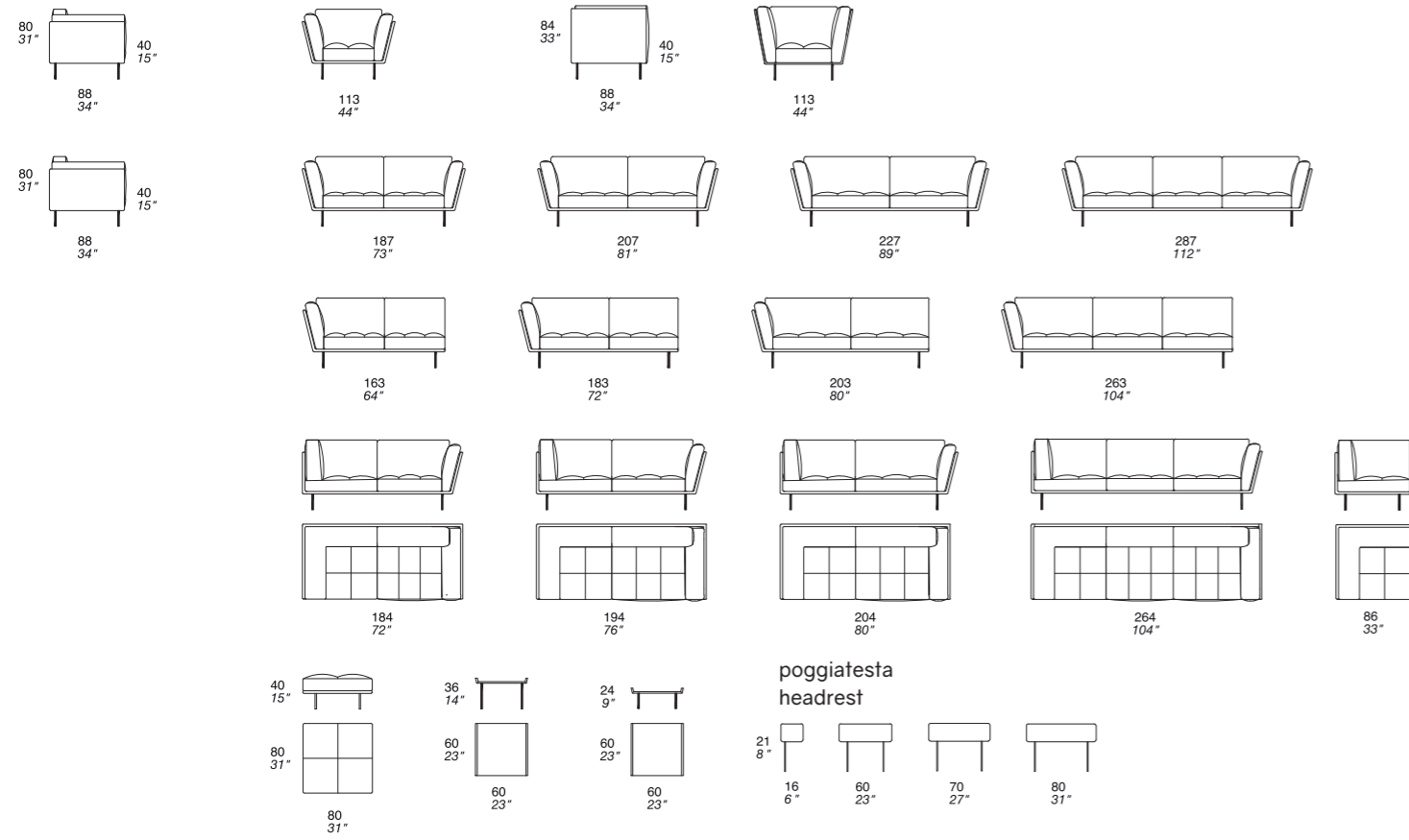

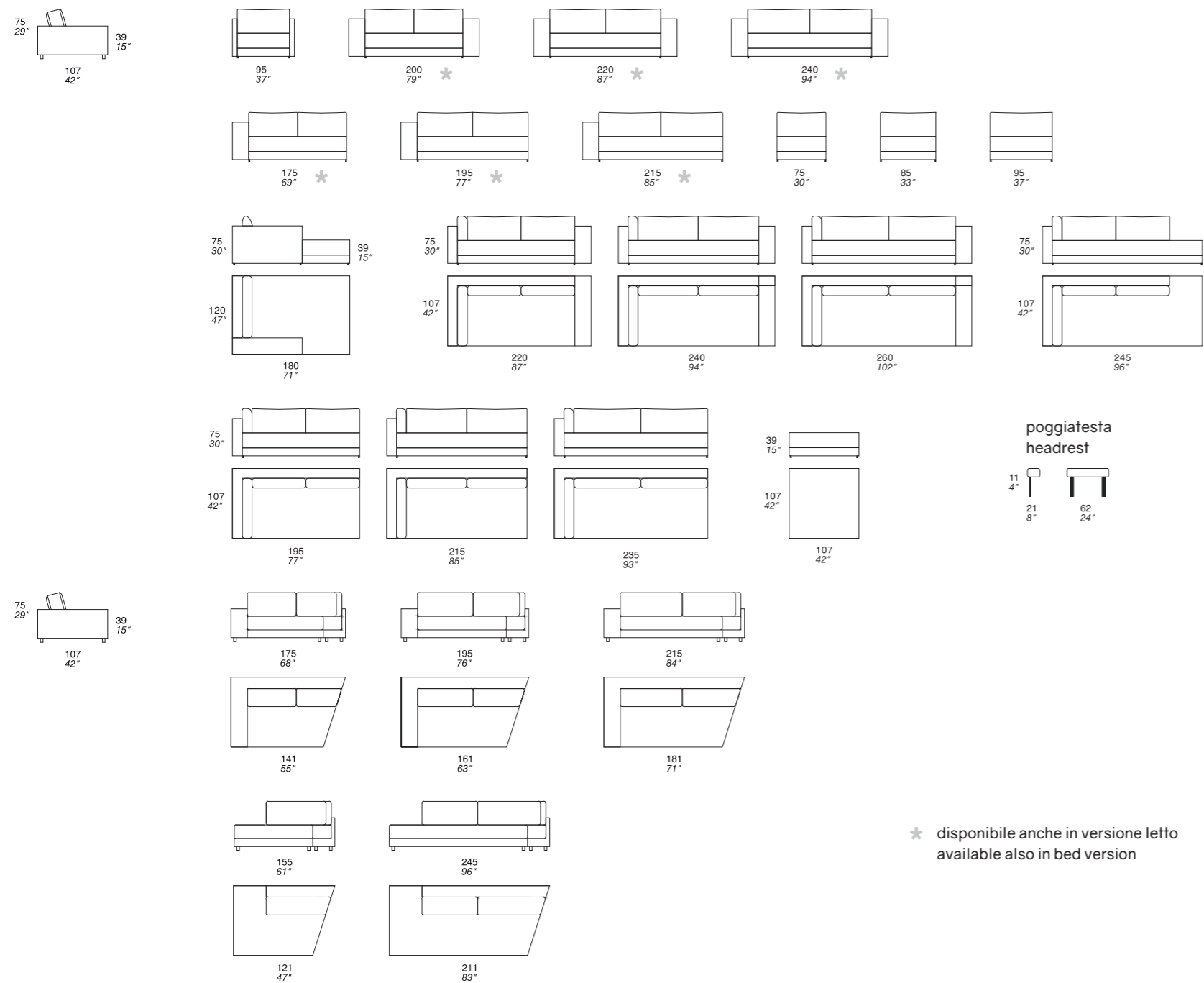

\* disponibile anche in versione letto  
available also in bed version

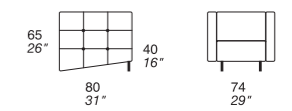
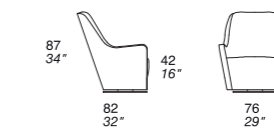
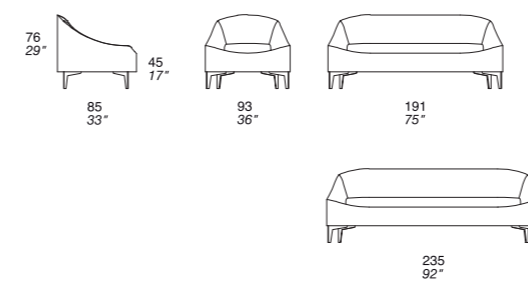

PASSEPARTOUT MODULAR OTTOMANS design Giorgio Ragazzini

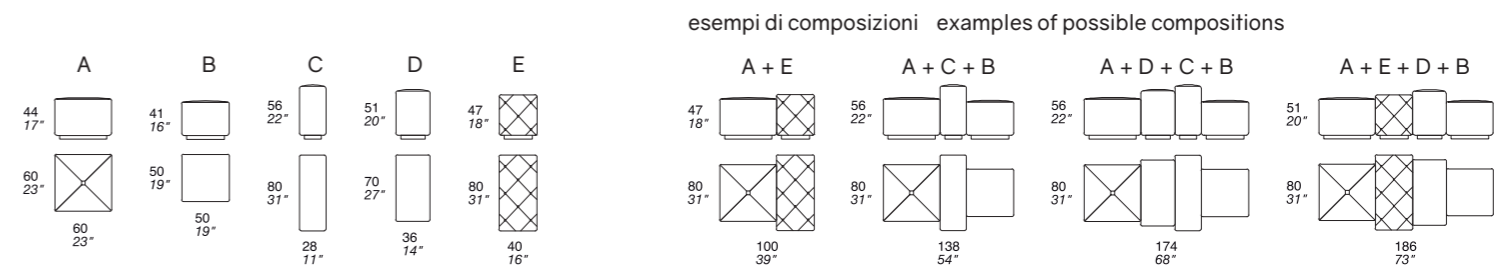

esempi di composizioni examples of possible compositions

ALADINO design Style Department Priarera

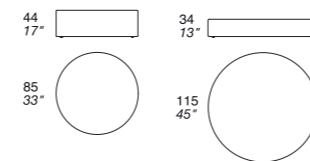

MEDEA design Giorgio Ragazzini

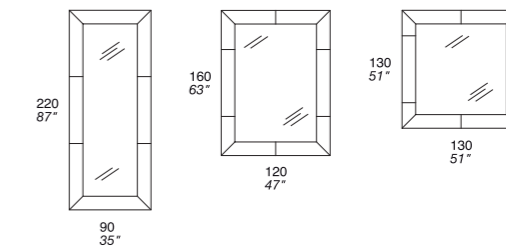

GAVI

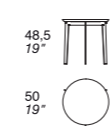

VENTOTENE

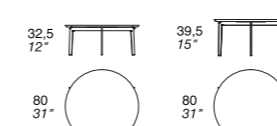

GIGLIO

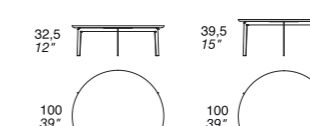

CAPRI

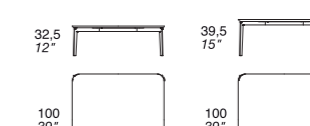

ISCHIA design C. Bimbi

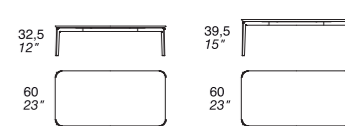

ABACO design Style Department Priarera

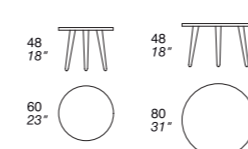

TRIAL design Carlo Bimbi

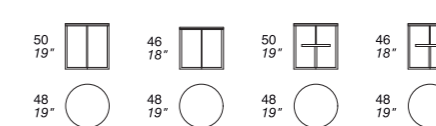

OUVERTURE design Giorgio Ragazzini

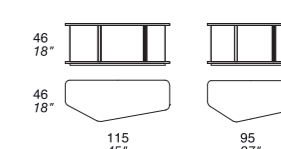

## COLOPHON

Project coordination **Andrea Rasi**

Art Direction and Graphic **Studio Giorgio Ragazzini**

Photography **Studio Aeroplano - Giovanni Collina**

Prepress **Studio 59 Prepress**

Print **Modulgrafica forlivese**

L'azienda si riserva di apportare modifiche che ritiene più opportune ai prodotti, in qualsiasi momento e senza preavviso.

Alcuni accessori presenti nelle immagini fotografiche non sono prodotti dalla ditta Polaris designed for living, si prega di far sempre riferimento al listino prezzi. È vietata ogni riproduzione totale o parziale in Italia e all'estero.

Polaris designed for living reserves the right to modify models and dimensions without any previous notice.

Some accessories present in the photographs are not produced by Polaris designed for living, please refer to price list.

Total or partial reproduction prohibited in Italy or any other country.



PRIANERA®