

DESIGN **ROBERTO GIACOMUCCI**

BIGALA



Bigala nasce da una riflessione sul confine tra interno ed esterno, tra funzione ed evasione, tra riservatezza ed esteriorità. Bigala può anche essere attrezzato con punti di ricarica per i dispositivi mobili e con un tavolino sul quale appoggiarsi per lavorare. Bigala si sviluppa su una struttura portante in ferro che plasma la sua forma contenitiva, caratterizzata da due ali che racchiudono e proteggono, creando privacy per il singolo o un angolo conversazione riservato.

- 1 - fibra di dacron® 100 gr;
- 2 - poliuretano espanso indeformabile di diverse densità;
- 3 - telaio in multistrato di legno;
- 4 - struttura in metallo verniciato;
- 5 - cinghie elastiche intrecciate;
- 6 - telaio in multiflex di legno;
- 7 - telaio in multiflex e multistrato di legno.

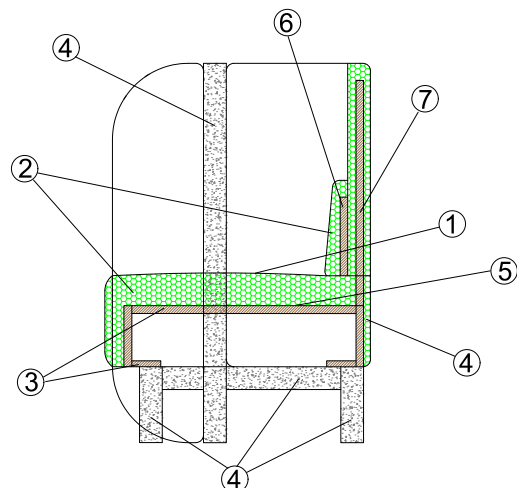

DIMENSIONI:

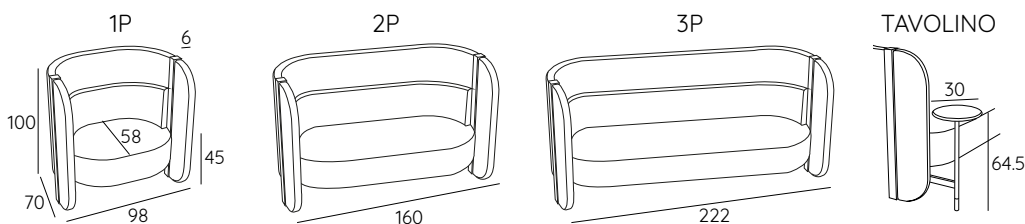

BASE:



COLORI STRUTTURA E TAVOLINO:

RAL su richiesta

BIGALA

DESIGN **ROBERTO GIACOMUCCI**

DEVICES:

USB



Alimentazione 230 V.
Due prese USB
Voltaggio differente
su richiesta.

SCHUKO



Presse elettrica schuko.
Alimentazione 230 V. Presse
elettrica UK
e USA su richiesta.

INFORMAZIONI TECNICHE:

Sfoderabile: NO	kg	m ³	mts
BIGALA 1P	/	0.68	(1) 2.50 (2) 6.00 (3) 5.00 (4) 2.50
BIGALA 2P	/	1.12	(1) 2.50 (2) 7.00 (3) 6.00 (4) 3.50
BIGALA 3P	/	1.55	(1) 2.50 (2) 8.00 (3) 7.00 (4) 4.50

1P

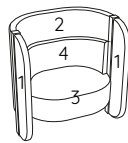

2P

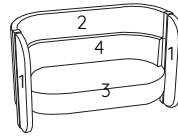

3P



RIVESTIMENTI CONSIGLIATI:



Lemming 29500



Luna/Z CS



Amara

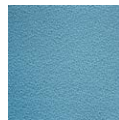

Mirage



Sprint

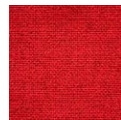

Sole CS



Nemi melange



Angel combo



Angel chevy



Angel jumbo



Europost 2



Natur wool

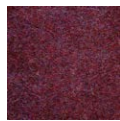

Fenice



Vintage



Tiffany contract



Polaris Pro



Happy



Parasol 100

PHOTO GALLERY:



Bigala poltrona



Bigala divano 3 posti con tavolino