B&B Atoll

SOFAS

Antonio Citterio



Description

B&B Atoll, новая модульная система сидений Антонио Читтерио, чье название ассоциируется с одноимённым коралловым образованием, - это изысканное выражение сбалансированной эстетической формы и решительного и в то же время чрезвычайно элегантного современного стиля. Отправной точкой системы являются три платформы основания - 190 см и 240 см с глубиной 90 см, 130 см с глубиной 140 см, которые комплектуются подлокотниками и спинками для формирования различных типов: диваны кабины, дюрмез, угловые терминальные элементы, отдельные или модульные элементы с шезлонгами и пуфами. Конструкции легких и утонченных линий нанесены на отлитые под давлением высокие опоры с металлическими профилями, выделяющими линию между самими конструкциями и набивкой; предусмотрены два вида отделки - олово и черный хром. В дополнение предлагается характерный элемент, который смещается по необходимости: подушка-

валик двух размеров - 65 см и 90 см - соединенная с отлитой конструкцией кожаными ремнями. Аксессуар, размещаемый произвольно между подушкой сиденья и конструкцией основания, служит дополнительной опорой и может стать на выбор как подлокотником, так и спинкой. V&V Atoll показывает себя динамичным проектом, с новым уровнем адаптации композиции и с возможностью создания многочисленных типов сидений, от более неформального для отдыха до самых официальных, благодаря использованию дополнительных подушек спинки.

Technical information

Technical drawings

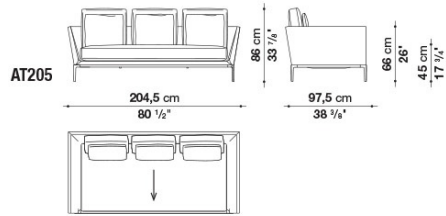

AT205

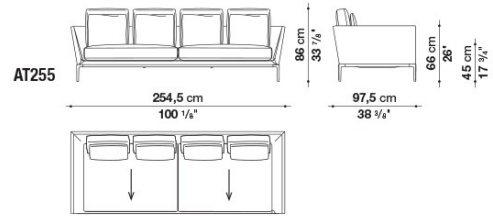

AT255

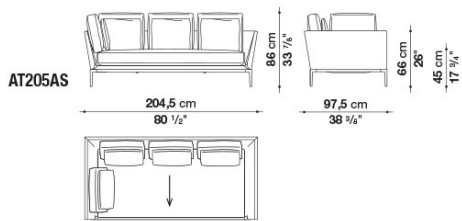

AT205AS

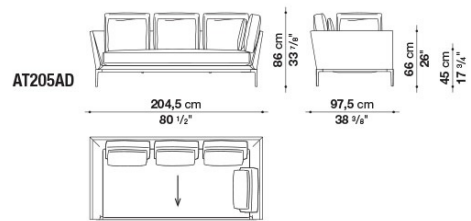

AT205AD

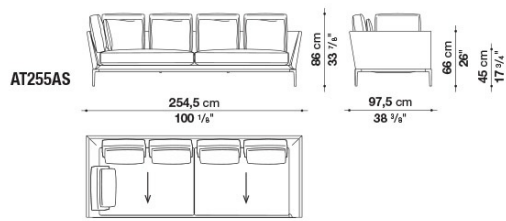

AT255AS

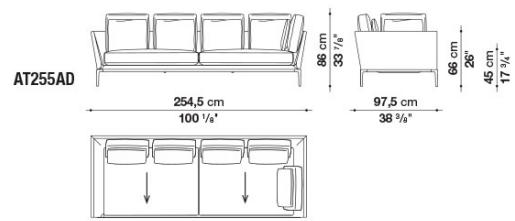

AT255AD

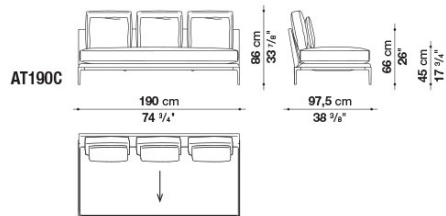

AT190C

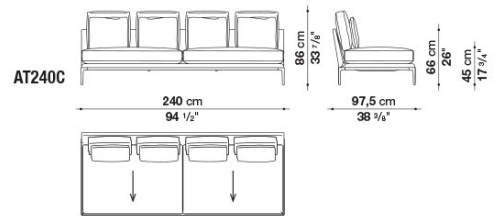

AT240C

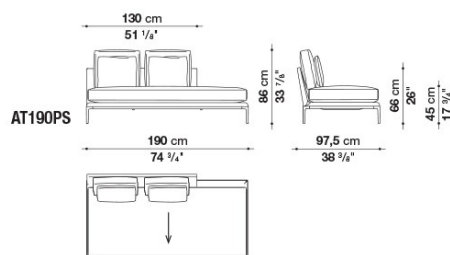

AT190PS

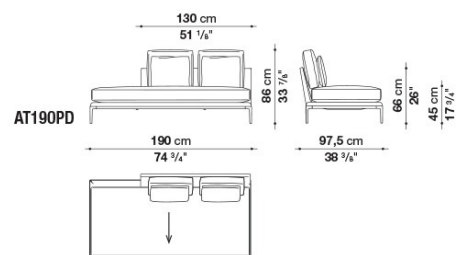

AT190PD

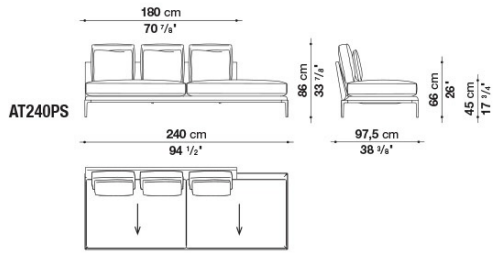

AT240PS

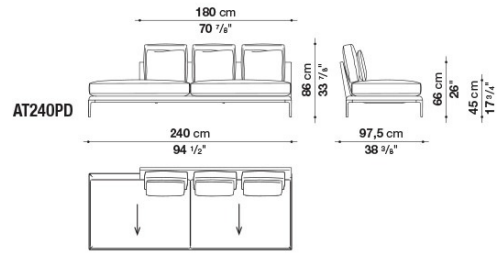

AT240PD

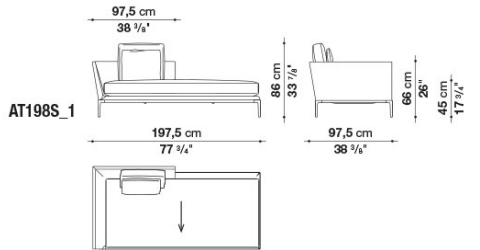

AT198S_1

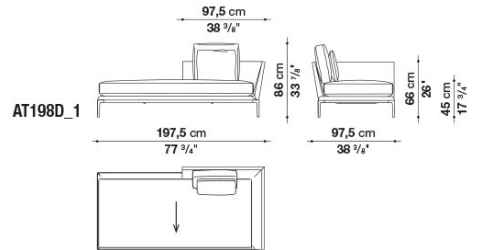

AT198D_1

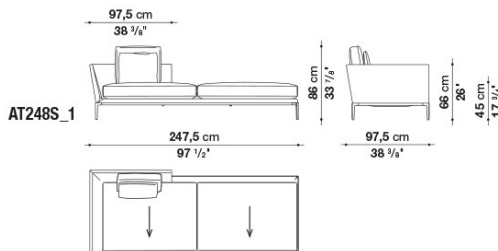

AT248S_1

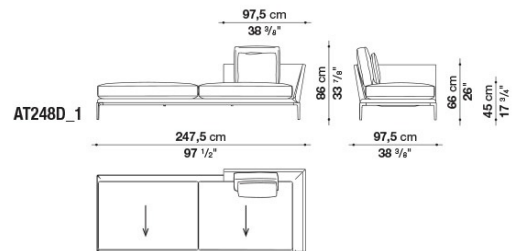

AT248D_1

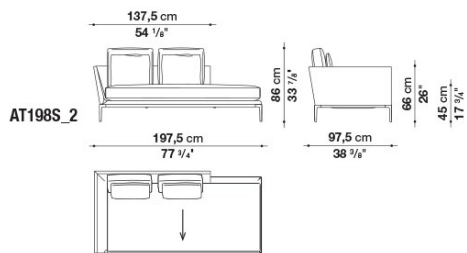

AT198S_2

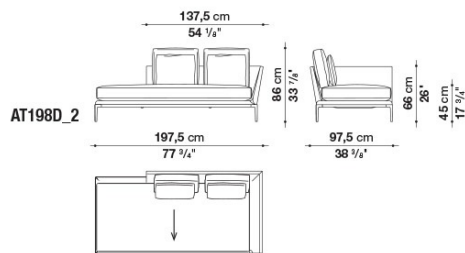

AT198D_2

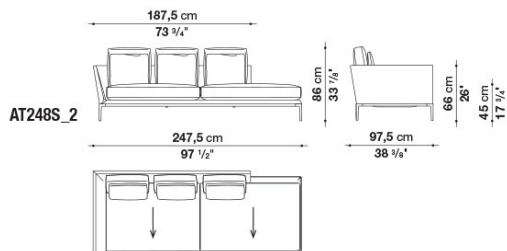

AT248S_2

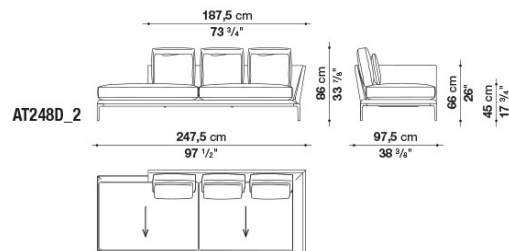

AT248D_2

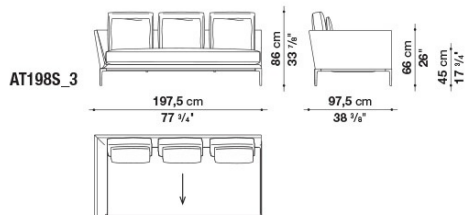

AT198S_3

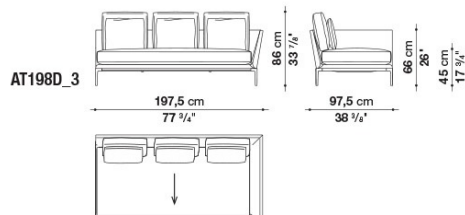

AT198D_3

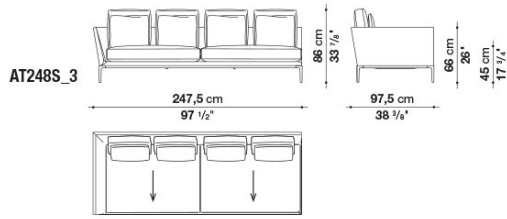

AT248S_3

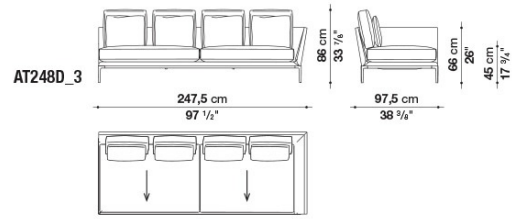

AT248D_3

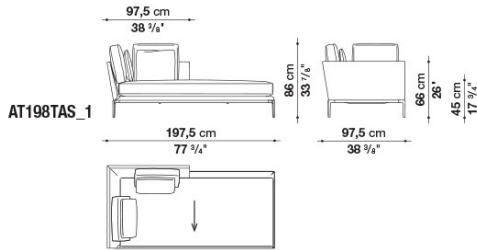

AT198TAS_1

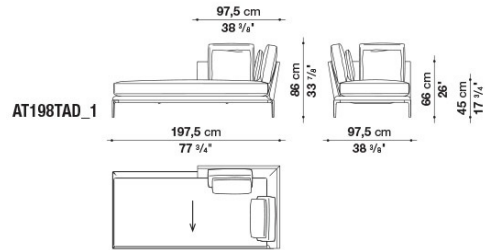

AT198TAD_1

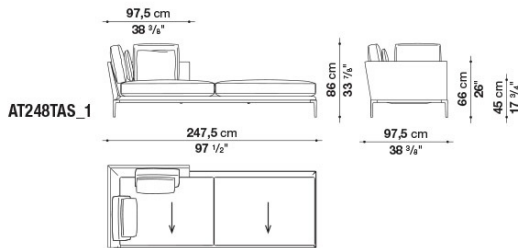

AT248TAS_1

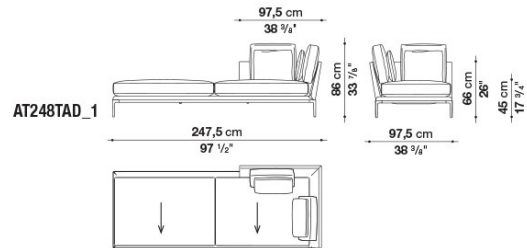

AT248TAD_1

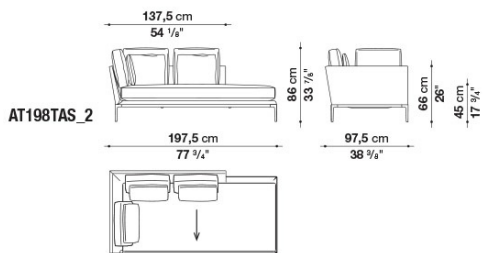

AT198TAS_2

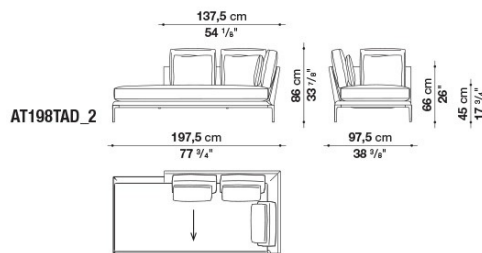

AT198TAD_2

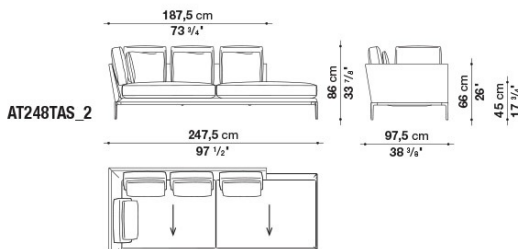

AT248TAS_2

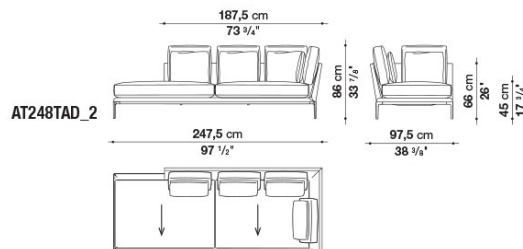

AT248TAD_2

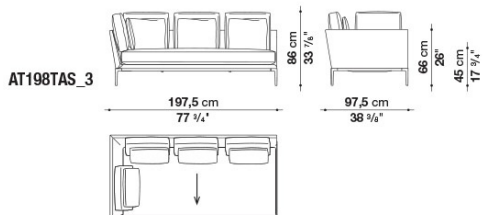

AT198TAS_3

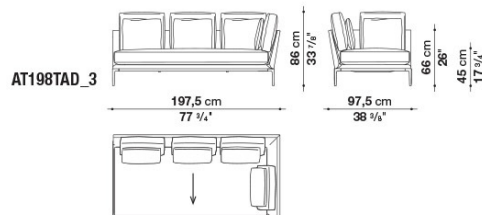

AT198TAD_3

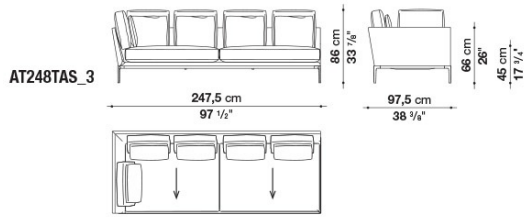

AT248TAS_3

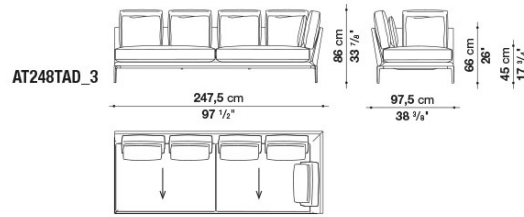

AT248TAD_3

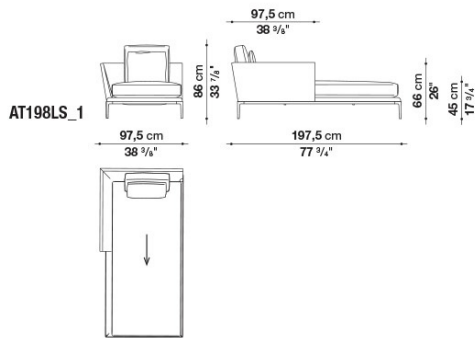

AT198LS_1

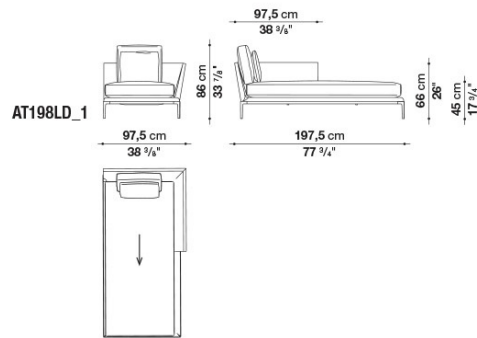

AT198LD_1

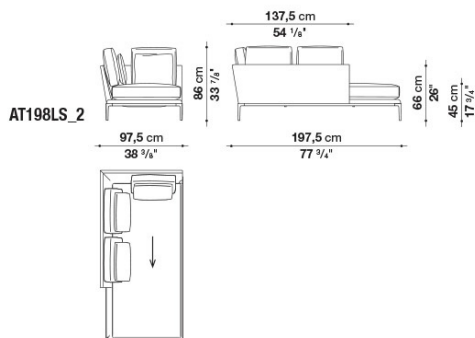

AT198LS_2

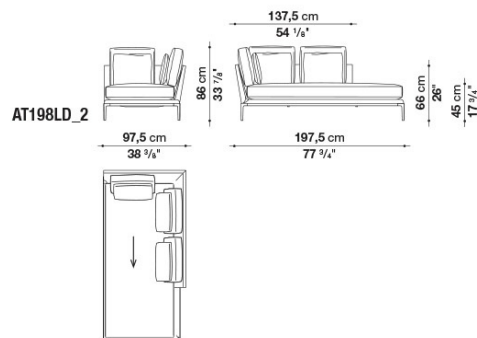

AT198LD_2

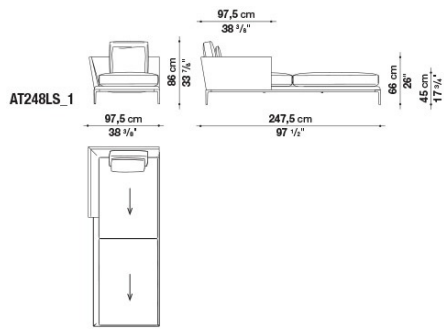

AT248LS_1

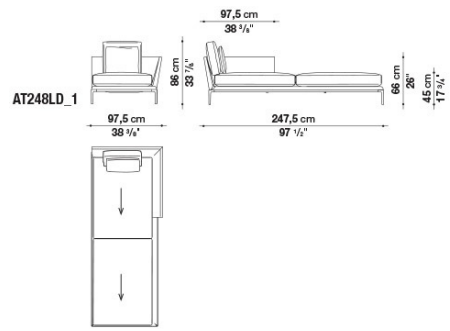

AT248LD_1

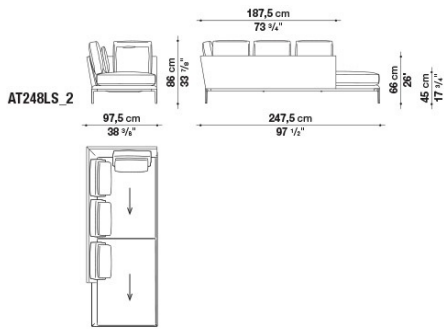

AT248LS_2

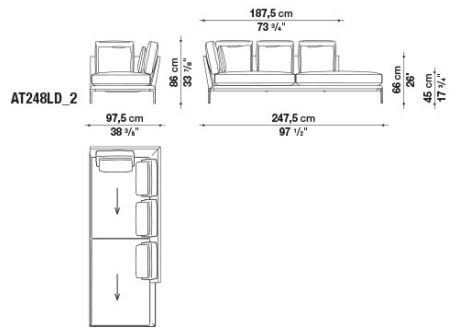

AT248LD_2

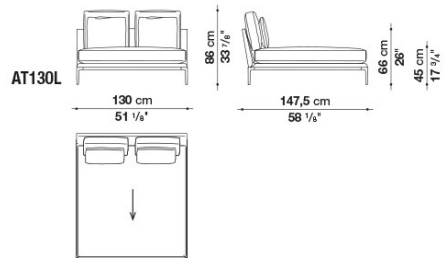

AT130L

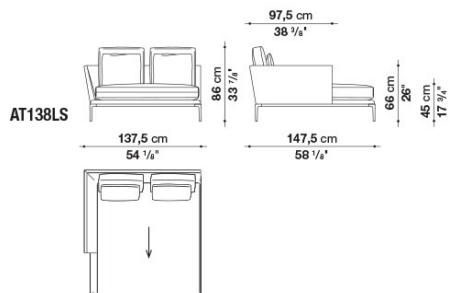

AT138LS

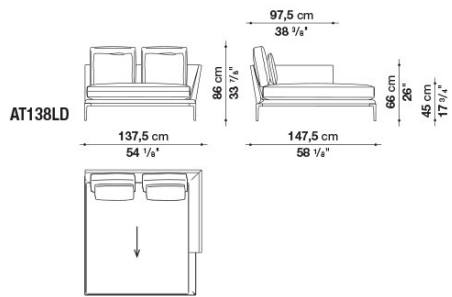

AT138LD

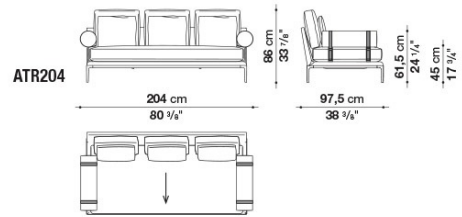

ATR204

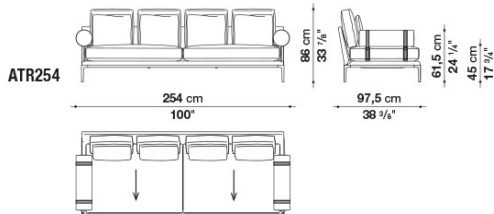

ATR254

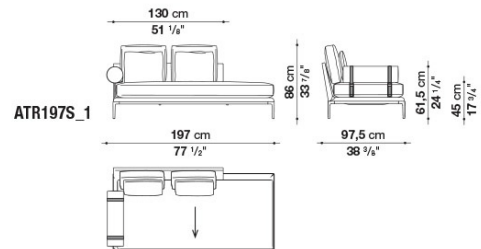

ATR197S_1

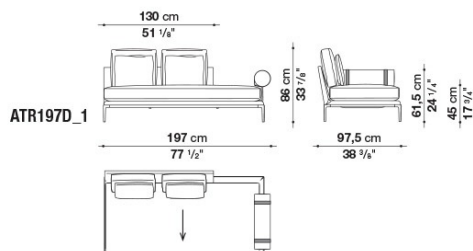

ATR197D_1

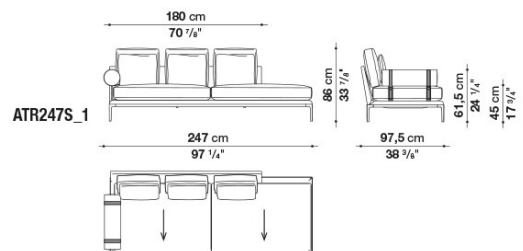

ATR247S_1

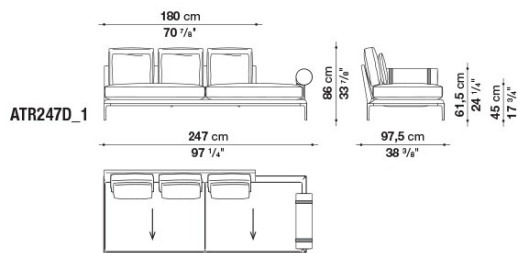

ATR247D_1

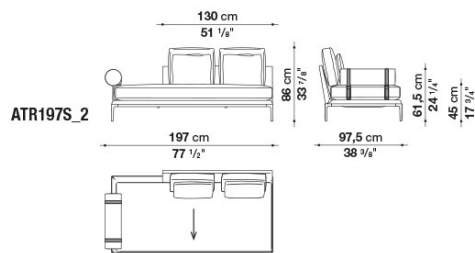

ATR197S_2

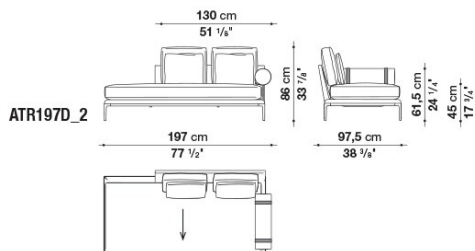

ATR197D_2

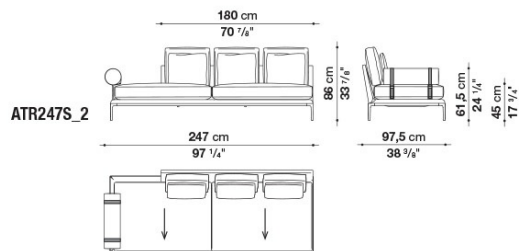

ATR247S_2

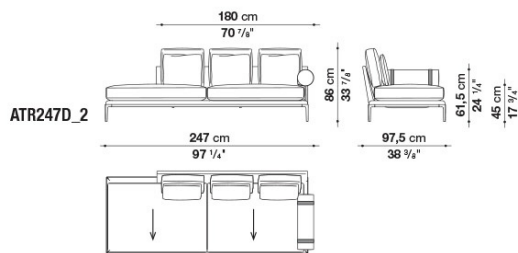

ATR247D_2

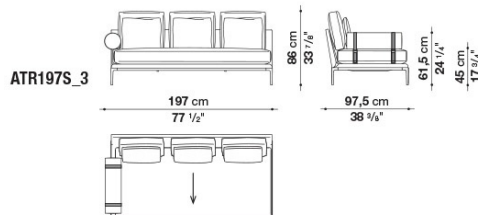

ATR197S_3

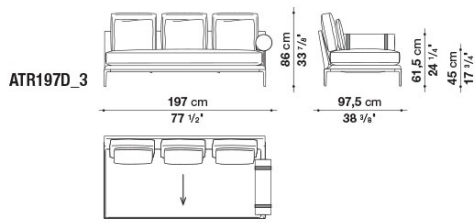

ATR197D_3

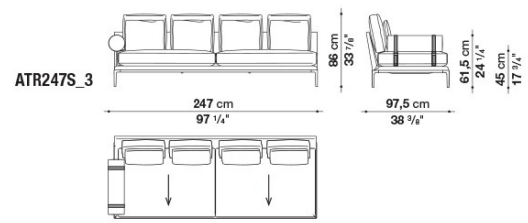

ATR247S_3

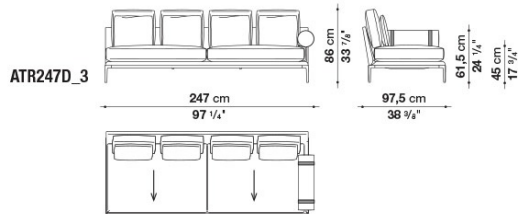

ATR247D_3

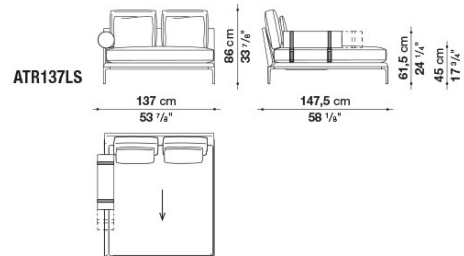

ATR137LS

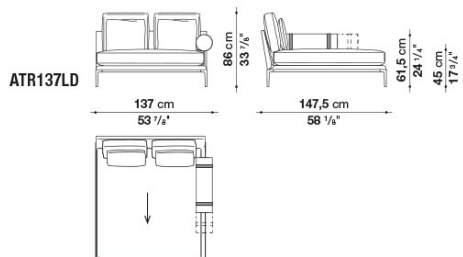

ATR137LD

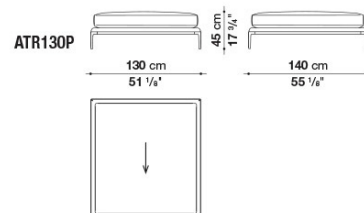

ATR130P

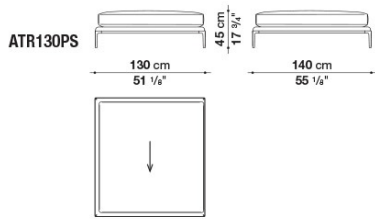

ATR130PS

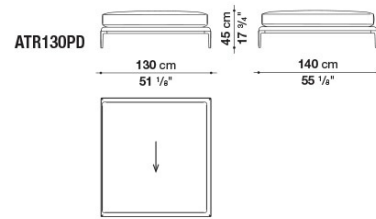

ATR130PD

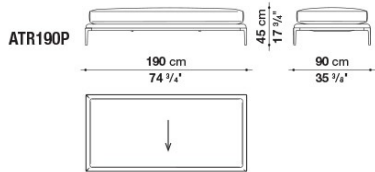

ATR190P

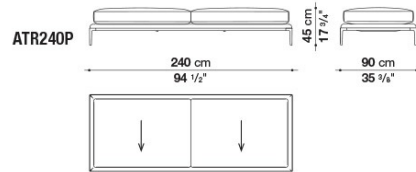

ATR240P

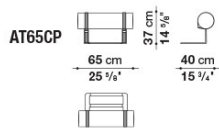

AT65CP

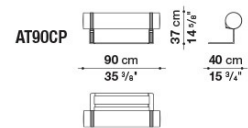

AT90CP

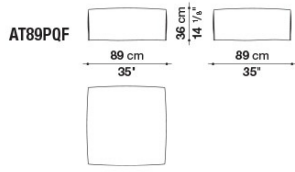

AT89PQF

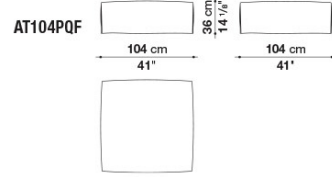

AT104PQF

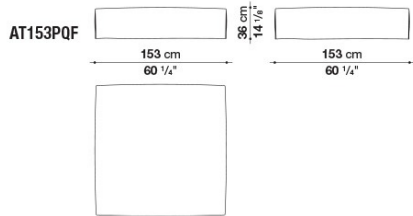

AT153PQF

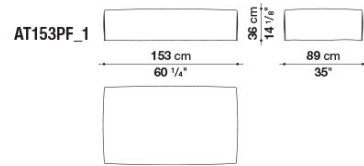

AT153PF_1

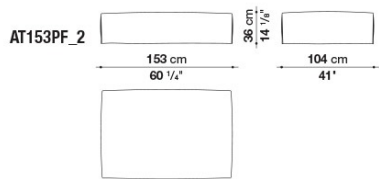

AT153PF_2

Compositions

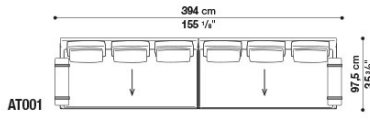

01

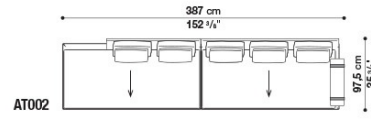

02

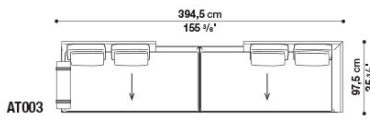

03

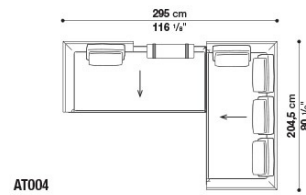

04

AT005

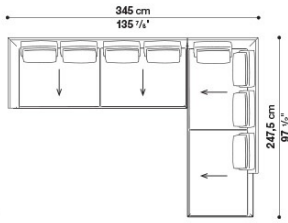

05

AT006

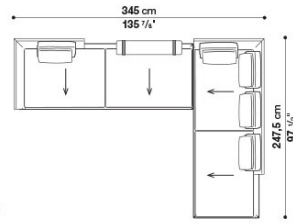

06

AT007

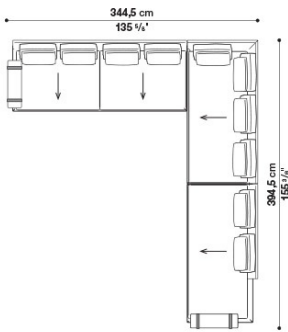

07

AT008

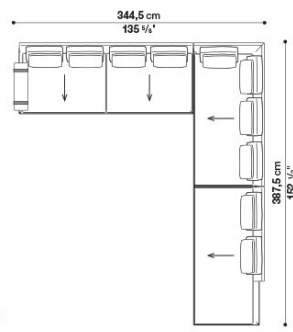

08

AT009

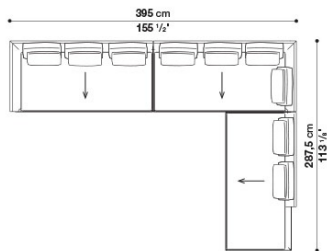

09

AT010

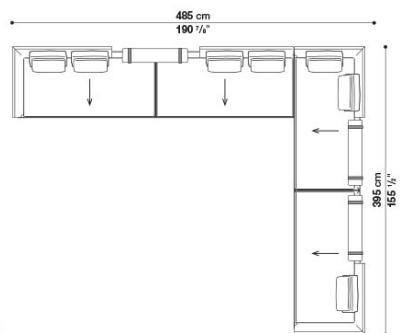

10

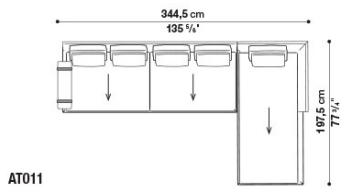

11

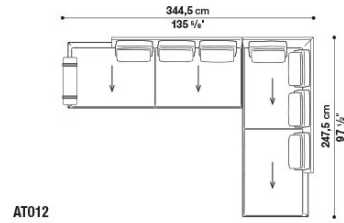

12

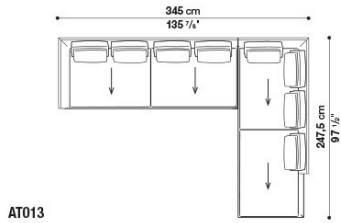

13

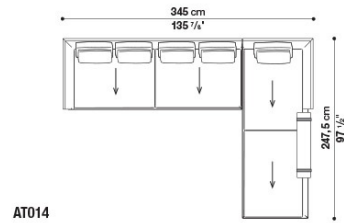

14

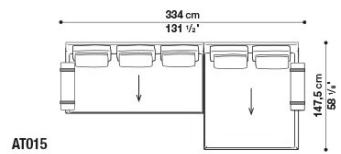

15

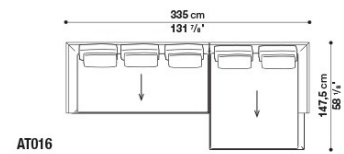

16

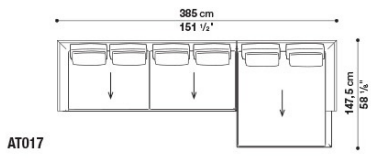

17

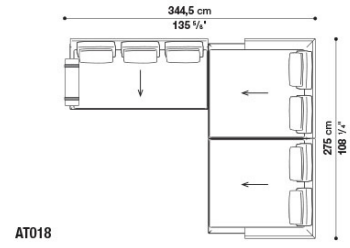

18

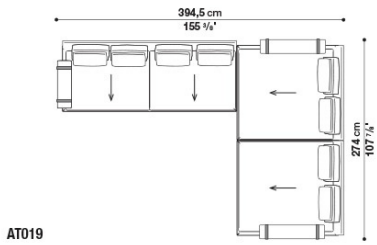

19

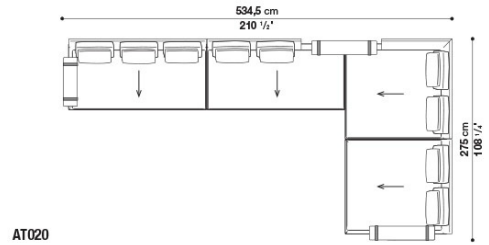

20

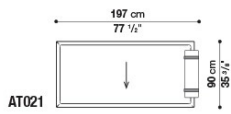

21

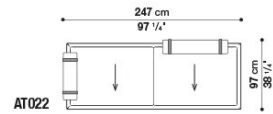

22

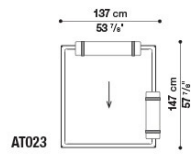

23

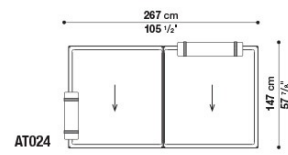

24

B&B Italia reserves the right to make technological and aesthetic improvements to its models, including changes to the sizes and materials, without notice. The technical drawings do not define the details of the product. The measurements shown are indicative and may undergo changes. In particular, the dimensions relevant to the padded parts are subject to usage tolerances over time caused by the normal adjustment of the padding. For the specific information, please contact the dealer closest to you.