Charles

SOFAS

Antonio Citterio



Description

The protagonist of modern lifestyle, it has become the landmark in the world of design. The light feeling especially conveyed by the essential design of the “inverted “L”- shaped feet, along with a single seat-cushion and a series of free cushions placed on the backrest is the distinctive feature of a sofa that has met with boundless success. The airy shape and simple profile make it, almost by contrast, extremely rich and innovative from a spatial standpoint, a system that encourages the creation of ever new compositions. Charles includes an extensive family of elements that can meet every furnishing requirement, even the most personal demand for comfort.

Technical information

Internal frame:

tubular steel and steel profiles

Internal frame upholstery:

Bayfit® (Bayer®) flexible cold shaped polyurethane foam, polyester fibre cover

Internal frame upholstery (CHP - CH150P):

shaped polyurethane of different density, polyester fibre cover

Seat cushion upholstery (home):

shaped polyurethane of different density, sterilized down, polyester fibre cover

Seat cushion upholstery (public spaces):

shaped polyurethane of different density, polyester fibre, polyester fibre cover

Back cushion (CH48_C-CH72_C):

upholstery : polyester fibre, typology : box style

Feet:

bronzed nickel painted, bright brushed or painted black chrome die-cast aluminium

Ferrules:

thermoplastic material

Cover:

fabric or leather

Technical drawings

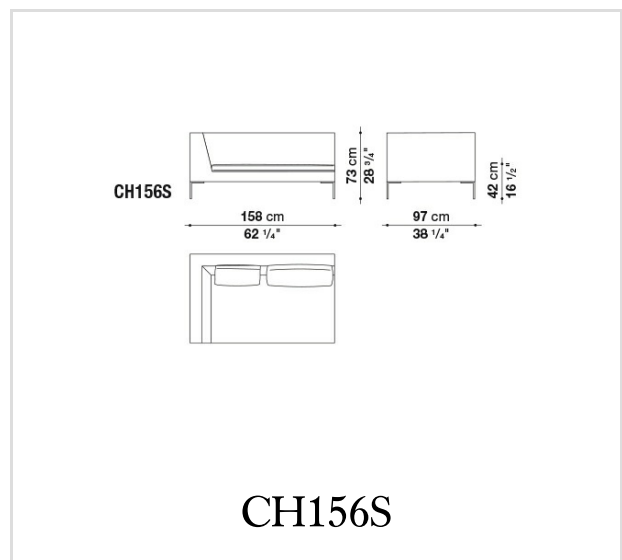
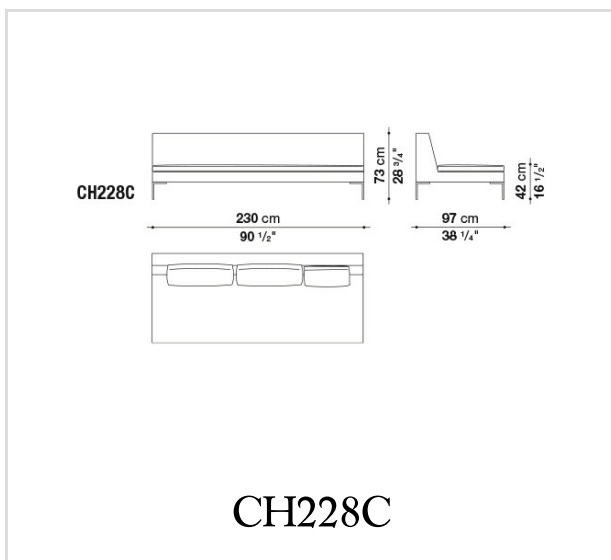
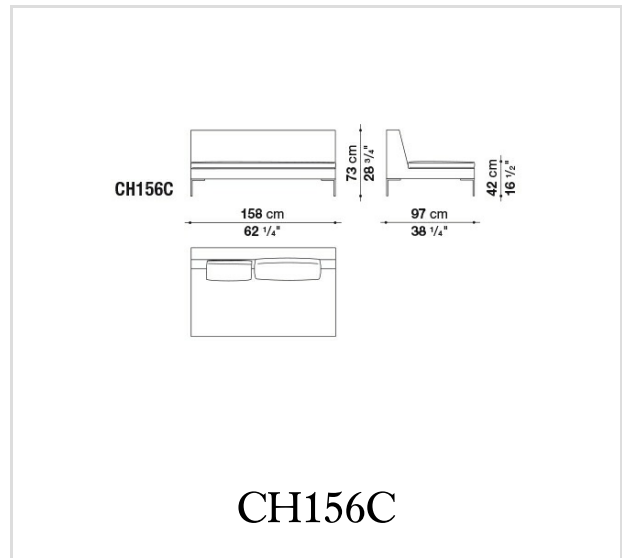
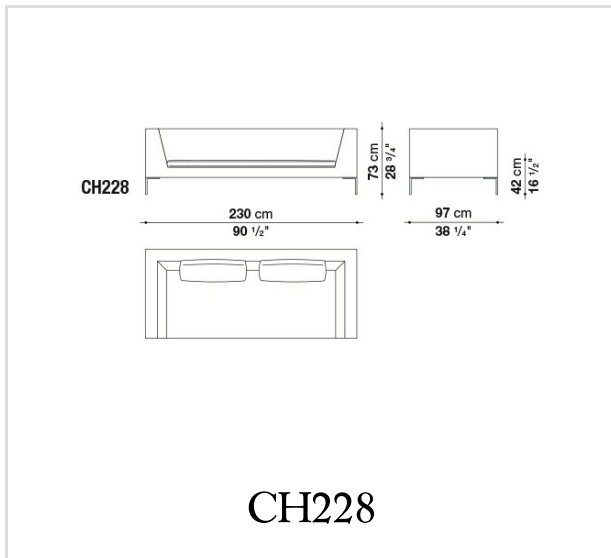

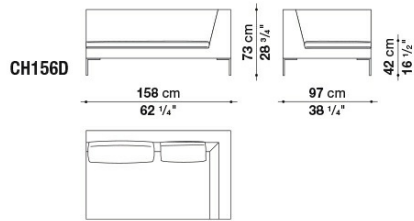

CH156D

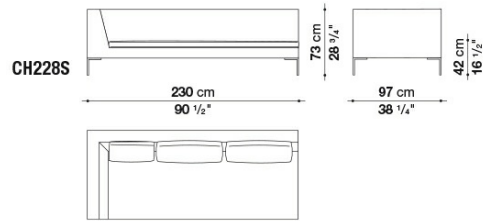

CH228S

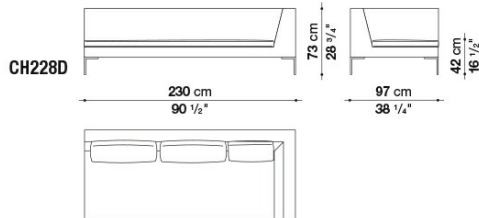

CH228D

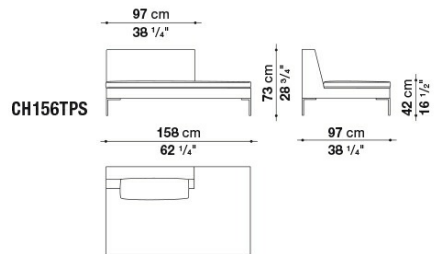

CH156TPS

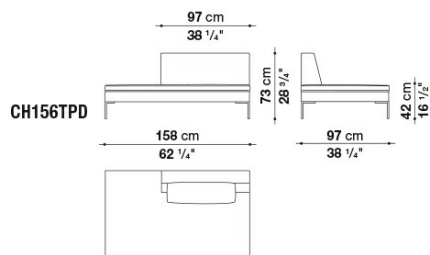

CH156TPD

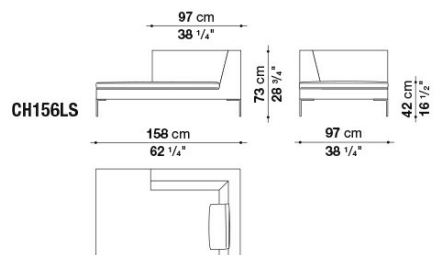

CH156LS

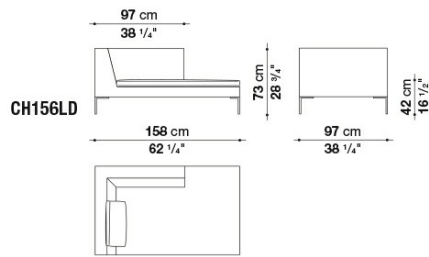

CH156LD

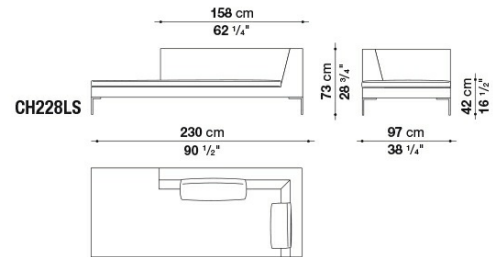

CH228LS

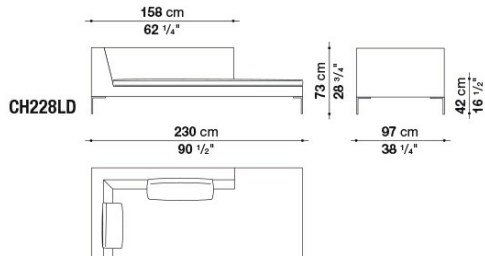

CH228LD

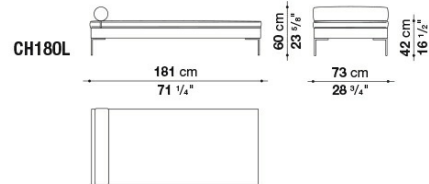

CH180L

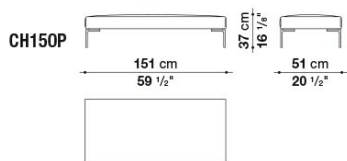

CH150P

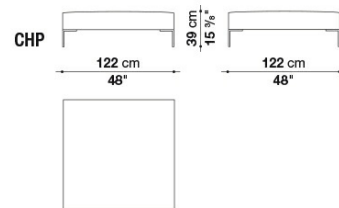

CHP

B&B Italia reserves the right to make technological and aesthetic improvements to its models, including changes to the sizes and materials, without notice. The technical drawings do not define the details of the product. The measurements shown are indicative and may undergo changes. In particular, the dimensions relevant to the padded parts are subject to usage tolerances over time caused by the normal adjustment of the padding. For the specific information, please contact the dealer closest to you.