

---

# Michel Club

SOFAS

*Antonio Citterio*



## Description

Michel Club is an evolution of Michel seating system. Orientation towards a technical and formal typology that resizes proportions of the frame and the cushions makes Michel Club a more traditional yet contemporary design proposal. Its 36 modular elements, 5 ottoman and linear sofas allow for a wide range of configurations. Comfortable back cushions with a headrest and additional cushions in various sizes make the seating relaxing or suitable for conversation, but always comfortable and very elegant. Michel Club is available in a wide range of fabrics and leathers from the B&B Italia collection. Combining different textures and colours allows an even greater level of personalisation of this seating system.

---

## Technical information

**Back and armrest internal frame:**  
tubular steel and steel profiles

**Back and armrest internal frame upholstery:**  
Bayfit® (Bayer®) flexible cold shaped polyurethane foam, polyester fibre, polyester fibre cover

**Seat internal frame:**  
painted tubular steel and steel profiles, multilayered wood panel, shaped polyurethane

**Seat cushion upholstery:**  
shaped polyurethane of different density, sterilized down, polyester fibre cover

**Back cushion (C65C-C50C):**  
upholstery : down feather + polyurethane section, typology : box style

**Back cushion with roller (C65CP-C50P):**  
upholstery : down feather + polyurethane section + polyester fibre, typology : box style + roller

**Support frame:**  
painted black chrome, pewter painted, bronzed nickel painted or bright brushed die-cast aluminium and extrusions

**Ferrules:**  
thermoplastic material

**Cover:**  
fabric or leather

# Technical drawings

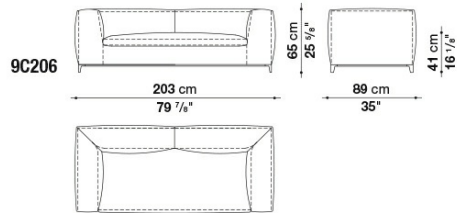

9C206

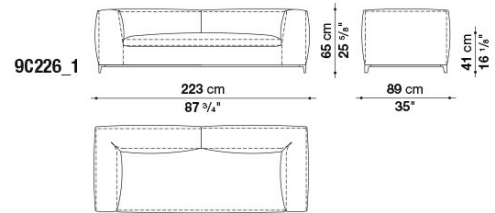

9C226\_1

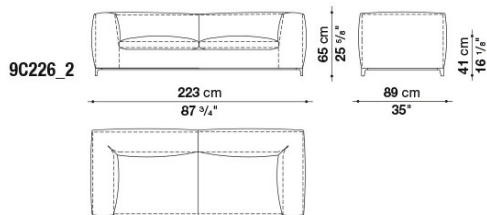

9C226\_2

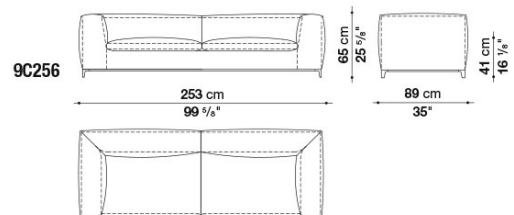

9C256

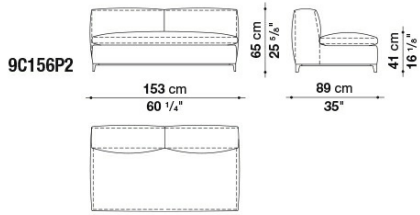

9C156P2

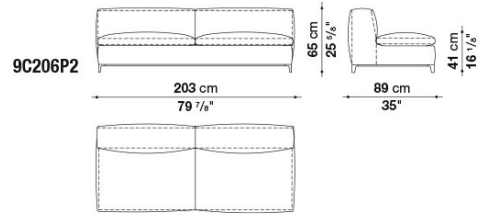

9C206P2

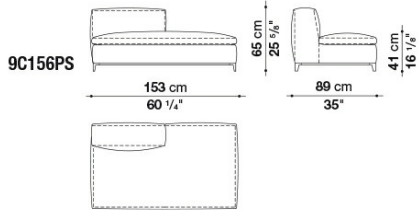

9C156PS

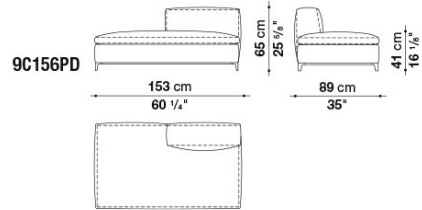

9C156PD

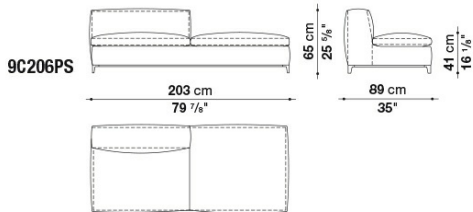

9C206PS

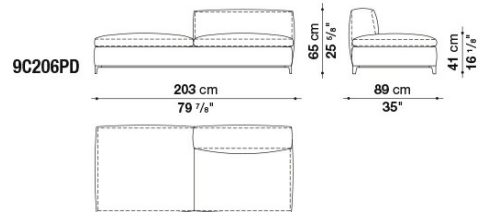

9C206PD

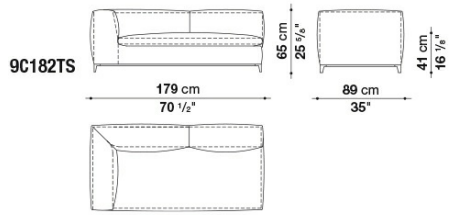

**9C182TS**

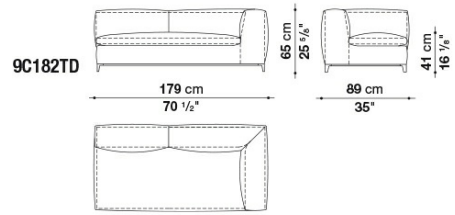

**9C182TD**

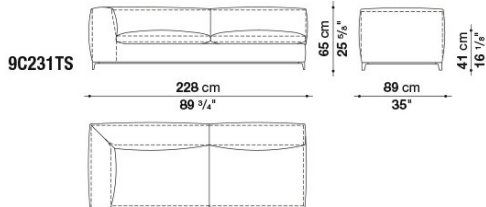

**9C231TS**

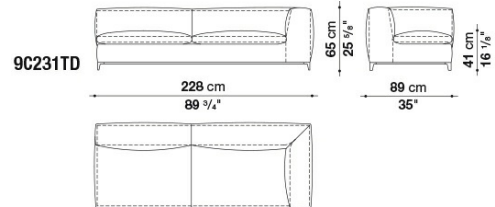

**9C231TD**

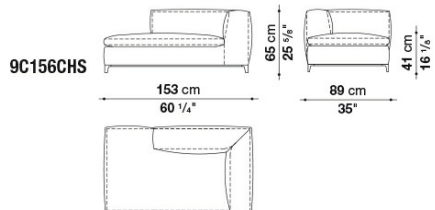

**9C156CHS**

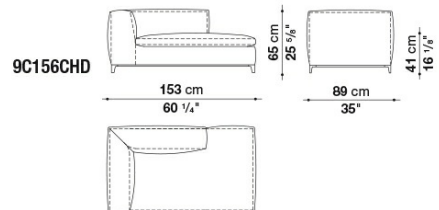

**9C156CHD**

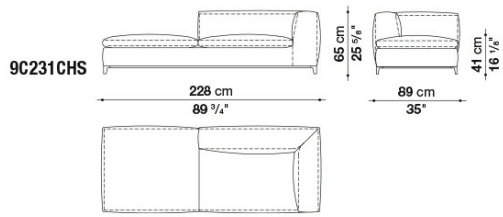

9C231CHS

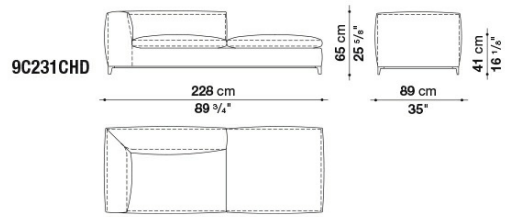

9C231CHD

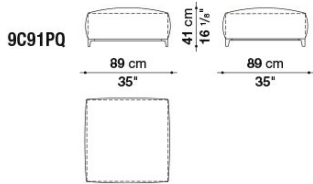

9C91PQ

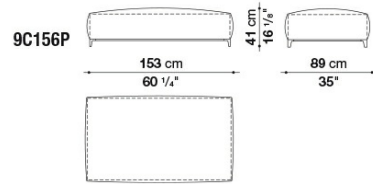

9C156P

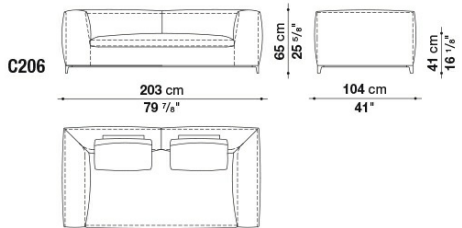

C206

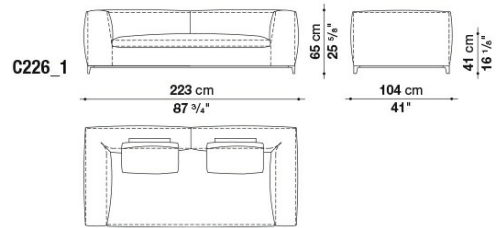

C226\_1

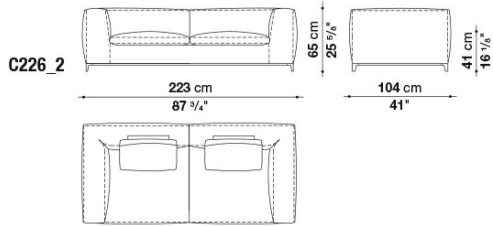

**C226\_2**

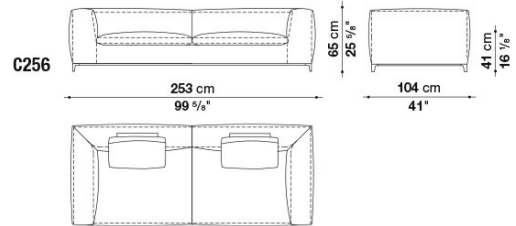

**C256**

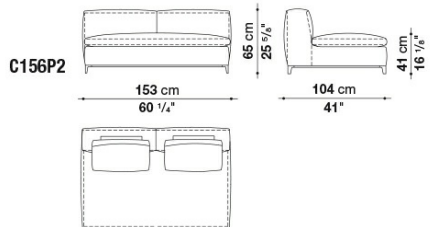

**C156P2**

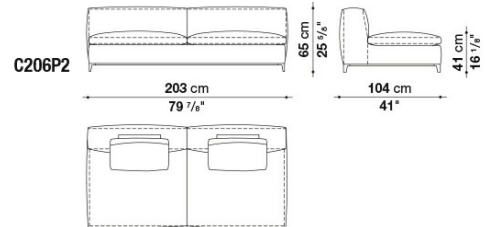

**C206P2**

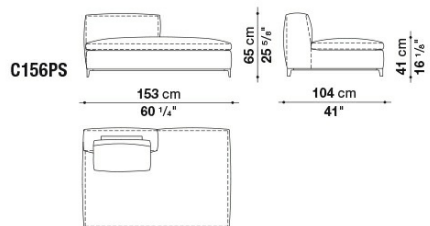

**C156PS**

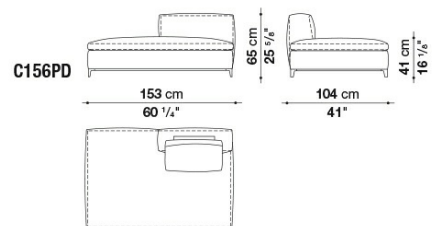

**C156PD**

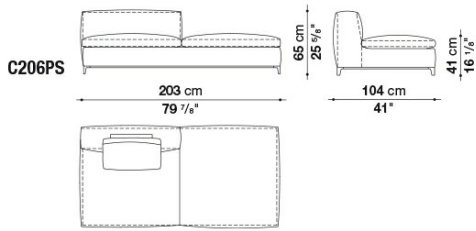

C206PS

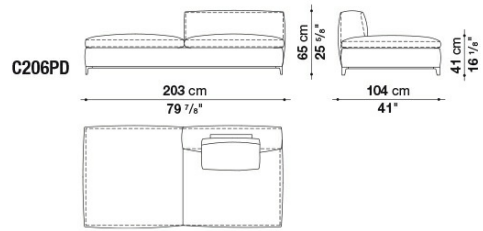

C206PD

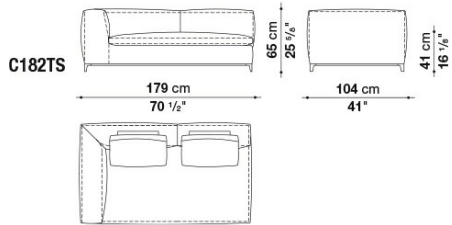

C182TS

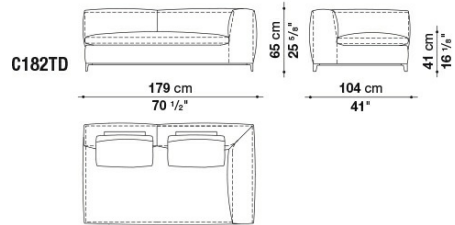

C182TD

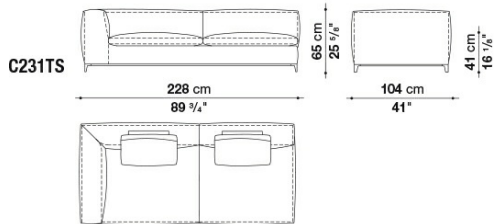

C231TS

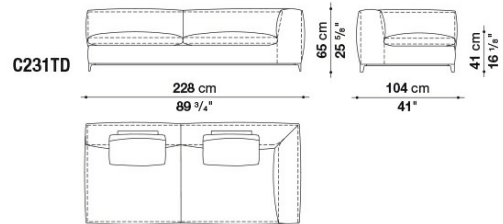

C231TD



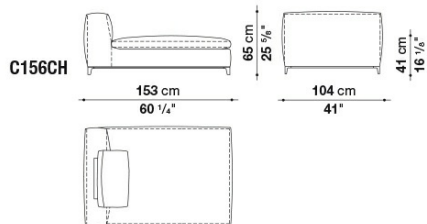

**C156CH**

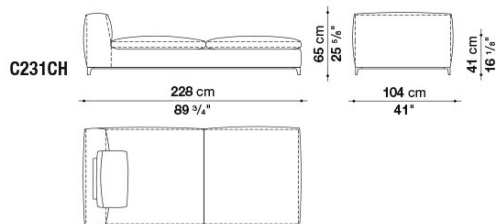

**C231CH**

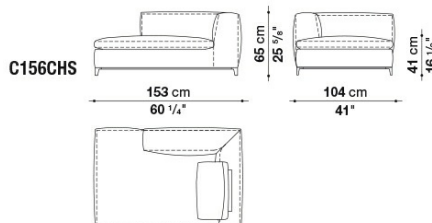

**C156CHS**

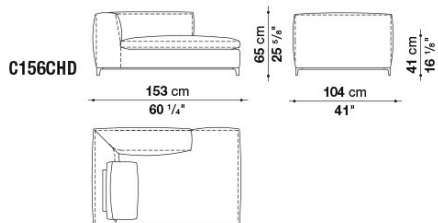

**C156CHD**

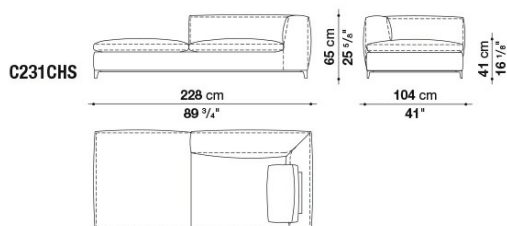

**C231CHS**

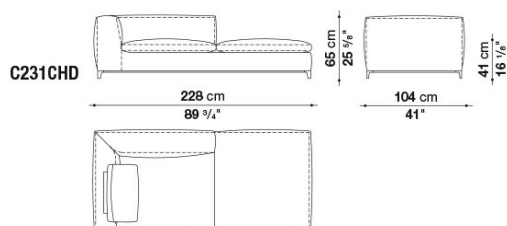

**C231CHD**

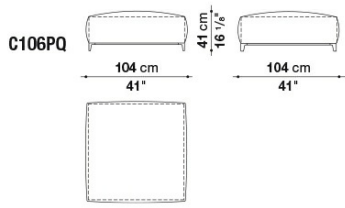

C106PQ

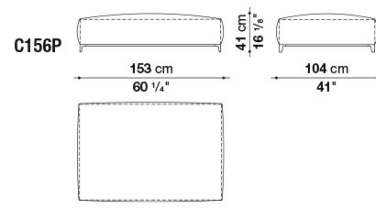

C156P

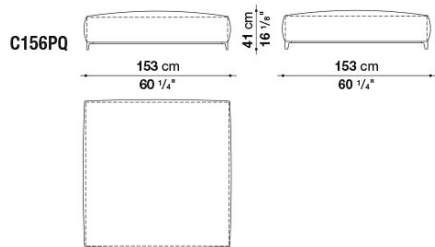

C156PQ

---

# Compositions

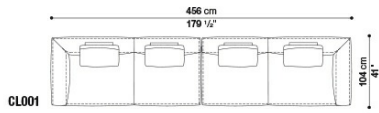

01

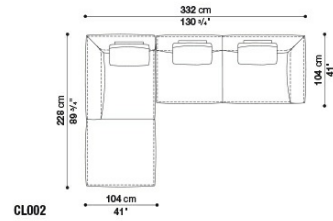

02

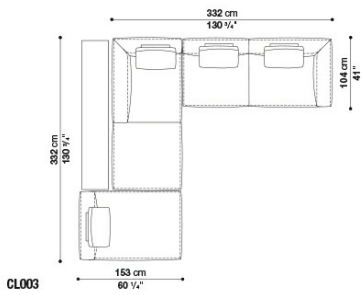

03

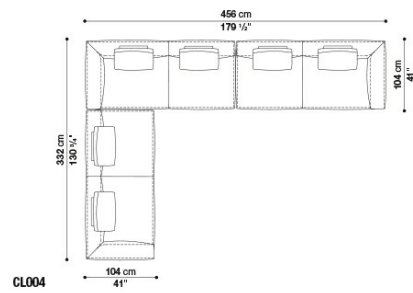

04

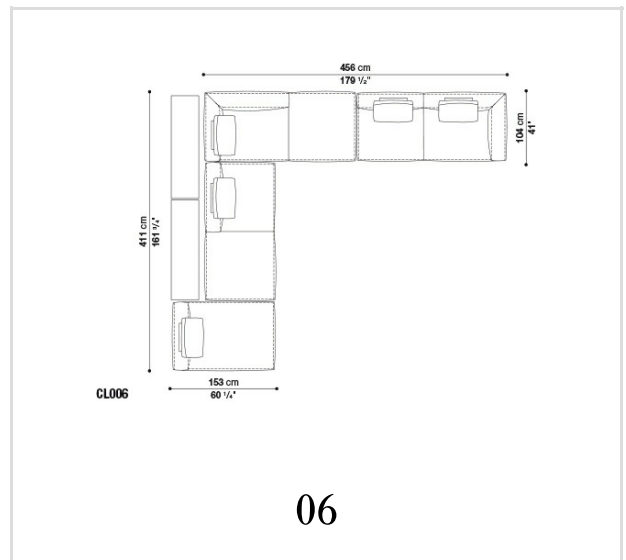
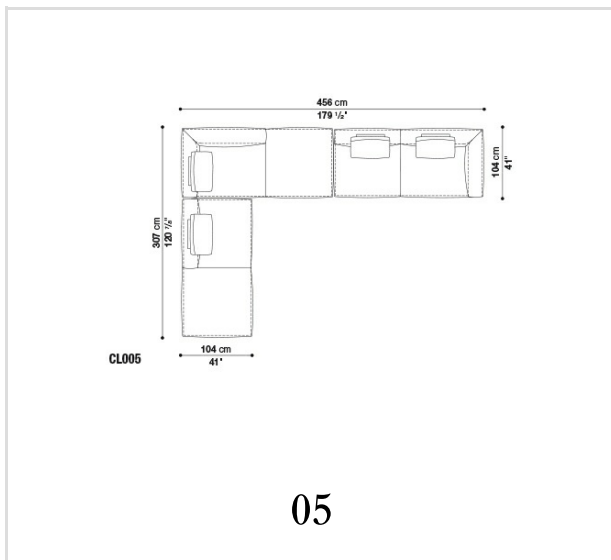

B&B Italia reserves the right to make technological and aesthetic improvements to its models, including changes to the sizes and materials, without notice. The technical drawings do not define the details of the product. The measurements shown are indicative and may undergo changes. In particular, the dimensions relevant to the padded parts are subject to usage tolerances over time caused by the normal adjustment of the padding. For the specific information, please contact the dealer closest to you.