

---

# Ravel

SOFAS

*Patricia Urquiola*



## Description

The result of field experimentation in the field, Patricia Urquiola's work marks another visitation of the interlacing theme. Interlaced backs in polyethylene fibre matched with base in galvanized steel with polyester powder painting produce a modular element of two different sizes. The pieces can be easily combined to form linear, corner, terminal elements or chaise longue. The ottoman-small table pieces can be used between seats, or to add depth to sofas.

---

## Technical information

Back frame:  
aluminium

Seat frame:  
galvanized steel

Frame finish:  
polyester powder painting

Interlacing:  
polyethylene

Seat cushion:  
shaped polyurethane, cover in water repellent polyester fibre

Back cushion:  
polyester fibre, cover in water repellent polyester fibre

Service element top (TR90):  
HPL laminate

Ferrules:  
thermoplastic material

Cover cloth:  
polyester on synthetic support

Cover:  
fabric in limited categories

# Technical drawings

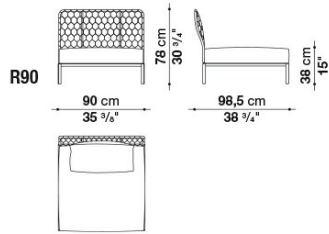

R90

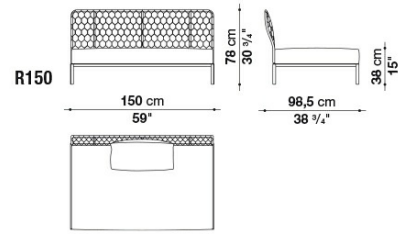

R150

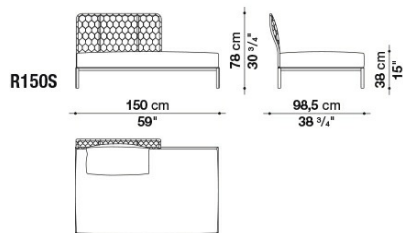

R150S

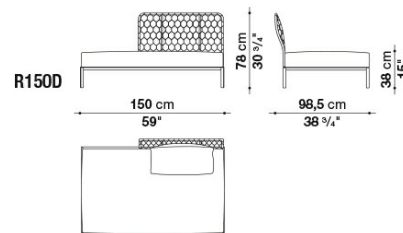

R150D

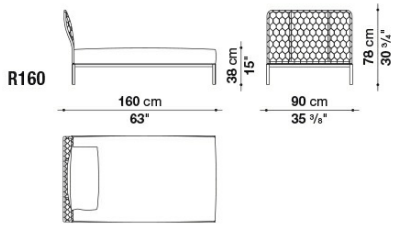

R160

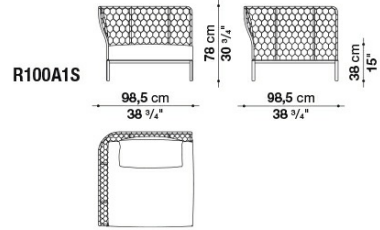

R100A1S

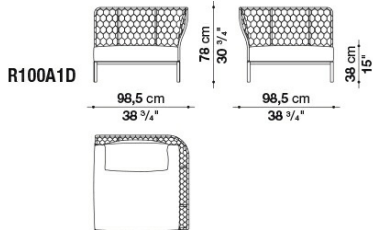

R100A1D

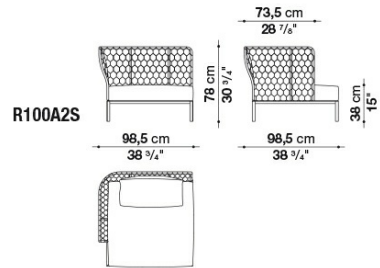

R100A2S

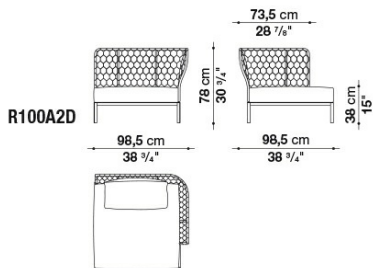

R100A2D

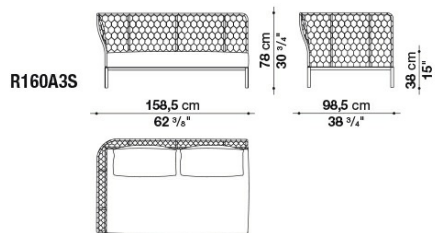

R160A3S

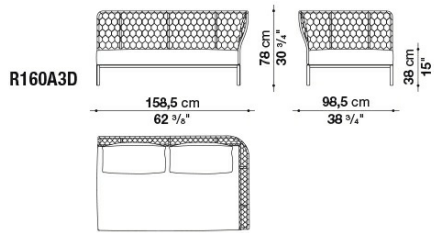

R160A3D

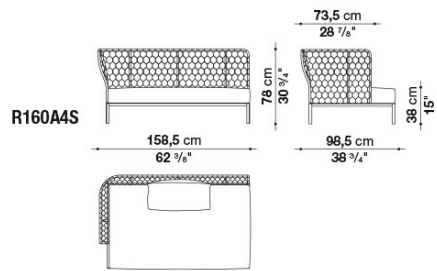

R160A4S

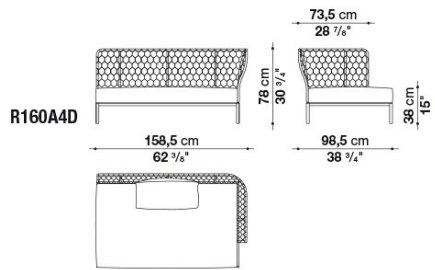

R160A4D

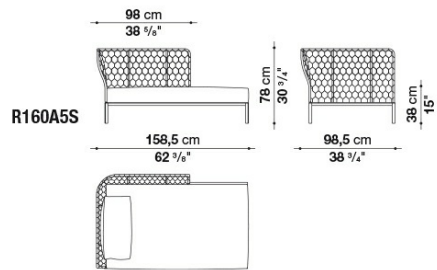

R160A5S

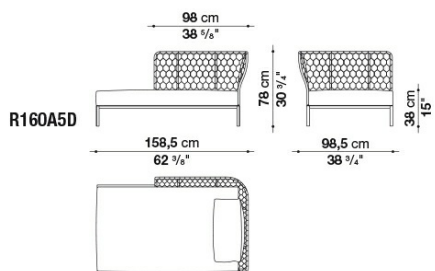

R160A5D

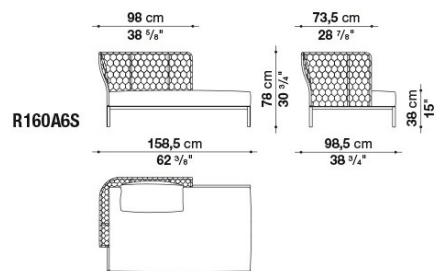

R160A6S

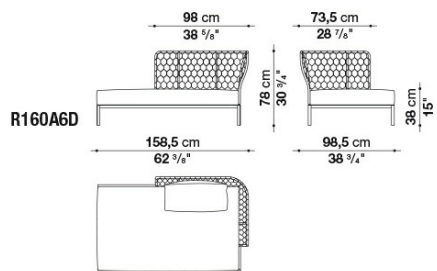

R160A6D

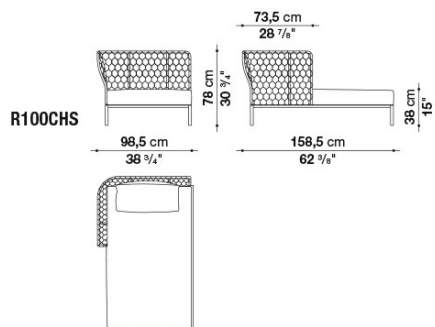

R100CHS

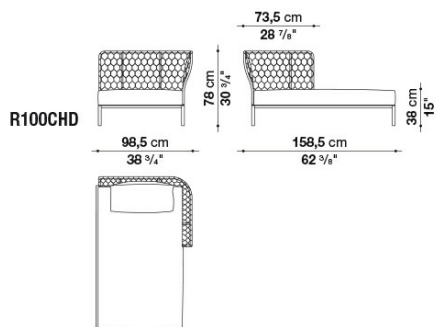

R100CHD

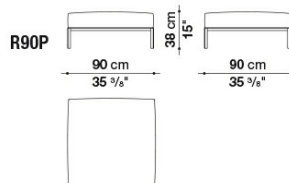

R90P

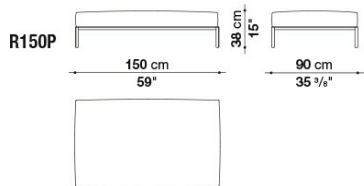

R150P

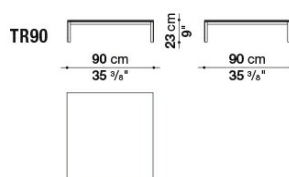

TR90

# Compositions

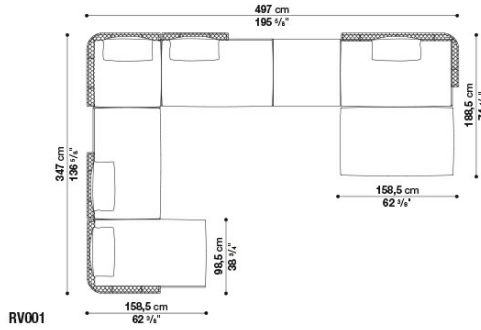

01

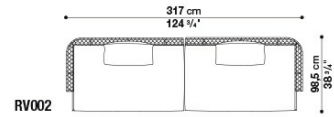

02

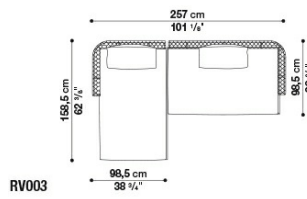

03

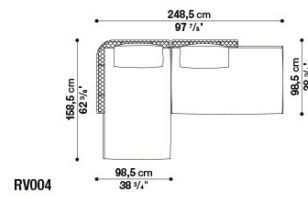

04

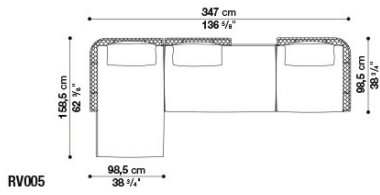

05

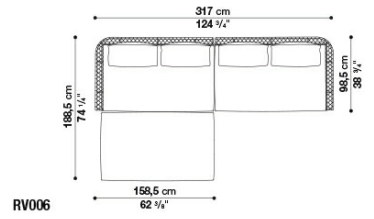

06

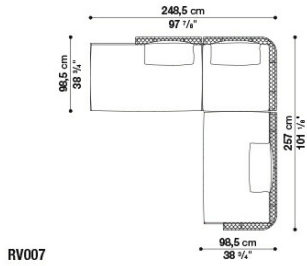

07

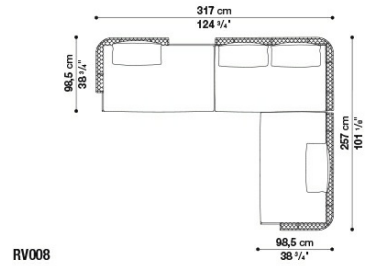

08

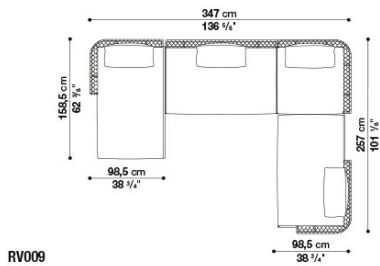

09

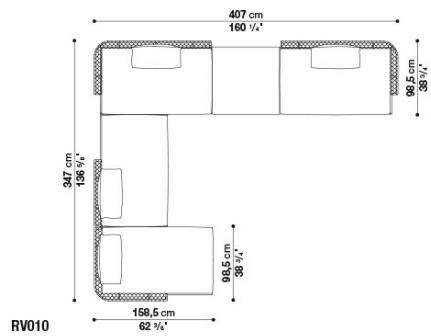

10



---

B&B Italia reserves the right to make technological and aesthetic improvements to its models, including changes to the sizes and materials, without notice. The technical drawings do not define the details of the product. The measurements shown are indicative and may undergo changes. In particular, the dimensions relevant to the padded parts are subject to usage tolerances over time caused by the normal adjustment of the padding. For the specific information, please contact the dealer closest to you.